



2020  
Catalog®

**GRIZZLY JIG COMPANY**

Nation's Largest Crappie Store

# SPORTSMAN'S Resort

All Crappie Masters  
Anglers  
Ask For Special  
Rates!

Boat Rentals  
Live Bait & Tackle  
Minnows Sold by  
Pound  
R.V. Parking

TWO GREAT LAKE FRONT LOCATIONS!

NORTH & SOUTH

Club house at each location that  
is ideal for large groups!

## THE QUAKE LAKE

REELFOOT LAKE, TN

(731) 253-6581

sportsmansresort@reelfootlake.com

100 Sportsman Resort Ln • Tiptonville, TN 38079

[www.reelfootlake.com](http://www.reelfootlake.com)

## 2020 RATES FISHING PACKAGE

2 Days  
&  
2 Nights **\$149.00** Per  
PLUS TAX Person

\$50 Deposit Per Person - Non-Refundable  
Year round special - Includes Boat, Motor,  
Gas, Bait, Lodging - Minimum 2 People  
Except March 19 - May 21

3 Days  
&  
3 Nights **FEB - AUG - NOV**  
**\$99.00** Per  
PLUS TAX Person

Sportsman's  
Resort  
"No Lose  
Proposition"

Sportsman's will match any  
advertised fishing package  
deal on  
Reelfoot Lake.  
Anytime of the year!

Taking Reservations Now! •  
Prices Subject to Change Without  
Notice

Nightly room rates available.

## DUCK HUNTING PACKAGE

2 Days • 2 Nights

Includes Lodging and 1 Meal  
**\$399.00 Per Person**

2019-2020 Season Rates

Call (731) 253-6581 or E-mail:  
sportsmansresort@reelfootlake.com  
for package pricing and guides.

**Year 'round R.V. spots available.**  
Full Hook Ups

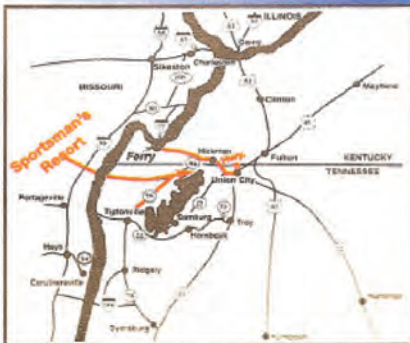

From Union City take Hwy. 5 to  
Hickman, KY  
12 miles South of Hickman, KY  
From Dyersburg take 78 North  
to Tiptonville  
10 miles North of Tiptonville, TN



**TO PLACE YOUR ORDER**

<b>TELEPHONE:</b> 1-800-305-9866	<b>MAIL:</b> 303 Ward Ave. Caruthersville, MO 63830
<b>FAX:</b> 573-333-9866	<b>STORE HOURS:</b> Monday - Saturday 7:00 a.m. - 5:00 p.m. CST
<b>WEB:</b> www.grizzlyjig.com	

**PLEASE NOTE:**

As you are aware, the United States levied tariffs on imported steel, aluminum, most items being imported from China, and more. These tariffs have caused significant price instability.

Grizzly Jig has made every attempt to provide a realistic list price. However, **we are not able to guarantee any list price in this catalog at any time.**

Thanks for your understanding during these uncertain times. We will make every attempt to keep our prices competitive.



www.bigrivercats.com

As the catfish industry is becoming more and more popular, we have partnered with some great companies in the industry and created our sister site.....www.bigrivercats.com. Check it out for all of your fishing needs to catch the "big one"!

**INDEX**

Rods.....4-39

Reels.....40-51

Lines and Floats.....52-60

Attractants.....61-63

*One Pole Jigging...Old Tactic Still Fun & Productive*  
by Tim Huffman.....64

Electronics.....65-69

Marine Products and Trailer  
Accessories.....70-77

Boat Seats and Mounts.....78-86

Rod Holders..... 87-95

*Mid-South Legend: Louie Mansfield*  
by Joe Sills.....96

Jigs, Soft Baits, and Crank Baits.....97-152

Terminal Tackle.....153-158

Aeration Systems, Nets, Traps and Wire  
Baskets.....159-167

Accessories.....168-176

Do-It Molds.....178-181

Catfish .....182-184

Clothing.....185-189

Publications and DVDs.....190-191

Cajun Fryers.....192

Order Blank.....193-194

**FIND US ON:**



# GRIZZLY ELITE PRO BALANCE SIGNATURE SERIES ROD

**NEW FOR 2020**



Item #  
PBR-104

- 10 ft.
- 2 pc.
- IM-7 Graphite

**\$59.<sup>99</sup>**

## THE CRAPPIE POLE

Formerly the Crappie Stick



**GRIZZLY JIG**  
Company

**High Quality IM7**  
A New  
Dimension Graphite

The Crappie Pole Features:

- Single Foot Ceramic Guides
- IM7 Hi-Modules Graphite
- Fixed Reel Seat
- EVA Foam Handles
- Super Lite, Super Sensitive, yet Tough
- All the bells and whistles as the original Crappie Stick.



Model	Size	Price	3 Poles
CPCS-102	10'	\$37.95	\$34.95
CPCS-112	11'	\$39.95	\$36.95
CPCS-122	12'	\$41.95	\$37.95

## Carolina Flippin Stick

By: The Crappie Pole

Flippin Sticks are specially designed with extra large guides at the bottom tapering to small guides at the tip. This IM-7 graphite blank is stiff and sensitive. Also features cork handle with graphite reel seat. Available in 7 1/2'.



Tip Sections Available  
Add "T" to rod number. **\$18.<sup>95</sup>**

Model	Size	Price	3 Poles
CFCS7	7 1/2'	\$35.95	\$32.95
TCFCS7	Tip Selection	\$17.99	

## GRIZZLY ELITE 13' HYBRID JIG ROD



Extra reach for LiveScope fishing!

**\$49.<sup>95</sup>**  
**Buy-3 • \$45.<sup>95</sup>**

	Item #	Length	Line Wt.	Rod Wt.
•IM-7 Graphite	GER-06	13'	#4-10 wt.	4.9 oz.
•11" EVA Foam Handle				
•Rear Fly Reel Seat				
•Ultra Light Weight				

Great for pads and open water snags.

Spare tip sections  
#GERTIP-\_\_  
**\$18.95**

To Order: [www.grizzlyjig.com](http://www.grizzlyjig.com)

# Grizzly Elite Rods



## GRIZZLY ELITE JIG-FLY ROD

- 98% high modulus graphite blank
- Cork handles for sensitivity
- Ceramic guides
- 3.7 oz
- Action light crappie
- Length 9'6" #4-5 wt



Extra tip sections -  
#GET 9'6"  
\$18.95

**\$48.95**

#GER-01

*This rod was designed for fishing the Cypress trees at Reelfoot Lake.*

*All Grizzly Elite Rods  
were designed by  
Grizzly Jig Company  
Caruthersville, MO*



Louie  
Mansfield

## GRIZZLY ELITE 3 PC - BRUSH ROD



IM-7 graphite

All Grizzly Elite Brush Rods are made from IM-7 graphite blanks • Comes with removable rod holder adapter • Portuguese cork handles • Ceramic guides • Line Keeper  
**Designed for extra heavy buck brush fishing.**

#GER-02-10'6" Heavy  
Length 10'6"  
Line Wt. #10  
Rod Wt. 4.6 oz.  
Price \$48.95  
3-Pole \$44.95

#GER-02-9'6" X-Heavy  
Length 9'6"  
Line Wt. #12  
Rod Wt. 4.5 oz.  
Price \$48.95  
3-Pole \$44.95

#GER-03-3 PC  
Length Combo  
10'6" Heavy and  
9'6" X-Heavy Tips  
Price \$59.95  
3-Pole \$54.95

TIPS  
GERTIP - 9'6"  
GERTIP - 10'6"  
\$18.95

## GRIZZLY ELITE 11' AND 12' JIGGIN RODS



Item #	Length	Line Wt.	Rod Wt.	Action
GER-04	11'	#6 wt.	5 oz.	Medium Crappie
GER-05	12'	#7 wt.	5.8 oz.	Medium Crappie

**\$49.<sup>95</sup>**  
Buy-3 • \$45.<sup>95</sup>

IM-6 graphite blanks • Removable rod holder adapter • Portuguese cork handles • Ceramic guides • Hook Keeper • Fire Orange Tip Section

Spare tip sections  
#GERTIP-\_\_  
\$18.95

To Order: 1-800-305-9866



**Dead Ringers**

**RODS**

**Trolling Series**



Model	Size	Pieces	Lure Wt.
DRR10-2	10'	2	1/32-3/4 oz.
DRR11-2	11'	2	1/32-3/4 oz.
DRR12-2	12'	2	1/16-1 oz.
DRR14-3	14'	3	1/16-1 oz.

**Family Priced**

**\$46.99 ea**

**Buy - 3**

**\$42.99 ea**

**Spare Tips  
\$18.95**

**Dead Ringers**

**Trolling Series Combo  
Slow Troll - Longline - Crank Bait**



Model	Size	Pieces	Lure Wt.
DRR10-2-C	10'	2	1/32-3/4 oz.
DRR11-2-C	11'	2	1/32-3/4 oz.
DRR12-2-C	12'	2	1/16-1 oz.
DRR14-3-C	14'	3	1/16-1 oz.

**Family Priced**

**\$54.99 ea**

**Buy - 3**

**\$49.99 ea**

**Grizzly Spinning Reel**

- 2BB
- Anti-Reverse
- Heavy Duty Bail
- Push Button Folding Handle
- 4.7:1 Ratio
- 180 yds/6# 130 yds/10#

**A Grizzly Jig Exclusive!!**

- IM-7 Graphite
- Hi-Vis Tip
- Moderate Action
- Larger Eyes to Accomodate Spinning Reels

**Bert Bennett**

**Signature Crappie Rods  
10' & 11' Ultra-Lite**



**\$46.<sup>95</sup>**

**Tip Section  
\$18.95**

#BB-102-10'  
#BB-112-11' **NEW**

- Ceramic Guides Including Micro Tip
- Removable Rod Holder Adapter
- IM-7 Graphite
- Cork Handles
- Our Lightest 10' and 11' Rods We Stock

# catfish rods & gear



## A. THE ORIGINAL Silver Cat - Brand New Look!

ITEM	LGTH.	TYPE	\$ EA	BUY 3
SCAT70S	7' /2PC	SPIN	28.95	26.95
SCAT80S	8' /2PC	SPIN	29.95	27.95
SCAT70C	7' /2PC	CAST	29.95	27.95
SCAT80C	8' /2PC	CAST	32.95	30.95

Type Of Guides: Ceramic Insert

The Silver Cat series is made of 100% fiberglass, and offers many features only found in catfish rods at a much higher price point. The nylon cord grip will offer great, no-slip handling even with wet, slimy hands, and is durable enough for use in a rod holder. The super-slick ceramic guide inserts are framed by equally high-quality

aluminum oxide alloy and will provide smooth line flow for heavy lines. The graphite reel seat will accommodate any size reel, and will keep it tight to the rod for maximum sensitivity. Finally, the glow-in-the-dark tip will help you see the lightest of bites during night-time fishing. The Silver Cat is a medium action rod, with a sensitive tip to maximize your catfishing efforts. As with all of our products, we believe sensitivity is the key to catching more fish, regardless of the species.

## B. Silver Cat MAGNUM

ITEM	LGTH.	TYPE	\$ EA	BUY 3
MAG80C	8' /2PC	CAST	59.95	54.95
MAG70S	7' /2PC	SPIN	59.95	54.95
MAG10C	10' /2PC	CAST	69.95	64.95
MAG10S	10' /2PC	SPIN	69.95	64.95

Type Of Guides: Ceramic Insert

The Magnums are built on a unique blank made of a 90% carbon, 10% fiberglass blend for sensitivity and extra backbone. They feature a wrapped nylon cord grip for sure-handling; super-slick ceramic guides, and a 'cat-fishin'' tough graphite reel seat. These rods start with sensitivity

to the smallest nibble, and finish with the backbone you need to haul in the monsters. The Magnums feature an 8-foot 2-piece casting rod, a 7-foot 2-piece spinning rod, and the newest 10-foot models come in both spinning and casting configurations.

## C. Silver Cat Magnum PRO-STAFF BUMPING ROD

ITEM	LGTH.	TYPE	\$ EA	BUY 3
BMPRO70C	7' /1PC	CAST	62.95	57.95
BMPRO75C	7.5' /1 PC	CAST	68.95	62.95

Our monster catfish catching Bumping Rod just got better! This version provides a stiffer blank than the original and a stainless steel tip eyelet designed to handle the abuse that swifter current

and 80+ pound catfish put on it. Bumping is the fastest growing technique in catfishing and is a technique used a majority of the time by Pro fishermen on rivers like the mighty Mississippi.

## D. REDESIGNED SILVER MAGNUM 75

Our best-selling Magnum rod just got better!

ITEM	LGTH.	TYPE	\$ EA	BUY 3
MAG75Ch	7.5' /1PC	CAST	65.95	59.95

Guides: Stainless Steel

With the help of our Pro Staff, we have stepped up our Magnum 7.5 ft 1-piece rod. We have added a cork handle, aluminum reel seat, and solid steel eyes the entire length of the rod. No more

inserts popping out! This has become the favorite anchoring rod for our Pro Staff and it will be yours as well!

## E. NEW! SILVERCAT ELITE

ITEM	LGTH.	TYPE	\$ EA	BUY 3
SCCL75C	7.5' /1PC	CAST	65.95	59.95
SCCL75S	7.5' /1 PC	SPIN	65.95	59.95

The all new Silver Cat Elite is made of E-glass composite material, which provides extreme strength and durability while catching huge cats. Designed for suspended drifting and anchoring, this rod

has a non-parabolic action that provides stiff backbone, but with a faster tip to see "hits" more clearly. The action of this rod is unique and will provide excellent visibility. Other prominent features of this rod are a double-nut locking reel seat made of aircraft grade aluminum, Hi-Vis tip - especially useful for night fishing, and a high quality X-Grip provides extra grip an improves rod aesthetics.



all-purpose rods



**ALL-PURPOSE RODS:**

**A. IM7 Graphite All-Purpose Crappie Wizard**

ITEM	LGTH.	TYPE	\$ EAC.	BUY 3
CW75	7.5/2PC	SPIN	46.95	42.95

Guides: Dyna-Flo

Designed by Richard Williams, a renowned guide on Kentucky Lake, these rods are constructed with high modulus IM7

graphite to provide a fantastic blend of strength and sensitivity for those who prefer a slightly stiffer action. The handle is made of genuine Portuguese cork for maximum sensitivity and a lightweight feel. Aluminum oxide spinning guides allow for great casting if that's your preference. This is a great all-purpose rod that will catch almost any species you desire. Spare Tip \$22.95

**B. Capps & Coleman All-Purpose & Wading Rod**

ITEM	LGTH.	TYPE	\$ EAC.	BUY 3
CCW82	8'2PC	SPIN	49.95	45.95
CCW92	9'2PC	SPIN	53.95	48.95

Guides: Ceramic Inserts

A great rod for casting or dipping, with a slightly stiffer action designed for wade fishermen. Wading for crappie is one of the fastest growing techniques,

second only to trolling. These rods feature a bottom mounted reel seat made of genuine Portuguese cork, blank made of IM6 graphite, and they are a great blend of strength and sensitivity. A great all-purpose rod. Spare Tip \$19.95

**C. Sam Heaton Super-Sensitive - REDESIGNED!  
7-Foot Of Im-6 Graphite Strength And Sensitivity!**

ITEM	LGTH.	TYPE	\$ EAC.	BUY 3
SHSS72n	7 FT/2PC	SPIN	42.95	38.95

Guides: Dyna-Flo

One of the lightest, strongest and most balanced jig poles anywhere is now better than ever. For the

smoothest casting and retrieval, the Dyna-Flo guides are now even larger, and the tough Cork-Knob handle provides superior balance and a great grip. One of the most popular rods on the water, the SHSS72n is still supple, strong and sensitive.

Spare Tip \$22.95

**D. Whitey Outlaw DOUBLE DUTY**

ITEM	LGTH.	TYPE	\$ EAC.	BUY 3
WOD10	10 FT/2PC	POLE	34.95	30.95
WOD12	12 FT/2PC	POLE	44.95	40.95

Guides: One Tip Guide, and One Tie-Down

The Outlaw Double-Duty Takes Fishing Back To The Basics It's a medium-action rod for big heavy hybrid bream, monster shellcrackers & any size crappie.

It's perfectly balanced with comfortable foam handle for all-day fishing. No reel needed, it's built on a tough & lightweight graphite blank, with one tie eyelet and one reinforced tie-down guide.

Spare Tip \$21.95

B'n'M Pro-Staff Developed & Tested!



To Order: [www.grizzlyjig.com](http://www.grizzlyjig.com)



# telescopic poles



## A. Vintage Little Jewel

ITEM	LGTH.	\$ EA	BUY 3
LJ9	9'	15.95	14.95
LJ10	10'	16.95	15.95
LJ11	11'	19.95	18.95
LJ12	12'	22.95	20.95

**BEST SELLER!** Makes catching them fun! Enhanced graphics. 100% fiberglass. Ultra lightweight. Fantastic action. Solid glass tip section, EVA foam handle. Reinforced joints. Line Keeper.

## B. Graphite Little Jewel

ITEM	LGTH.	\$ EA	BUY 3
GLJ10	10'	24.95	22.95
GLJ11	11'	29.95	27.95
GLJ12	12'	31.95	28.95

### Best Seller! Graphite!

This pole offers the same fun as its fiberglass sister, but the graphite construction allows more backbone with the same fantastic action. Ultra-Ultra Lightweight. Reinforced joints. EVA Foam Handle. Line Keeper.

## C. The Cadillac Combo

ITEM	LGTH.	\$ EA	BUY 3
FCDC102	10'	22.95	20.95
FCDC124	12'	25.95	23.95
FCDC145	14'	27.95	25.95

### Line-Through-Pole Convenience!

100% fiberglass. Lightweight. Well balanced. Extra long EVA handle, PLUS line-thru-the-center convenience. 30' mono w/swivel.

## D. Fish-Pole Reel Combo

ITEM	LGTH.	\$ EA	BUY 3
FPC102	10'	18.95	17.95
FPC123	12'	21.95	19.95
FPC143	14'	23.95	21.95

### Another Best Seller!!

100% fiberglass. Telescopic. Redi-rigged fish pole reel with 30' mono w/swivel. Line thru pole convenience. Includes wire threader.



To Order: 1-800-305-9866

## A. Buck's Graphite Jig Pole Spare Tip \$19.95

*Great features at a great price!*

ITEM	LGTH	\$ EA.	BUY 3
BGJP82n	8'	37.95	34.95
BGJP102n	10'	39.95	36.95
BGJP112n	11'	41.95	37.95
BGJP122n	12'	43.95	49.95

Type Of Guides: *Dyna-Flo*

14' and 16' trolling models available

The very-first graphite jig pole just got a great facelift and greater features. We improved and enlarged the guides - single-foot Dyna-Flo guides are lighter and more durable because of alloy construction and inserts. No more ceramic eyes popping out! The increased diameter of these guides will provide more versatility when pitching or flipping. The all-new reel seat keeps the reel tighter to the pole, allowing for more sensitivity. All of these new features (along with a new, flat-black finish) come to you at no extra charge.

## B. Buck's Gold Jig Pole

ITEM	LGTH	\$ EA.	BUY 3
GOLD102	10'	75.95	68.95
GOLD122	12'	79.95	72.95

Type Of Guides: *Dyna-Flo*

The shock-absorption reel seat provides outstanding feel and sensitivity and matches perfectly with the genuine Portuguese cork handle (no fake stuff). The rich, gold color indicates a rod of high quality...and that's exactly what we are delivering.

## C. Russ Bailey Signature Series

*A Great Rod - with a whole new look!*

ITEM	LGTH	\$ EA.	BUY 3
CWRB8	8'	51.95	46.95
CWRB10	10.5'	58.95	53.95

Type Of Guides: *Ceramic Insert*

A fixture in the crappie market for 2 decades, Russ is now host of the popular Brushpile Fishing TV show, the highest rated crappie show. This rod is made of high-modulus, secret recipe graphite (sensitive and strong), and has great rod aesthetics. Spinning guides on both lengths allows fishermen to cast this rod. This rod features stainless steel guides, line-depth markers placed in 1-ft increments and 100% pure Portuguese cork handle. Spare Tip \$22.95

**IM8 Graphite!** Spare Tip \$32.95  
30-ton, IM8 graphite means durability, stiffness and sensitivity like no other rod. Dyna-Flo spinning guides provide smooth casting and line retrieval, and allow this rod to be used in a number of popular techniques.

## D. Buck's Ultimate

*Our Premium Rod! IM6 Graphite!* 8' Spare Tip \$23.95  
10' Spare Tip \$27.95

ITEM	LGTH	\$ EA.	BUY 3
BULT82	8'	49.95	45.95
BULT102	10'	74.95	67.95

Type Of Guides: *Ceramic Insert*

As a casting, flipping or jig pole for Walleye, Bass or Crappie. Rig for live bait, spinning or jigging. Strong backbone, superior tip action. Super Stiff Action. Portuguese cork handle. 1-Footed Aluminum Oxide guides. Spinning Guides for superior casting ability.

## E. Sam Heaton - Super Sensitive

*Your Best Blend of Strength, Weight and Sensitivity!*

ITEM	LGTH	\$ EA.	BUY 3
SHSS92	9'	47.95	43.95
SHSS102	10'	54.95	49.95
SHSS112	11'	59.95	54.95
SHSS122	12'	69.95	63.95

Type Of Guides: *Ceramic Insert*

Available in 7' Spinning Model

We redesigned Sam Heaton's Signature Series into the Sam Heaton Super-Sensitive. Same great action with burgundy color, brass plated guides and a Portuguese cork handle. Made of IM-6 graphite (40 MSI), and aluminum oxide guides for smoother line flow and prevent line sticking. Tough, durable, with the action you expect from B'n'M and the most well-known crappie fisherman in the industry, Sam Heaton. Spare Tip \$23.95

## F. Sam Heaton Super-Sensitive with Bottom Seat and Touch System!

ITEM	LGTH.	\$ EA.	BUY 3
SHSSBS102	10'	53.95	38.95
SHSSBS112	11'	59.95	54.95
SHSSBS122	12'	64.95	58.95

Type Of Guides: *Dyna-Flo*

It's hard to improve one of the most popular crappie poles, but we did it! One of the finest jig poles anywhere, 40 MSI IM6 graphite is tough with the great sensitivity our customers have enjoyed from this series for years. By placing the reel seat at the bottom of the pole, this pole feels lighter due to its superior balance with any type reel. The genuine Portuguese cork handle resists heat and provides better comfort and sensitivity. The touch system allows direct contact with the rod for light bites. Looks great: ceramic inserts and brass plated aluminum oxide guides. Spare Tip \$23.95

## G. Buck's Custom Crappie Rod

ITEM	LGTH	\$ EA.	BUY 3
BCCR102	10'	48.95	44.95
BCCR112	11'	49.95	45.95
BCCR122	12'	54.95	49.95

Type Of Guides: *Ceramic Insert*

Made from the same blanks as our famous BGJP Series, but with a bottom mounted, fixed reel seat and a Portuguese cork handle. The bottom mounted reel seat adds superior balance, and you utilize the full length of the rod. Made of 96% Tubular graphite. Spare Tip \$18.95

## H. Buck's Best Ultra-Light

*Even lighter than BGJP!*

ITEM	LGTH	\$ EA.	BUY 3
BBUL10	10'	42.95	38.95
BBUL11	11'	43.95	39.95
BBUL12	12'	46.95	42.95

Type Of Guides: *Ceramic Insert*

96% Graphite Construction. NEW REINFORCED TIP SECTION. Fixed Reel Seat. Bends to perfect arc for "no-load" strength factor. 20" EVA foam handle. 2 section breakdown for easy travel and storage. Spare Tip \$20.95

## I. Buck's Best Ultra-Light with Bottom Seat and Touch System!

ITEM	LGTH	\$ EA.	BUY 3
BBULBS10	10'	44.95	40.95
BBULBS11	11'	45.95	41.95
BBULBS12	12'	47.95	43.95

Type Of Guides: *Ceramic Insert*

*Reduce the fatigue from jigging!*  
The lightest and most sensitive graphite pole on the market with new features! We took our BBUL series and added a bottom reel seat for perfect balance, and a "touch system" that allows you to have your fingers on the pulse of those light bites. This pole is more balanced, and feels lighter with any reel you choose (we're a bit partial to our BAN01 and BMR1). The touch system provides a better grip in addition to giving you another advantage when the strikes are light. Use this pole for vertical jigging once and it will be the last pole you ever purchase. Spare Tip \$20.95

## J. The Camo BrushCutter

*The Name Speaks for itself !*

ITEM	LGTH	\$ EA.	BUY 3
BRUX10c	10'	59.95	54.95
BRUX11c	11'	62.95	56.95
BRUX12c	12'	68.95	62.95

Type Of Guides: *Dyna-Flo*

The toughest crappie rod on the market now looks like it! If you are tough on your equipment, or if your lake requires you to place the rod tip in brushy areas, this is the rod for you. The BrushCutter Series now comes in a unique camouflage blank with IM6 graphite wrapped super-stiff construction. This rod will handle your needs in tough conditions and hoss out the slabs. Sensitive tip and EVA handle. Spare Tip \$29.95

## K. The Crappie Jack Combo

*The feel of graphite - the strength of fiberglass -- at a value price!*

ITEM	LGTH.	\$ EA.	BUY 3
CJ9	9'	28.95	26.95
CJ10	10'	29.95	27.95

Type Of Guides: *Stainless Insert*

With a blend of fiberglass/graphite composite material, this rod offers great performance and features at a great price. Partnered with our new vertical-mounted Quick-Change reel (#QC2) that allows you to change your line quickly by simply fitting a pony spool into the reel cradle (instructions included). The bottom reel seat offers great balance and blank-thru-handle action, and it even has a touch system like many of the premium rods on the market. Burgundy blank, EVA handle, and stainless steel guide inserts for durability and smooth line flow. Spare Tip N/A

**MORE JIG POLES →**



To Order: [www.grizzlyjig.com](http://www.grizzlyjig.com)

# jig poles



## L. Whitey Outlaw Santee Elite

ITEM	LGTH	\$ EA.	BUY 3
SE102	10'	41.95	37.95
SE112	11'	43.95	39.95
SE122	12'	49.95	45.95

This rod has no guides or eyes, and features a line thru the blank design. This rod will allow more aggressive fishing in heavy brush since there are no guides to get hung or tangled in brush. Provided with a wire threader for each customer. Line entry port mounted forward on blank allows you to easily pull line back when needed, and more easily detect slight and light bites. 90% graphite with EVA handle. Spare Tip \$20.95

## M. West Point Crappie Rod

ITEM	LGTH	\$ EA.	BUY 3
WPCR82	8'	23.95	21.95
WPCR10	10'	25.95	23.95
WPCR11	11'	29.95	27.95
WPCR12	12'	33.95	30.95

Type Of Guides: *Stainless Steel Insert*

### Old Favorite Gets A Make-Over...

This great classic rod has been a hallmark rod for B'n'M since Buck was a pup... Now with updated graphics and the same great features you trust: sensitivity, strength and durability! It's the perfect blend of composite graphite, stainless steel guides, a longer EVA handle, and perfect balance.

If you've fished the WPCR in the last few decades, you know what a great performer it is... Get one and leave the competition dripping in your wake!

Spare Tip \$13.95

## N. West Point Crappie Rod Combo

ITEM	LGTH.	\$ EA.	BUY 3
WPCOMB10n	10'/2PC	29.95	27.95
WPCOMB11n	11'/2PC	32.95	29.95
WPCOMB12n	12'/2PC	34.95	31.95

Guides: *Stainless Steel*

A great jig pole combo featuring one of our best-selling rods and the hottest line keeper reel on the market! This combo features the West Point Crappie Rod in 10, 11 and 12-foot models paired with Buck's Best Ultra Lite Crappie Reel 2. Great combo, great price!

Spare Tip \$13.95

## O. New! The TreeThumper

A blend of our lightest and strongest poles

ITEM	LGTH	\$ EA.	BUY 3
THUMP102	10'	52.95	47.95
THUMP112	11'	55.95	50.95

Weights almost exactly the same as our popular BBULBS series, but designed with enough strength to pull crappie out of tree tops. This is basically a cross between our

BBULBS and BRUX series. Made of secret recipe of hi-modulus graphite. This rod features ceramic inserts, a bottom reel seat, and a contoured handle made of 100% Portuguese cork. Spare Tip \$21.95

# ultra-lights

## A. The 410

A Lot Of Power Packed Into An Affordable, Small (M) UL Rod!

ITEM	LGTH.	\$ EA.	BUY 3
410	4'10"	12.95	11.95

Type Of Guides: *Ceramic Insert*

The all new 410 is a medium-ultra-light, fiberglass spinning rod that packs a lot of punch. This rod will provide a lifetime of enjoyment catching crappie and bluegill at your favorite fishing hole. Unlike most other

rods of this type, the 410 is a one-section rod which provides greater strength. And, this rod has more backbone allowing better hooksets. EVA handle. Ceramic-insert guides. Low price point.

## B, C. Slabtail Series

ITEM	TYPE	LGTH.	\$ EA.	BUY 3
SLT410S	SPIN	4'10"	25.95	23.95
SLT510C	CAST	5'10"	27.95	25.95

Type Of Guides: *Stainless Steel*

If ultra-light fishing is your preference, we have developed a rod you will love! The new Slabtail series is an extremely light, 1-piece UL rod with the fastest tip in the land. The buggy whip action of this rod, along

with the high quality stainless steel guides, will allow better castability with even the smallest of line and lures. Designed by Tom Mundy, owner of Fish Stalker Lures, these rods specialize in sensing the lightest of bites when the crappie and bluegill are lethargic. They are available in a 4 ft. 10 inch spinning model and a 5 ft. 10 inch bait-casting model. The bait-casting model features guides that wrap around the pole, allowing you to cast further, and with more accuracy with light tackle. Great price point. 100% fiberglass, with Genuine Portuguese cork handle.

## D. SharpShooter

ITEM	LGTH.	\$ EA.	BUY 3
SS45	4.5'	29.95	27.95
SS50	5.0'	31.95	28.95
SS55	5.5'	33.95	30.95

Type Of Guides: *Ceramic Insert*

### Great for shooting docks!

The SharpShooter series is a great ultra-light spinning rod, but is designed specifically for shooting docks. 100% graphite construction. Solid backbone, but with just the right amount of flexibility to launch the jig under the docks.

The Tennessee Handle (Portuguese cork with sliding rings) allows you to place the reel on the handle where you feel most comfortable (and most accurate) when shooting docks, and provides a snug fit. (Instructions for dock shooting included on the rod card). Single footed, strengthened alloy guides are accurately placed for sharp shooting. Teamed with our new West Point Spinning Reel (#BM050) or West Point Trigger Reel (DL1), you have a winning combination.

## E. SharpShooter DELUXE

ITEM	LGTH.	TYPE	\$ EA.	BUY 3
SSD60	6ft/1pc	SPIN	47.95	43.95

Guides: *Dyna-Flo*

A continued quest for the perfect dock shooting rod led us to the SharpShooter Deluxe. This rod has been field tested by our pro staff for the last year. The one

piece blank is made of extra stiff 98% graphite that provides longer and more accurate "shooting" of jigs as small as 1/64. The micro tip eyelet reduces line wiggle. The handle is made of Portuguese cork and has a fixed reel seat and touch system to provide superior feel for the lightest of bites. Dyna Flo guides for smooth line flow. Hook keeper. Though designed for dock shooting, this is an excellent all around spinning rod that matches well with our PRO100 reel.

## F, G. Buck's Graphite Crappie Rods

ITEM	LGTH.	TYPE	\$ EA.	BUY 3
SP55Gn	5.5FT/2PC	SPIN	34.95	31.95
SP80Gn	6 FT/2PC	SPIN	36.95	33.95
SP65Gn	6.5FT/2PC	SPIN	38.95	35.95
SC55Gn	5.5FT/2PC	CAST	31.95	28.95

Guides: *Ceramic Insert*

Designed with crappie and bluegill fishermen in mind, this newly redesigned series features more guides and a slightly stiffer action. Made of 96% tubular graphite and features

guides with ceramic inserts for smooth line flow and longer casts. The split cork handle provides excellent feel and balance, and the SC models feature a pistol-grip handle for easy casting and retrieval.

## F\* Buck's Graphite Crappie Combo

If you like a good fight, here's your weapon of choice!

Buck's Graphite Crappie Spinning Rod paired with a BM100 Reel -

ITEM	LGTH.	TYPE	\$ EA.	BUY 3
SP60GN-100-2	6.0 FT/2PC	SPIN	49.95	45.95

Guides: *Ceramic Insert*

This might be the Lightweight Champion Combo of the fishing world!

We've joined two title

contenders into an unbeatable pair - Buck's Graphite Spinning Rod and the custom-made BM100. This reel features three ball-bearings, instant anti-reverse, right- or left-hand retrieve, and is spooled with 8-lb test line. If you love the tussle of fishing for bream and crappie with lightweight gear, then this package gives you all the action you need - a high-quality package that's perfectly paired for years of dependable fun.

## H. Little Lucy

Big Performance In A Little Package

ITEM	LGTH.	\$ EA.	BUY 3
LL50	5 FT	16.95	15.95

Type Of Guides: *Ceramic Insert*

Here's the latest addition to our Ultra-Light category - and Little Lucy will find a spot that no other rod can hold. It's a 5-foot, 2-piece fiberglass honey that's a handy alternative to

longer, heavier rods. It's perfect for tight spaces (like under trees, and in your trunk), and Lucy makes bream fishing feel like you're tangling with a Florida bass. It's a great starter rod for your little fishing buddy, too! A great looking rod, with easy-visible gold finish and smooth-flowing guides.

# jig poles

# ultra-lights



To Order: 1-800-305-9866

## A. IM7 Graphite Crappie Wizard

ITEM	LGTH.	\$ EA	BUY 3
CW102	10'	52.95	47.95
CW122	12'	59.95	54.95

Type Of Guides: Ceramic Insert

### Spider Rigging at its Best!

Constructed with high modulus IM7 graphite to provide a fantastic blend of strength and sensitivity for those who prefer a slightly stiffer action. The handle is made of high grade EVA foam for durability, and aluminum oxide spinning guides allow for great casting if that's your preference. The extra-long painted tip allows for great visibility for even the softest of bites. Spare Tip \$22.95

Also available: 7½ ft. spinning model.

## B. Black Widow with Guides and Handle

ITEM	LGTH.	\$ EA	BUY 3
ST-3	10'	12.95	11.95
ST-4	13'	17.95	16.95
ST-5	16.5'	22.95	20.95
ST-6	20'	28.95	26.95

Designed specifically for trolling enthusiasts, but can be used as a spinning "bank" rod. This pole features ceramic shock ring guides, a unique snap-on reel seat, fluorescent yellow tip and textured handle. Snap-on reel seat to fit any reel, and fluorescent yellow tip to improve visibility of the lightest taps. 100% fiberglass. Available in various lengths for proper spider-rigging. Spare Tip N/A

## C. Pro Staff Trolling Rod

ITEM	LGTH.	\$ EA	BUY 3
PST082n	8'	31.95	28.95
PST102n	10'	41.95	37.95
PST122n	12'	44.95	40.95
PST143n	14'	49.95	45.95
PST163n	16'	54.95	49.95
*PST184	18'	71.95	64.95
*PST204	20'	83.95	75.95

Type Of Guides: Dyna-Flo  
\*Ceramic Insert Guides

### The Tournament Fisherman's Choice

This rod has a great blend of strength and tip action for even the most aggressive trollers. It was tested using two jigs spaced at various depths, a 5-oz sinker, and trolling speeds up to 2 mph. Stiff enough to withstand this aggressive style, yet sensitive enough to detect the slightest of nibbles. The reel seat is placed slightly upward on the 21 inch EVA handle to enable easy removal from any rod holder, yet allows ample room for your hand. Comes in 2, 3 and 4-piece configurations for easy storage. Spare Tip \$19.95

## D. Buck's Graphite Trolling Rod

ITEM	LGTH.	\$ EA	BUY 3
BGJP143n	14'	47.95	43.95
BGJP163n	16'	54.95	49.95

Type Of Guides: Dyna-Flo

### Every nibble is easily visible!

The tip action in these rods will ensure every nibble is easily visible, as it's the same action found on the number one crappie rod in the industry. Perfect for slow, vertical trolling before and during the spawn, these rods have

enough flex to sense the lightest bites. The lighter action will also keep your bait in the strike zone even when the winds have your boat rocking. The flex in these rods won't scare away a nibbling crappie, as the fish will feel little resistance when they pull away – until your hook is set and it's too late! Spare Tip \$18.95

## E. Capps and Coleman Trolling Rod

ITEM	LGTH.	\$ EA	BUY 3
CCT122	12'	49.95	45.95
CCT143	14'	53.95	48.95
CCT163	16'	63.95	57.95

Type Of Guides: Ceramic Insert

National Champion team of Ronnie Capps and Steve Coleman designed this rod with sensitivity in mind. Slightly stiffer than the BGJP series, these rods are perfect for pushing double minnow rigs yet still sensitive enough to detect light bites. They also have the flexibility to prevent crappie from spitting

out the bait by reducing the resistance when the crappie pulls on it. The enlarged bell shaped handle allows for depth adjustments of up to 6 inches without removing the rod from the holder. But, if you need to remove the rod from the holder, the offset reel seat will allow more versatility when putting the rod back. Spare Tip \$19.95

## F. POW-R-TROLLER

Trolling techniques continue to evolve...

ITEM	LGTH.	TYPE	\$ EA	BUY 3
PT143	14/3PC	SPIN	61.95	55.95
PT163	16/3PC	SPIN	69.95	63.95
PT184	18/4PC	SPIN	79.95	72.95

Type Of Guides: Stainless Steel

This rod is a heavy action trolling rod designed to hold heavier weights, up to 3 oz., with little bend in the rod tip. Made of high density graphite, these rods feature stainless steel guides and durable EVA

handle for the rigors of this aggressive technique. EVA handle has a rear-mounted rod "collar" to allow easy fit and securement into the rod holder.

The arbor-style gold tip eyelet ensures eyes do not pop out even when using heavier line weight. This, along with the hi-vis orange paint will allow fishermen to see the tip in any light conditions. Spare Tip \$21.95

# jigger poles/float&fly

## G. Ray Scott Jigger Pole

ITEM	LENGTH	\$ EA	BUY 3
RS145	14'	24.95	22.95
RS165	16'	27.95	25.95

Most folks know Ray Scott as the founder of B.A.S.S., but he is also a renowned historian on bass fishing. The Jiggerpole method for catching bass dates back to the 14th century, making it one of the oldest, and most

productive, fishing techniques known.

A long pole, a short amount of line, and literally moving the lure around the lily pads in shallow water. Water splashing on your face. What could be better?

A solid, yet flexible backbone is required on a 14 or 16 ft pole. And, to better protect your tip eyelet for this technique, we offer a unique tie-down/fold down eyelet which allows more tip stability and life, yet still allows the telescopic pole to be broken down. Get back to the basics of fishing with this great new pole! Spare Tip N/A

## H. The Float and Fly Rod

ITEM	LGTH.	\$ EA	BUY 3
FFCS8	7' 11"	56.95	51.95

Type Of Guides: Ceramic Insert

### The best rod available anywhere for Float and Fly fishing!

We consulted with the master of this technique, Tennessee guide Jim Duckworth, to develop the best rod available anywhere for Float and Fly fishing. (By the way, it also makes an excellent crappie rod!) Made of IM6 graphite, this is a tough, durable rod with excellent "feel", and will provide the exact parabolic action required for bait presentation.

The weighted handle system allows you to decide the best balance of tip and handle weight for custom castability. Want less weight on the handle? The weighted handle system is furnished with 2.5 ounces of weight to decide the best balance... Simply remove the brass plates on the handle by removing the cap and weights. Then, simply replace the cap. It's that simple! The shortened handle is made of genuine Portuguese cork and offers you more rod blank to get more casting distance, but remains tournament legal at 8 ft. We guarantee this will be the most versatile rod in your collection. Spare Tip \$19.95

## I. Tennesse Handle Float and Fly

ITEM	LGTH.	\$ EA	BUY 3
FFTH92	8' 11"	67.95	61.95
FFTH102	9' 11"	69.95	63.95

Type Of Guides: Ceramic Insert

### Constructed of IM6 Graphite!

Designed for the popular wintertime technique for smallmouth bass. These rods feature great action for the "10 to 2 technique", and offer a Tennessee handle for the angler to place reel anywhere for a personalized feel. Spare Tip \$19.95

# side-pulling rods

## J. "The Difference" by Roger Gant

Outstanding tip action!

ITEM	LGTH.	\$ EA	BUY 3
RG082	8'	42.95	38.95
RG092	9'	48.95	44.95
RG102	10'	52.95	47.95

Type Of Guides: Ceramic Insert

Designed by well-known guide Roger Gant (Pickwick, TN), the pioneer for the hottest new technique for crappie fishing, side-pulling. These rods offer the exact strength, sensitivity and action for an exact bait presentation when pulling from the side of the boat. Whether spider rigging, tight lining, or side pulling, the ability to see the lightest taps makes all THE DIFFERENCE! In fact, Roger Gant catches more crappie each year than anyone we know... and we know a lot of good fishermen! But, it also makes a great spinning rod and is fantastic for deep water jugging in tight areas, or wade-fishing. IM6 graphite blank for additional stiffness and sensitivity. Portuguese cork handle. High quality guides with ceramic inserts for smooth line flow. Spare Tip \$18.95



To Order: [www.grizzlyjig.com](http://www.grizzlyjig.com)

# trolling rods



# jigger poles float&fly



# side puller





duck commander series

## B'N'M AND DUCK COMMANDER: A NEW LEGACY!

When we learned that the Robertson family loved crappie fishing and were fans of B'n'M Poles, it was a natural fit to bring our great brands together. We're proud to bring you our custom line of "Duck Commander Crappie Rods and Poles".

Building on over 70 years of panfishing experience, we worked with "The Duck Commanders" to develop and test this series

of trolling, spinning, ultra-light and telescopic rods to their exact specifications.

As with every B'n'M product, we stand behind this entire series of rods with our Best-In-The-Industry Warranty for materials and workmanship.

They are outstanding, and we're sure you'll enjoy fishing along with us and the Robertsons for years to come.

### A. Duck Commander ULTRA-LIGHT Crappie Rod

ITEM	LGTH.	\$ EA	BUY 3
DCSPIN4	4'	22.99	20.99
DCSPIN6	6'	29.99	27.99

Guides: Dyna-Flo

- 40 MSI IM6 Graphite Blank
  - Genuine Portuguese Cork Handle.
  - Dyna-Flo Stainless Steel Guides
  - Chartreuse Depth-Monitoring Wraps
- Spare Tip \$17.95

### B. Duck Commander Trolling Crappie Rod

ITEM	LGTH.	\$ EA	BUY 3
DCTROLL122	12'	52.99	47.99
DCTROLL143	14'	59.99	54.99

Guides: Dyna-Flo

- 40 MSI IM6 Graphite Blank
  - Extra-Long Hi-Vis Painted Tip
  - Stiff Action
  - Dyna-Flo Guides
  - Chartreuse Depth-Monitoring Wraps
- Spare Tip \$31.95

### C. Duck Commander DOUBLE-TOUCH Rod

ITEM	LGTH	\$ EA	BUY 3
DCDT102	10'	48.99	44.99
DCDT112	11'	50.99	45.99
DCDT122	12'	52.99	47.99

Guides: Dyna-Flo

- 40 MSI IM6 Graphite Blank
  - Unique "Double-Touch" System
  - Genuine Portuguese Cork Handle.
  - Dyna-Flo Stainless Steel Guides
  - Chartreuse Depth-Monitoring Wraps
- Spare Tip \$26.95

## NEW FOR 2020!!

### THE STICK

- 13 ft.
- 2 pc.
- Action: Heavy
- Line Wt.: 4-12 lb.

#STICK123  
\$99.99

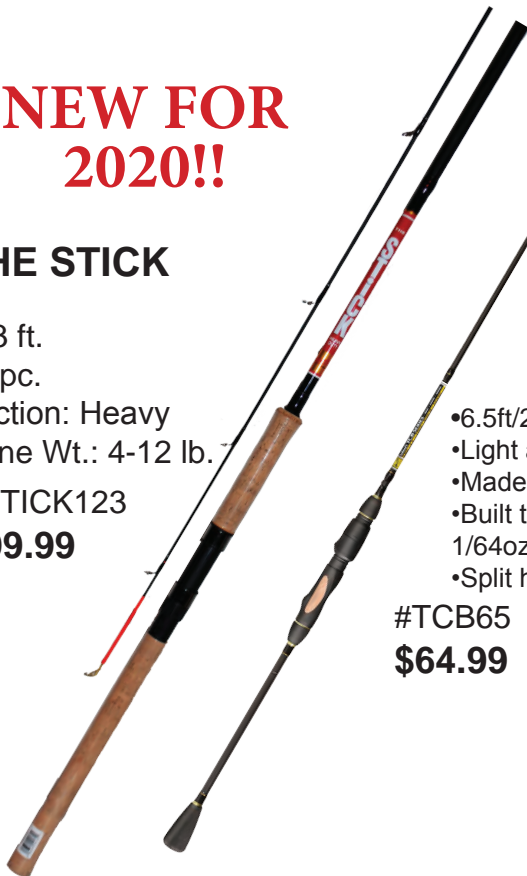

### Leland's TCB (Trout, Crappie, Bluegill) Rod

- 6.5ft/2pc rod
- Light as a feather
- Made of premium graphite
- Built to use lures as light as 1/64oz. on 2lb. test line
- Split handle with reel seat

#TCB65  
\$64.99

**B'n'M**

### Mossy Oak Edition Brushcutter

- Mossy Oak's Agua Blacktip pattern
- IM6 graphite
- EVA foam handle
- 20% more backbone than the original
- 2 pc

10 FT.  
#MOBRUX10  
\$59.99

12 FT.  
#MOBRUX12  
\$59.99





## GIGS N SPEARS

### Frog Gigs & Fish Spears *High quality, best sellers...*

Acetylene welded at the seams. Hand forged spring steel, needle-sharp points. Premium grade. Conveniently skin packed.

ITEM	TOTAL LGTH.	TOTAL WID.	TINE LGTH.	TINE DIA.	\$ EA.
6PK	7"	3 1/2"	3 1/2"	3/16"	10.99
8PK	10"	6"	6"	5/16"	18.99
30PK	8 3/8"	3 1/2"	3 1/4"	1/8"	5.99
55PK	8 3/8"	2"	5 1/4"	1/8"	11.99

(Commercial Frogger)



### Stainless Steel Frog & Fish Spears

#### Serious "Stickin' Power"

We re-created our most popular sized frog and fish spears in brilliant and durable stainless steel. They've been a big hit! Hand-forged to our specifications with needle-sharp points and barbs, these spears are a "lifetime investment" for the spear fisherman, and designed to perform for generations to come. Spear Handles not included.



ITEM	TOTAL LGTH.	TOTAL WID.	TINE LGTH.	TINE DIA.	\$ EA.
4XPKS	7"	3 1/2"	4"	3/16"	19.95
6PKS	7"	3 1/2"	3 1/2"	3/16"	22.95
7PKS	8 1/2"	5"	5"	1/4"	24.95

## MINNOW RIGS AND MORE

### Capps and Coleman Minnow Rigs

Catch crappie like Eight-Time National Champions Ronnie Capps and Steve Coleman! This is the exact rig used by the team that has garnered over \$1.3 million in tournament winnings and has been named Angler Team of the Year SEVEN times. These rigs are precision tied for the best balance to minimize line twist and create a near perfect live bait presentation. Each rig is created for your exact need to catch crappie at any depth or trolling speed throughout the year. The Eagle Claw #2 Type 214 EL hooks (2 on each rig) will minimize lost fish.... and lost rigs from snagging. Choose your rig based on the depth you desire to fish, tie to your line, and you're ready to go.

ITEM#	WEIGHT	LINE	TOP LENGTH (FROM SWIVEL)	BOTTOM LENGTH (FROM SWIVEL)	TROLLING WATER DEPTH	\$ EA.
MR14	1/4 oz	10 lb	8.5 inches	20 inches	2 - 7 ft	<b>8.50</b>
MR38	3/8 oz	10 lb	8.5 inches	20 inches	2 - 7 ft	<b>8.95</b>
MR12	1/2 oz	12 lb	9 inches	22 inches	7 - 12 ft	<b>9.95</b>
MR34	3/4 oz	15 lb	1 inches	28 inches	12 - 18 ft	<b>10.95</b>
MR10	1 oz	15 lb	11 inches	32 inches	18 - 25 ft	<b>12.95</b>

Note: All bottom lengths are measured from swivel to sinker. There is an 8" leader from sinker to hook #2, but your trolling speed will determine exact depth.



SIX RIGS PER PACK

### Slabmaster Crappie Saver

**Oversized Design:** Current crappie checkers on the market have one major flaw: they simply aren't big enough! Our oversized checker allows measurement up to 16 inches.

**Air Bladder Deflation Guide:** Keeping your fish alive until tournament weigh in is a challenge. Your best bet is to deflate the air bladder. But, where is the air bladder? Easy: Simply place your crappie into the Slabmaster Crappie Saver, and measure the length. Keeping the fish properly aligned in the checker, take your length measurement and correspond it to the ADG. Insert a needle (at a 45 degree angle), and press. The air bladder is deflated, and the fish wins you that coveted championship.



**Estimated Weight:** Find the approximate weight of your fish.

**Estimated Age:** Estimate the age of your fish based on years of exhaustive research. You'll be surprised at how long it takes a crappie to reach 3 pounds!

Made of extremely durable ABS plastic, in easy-to-see orange.

ITEM: LCC1      **\$12.95**



Serious about your fishing? ... Get an Ozark!

- IM-7 Graphite
- EVA Handles
- Stainless Steel Guides



**PRO SERIES**

Item	Length	Action	PC	Handle	Price	Buy-3
PS1002CF-GREY	10'	Jigging	2	EVA	\$59.99	\$54.99
DS701S	7'	Dock Shooter	1	Cork	\$49.99	\$45.99
JP802M	8'	Jigging	2	Cork	\$49.99	\$45.99
JP902M	9'	Jigging	2	Cork	\$49.99	\$45.99
JP1002M	10'	Jigging	2	Cork	\$52.99	\$47.99
JP1102M	11'	Jigging	2	Cork	\$55.99	\$50.99
JP1202M	12'	Jigging	2	Cork	\$59.99	\$54.99
CS1002ULS	10'	Ultra Lite	2	Cork	\$49.99	\$45.99

**PRO SERIES TROLLING ROD**



Item	Length	Action	PC	Handle	Price	Buy-3
CS1202TR	12'	Trolling	2	EVA	\$56.95	\$51.95
CS1403	14'	Trolling	3	EVA	\$59.95	\$54.95
CS1603	16'	Trolling	3	EVA	\$69.95	\$63.95

**POWER TROLLING ROD**



Item	Length	Action	PC	Handle	Price	Buy-3
PT1202TR	12'	Heavy/Trolling	2	EVA	\$56.95	\$51.95
PT1403TR	14'	Heavy/Trolling	3	EVA	\$59.95	\$54.95
PT1603TR	16'	Heavy/Trolling	3	EVA	\$69.95	\$63.95

**BRUSH BUSTER CAMO**



Item	Length	Action	PC	Handle	Price	Buy-3
BB1002M	10'	Heavy/Jig	2	Cork	\$52.99	\$47.99
BB1102M	11'	Heavy/Jig	2	Cork	\$56.99	\$51.99
BB1202M	12'	Heavy/Jig	2	Cork	\$59.99	\$54.99

**SIGNATURE SERIES REAR SEAT**



Item	Length	Action	PC	Handle	Price	Buy-3
SS902R	9'	Jigging	2	Cork	\$44.95	\$39.95
SS1102R	11'	Jigging	2	Cork	\$44.95	\$39.95

**LADIES SIGNATURE SERIES PINK**



Item	Length	Action	PC	Handle	Price	Buy-3
SS6601SP	6'6"	Lite	1	Cork	\$39.95	\$36.95
SS1002SP	10'	Medium	2	Cork	\$39.95	\$36.95
SS1102SP	11'	Lite	2	Cork	\$39.95	\$36.95
SS1002RP-REAR	10'	Lite	2	Cork	\$39.95	\$36.95
SS1102RP-REAR	11'	Lite	2	Cork	\$39.95	\$36.95

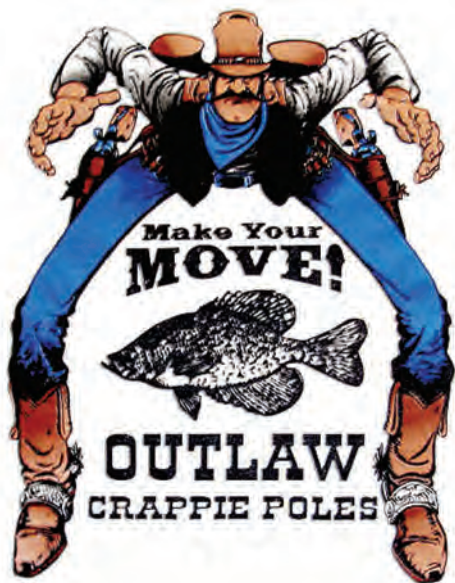

## Outlaw Cork Handle Poles

Crappie - - - Walleye



EXTRA TIP WARRANTY BY OUTLAW

Item #	Description	Price	3 or more
C-7.2	7'2" 2 pc Black Tip	\$54.95	\$49.95
C-8.2	8'2" 2 pc with Green Money Tip	\$54.95	\$49.95
C-1002*	10' 2 pc. with Green Money Tip	\$57.95	\$52.95
C-1102	11' 2 pc. with Green Money Tip	\$64.95	\$58.95
C-1202	12' 2 pc. with Green Money Tip	\$65.95	\$59.95
F-143	14' 3 pc. with Green Money Tip	\$76.95	\$69.95

Strong backbone and superior tip action, lightweight IM-7 graphite, black two piece rods designed for casting, flipping, jigging, and trolling. All have high quality guides, fixed reel seats and come with the famous Outlaw Green "Money Tip." Cork handles for superior sensitivity. Perfect for pulling slab crappie out of thick brush.

\*10' rod is brown.



*KingHawk Crappie Casting Rods (10'-12') are the perfect rods for crappie anglers. Oceaner uses high modulus graphite materials to build the lightest rod of its type. With a matte black finish and a new hi-tech lightweight handle system, it's good looking as well as functional and gives your outfit a more balanced feel.*



Model	Length	Pc	Line Wt.	Price	Buy-3
CPE-102C	10'	2	2-6	\$59.95	\$54.95
CPE-112C	11'	2	4-8	\$59.95	\$54.95
CPE-122C	12'	2	4-8	\$64.95	\$58.95
SPIN-CPF-143S	14'	3	3-6	\$75.95	\$68.99



## Slab Saber Crappie Trolling Series

*The Slab Saber rods were designed for slow, vertical trolling. Their keen hi-vis yellow tips let you see more bites, while the crappie feels less resistance. The long full butted EVA handle lets you adjust the rod easily. Two styles let you choose the right rod for the reel you prefer (spin or cast).*



Model	Style	Length	Pc.	Price	Buy-3
CSS-102C	CAST	10'	2	\$32.95	\$29.95
CSS-112C	CAST	11'	2	\$33.95	\$30.95
CSS-122C	CAST	12'	2	\$34.95	\$31.95
CSS-102S	SPIN	10'	2	\$32.95	\$29.95
CSS-112S	SPIN	11'	2	\$33.95	\$30.95
CSS-122S	SPIN	12'	2	\$34.95	\$31.95

To Order: 1-800-305-9866



## Panfish Troll Master Series



	Item	Description	Price	Buy-3
•Hi-modulus graphite	PSTM12	12'	\$39.95	\$36.95
•Moderate action	PSTM14	14'	\$42.95	\$38.95
•Stiff for pulling crank baits	PSTM16	16'	\$44.95	\$40.95
•Hi-vis orange tip				
•All are 3 pc. rods				

Tip Section  
for PSTM  
\$18.95

## STARDUST



- High Density Tubular Glass Blank
- Stainless Steel Snake Guides
- Contoured EVA Foam Handle
- Fly Reel Seat

MODEL NO.	LENGTH	PC	HANDLE	BLANK COLOR	LURE WT
SDF-10	10'	2	HYPOLON	GLOSS BLACK	7/8
SDF-9	9'	2	HYPOLON	GLOSS BLACK	7
SDF-86	8'6"	2	HYPOLON	GLOSS BLACK	6/7

Regular Price \$26.95

Closeout Price \$21.95

## Gallatin® Fly Rods Executive 96% Superior Graphite



	Model No.	Length	PC	Handle	Blank Color	Line Wt.	Price
• Thin Diameter, Lightweight 96% Graphite Blank	EXC-702	7'	2	GEN.CORK	DARK BROWN	4/5	\$29.95
• High Speed, Low-Friction Gold Snake Guides	EXC-762	7'6"	2	GEN.CORK	DARK BROWN	4/5	\$31.95
• Contoured Genuine Cork Handle	EXC-802	8'	2	GEN.CORK	DARK BROWN	5	\$33.95
• Deluxe Graphite Reel Seat	EXC-862	8'6"	2	GEN.CORK	DARK BROWN	6	\$35.95
	EXC-902	9'	2	GEN.CORK	DARK BROWN	6/7	\$37.95
	EXC-962	9'6"	2	GEN.CORK	DARK BROWN	6/7	\$39.95

## Gallatin® Onyx Premiere IM-6 Graphite



Model No.	Length	PC	Handle	Line Wt.	Price
OXF-7024	7'	2	CORK	4	\$44.95
OXF-7624	7'6"	2	CORK	4	\$44.95
OXF-8025	8'	2	CORK	5	\$49.95

- Slim Diameter
- Wood Reel Seat
- Cloth Case Included

To Order: [www.grizzlyjig.com](http://www.grizzlyjig.com)



As our stock is depleted, some of our HT Rods will be sold under the FireCast name. Same HT Quality!

## PANFISH SPECIAL

HT's Panfish Special is available in high quality, premium 96% graphite. The Panfish Special features a long handle with a fixed reel seat and is available in 10, 11, 12 foot lengths. with its unique light action blaze orange tip, the Panfish Special will allow you to place even the tiniest micro bait or lure in the hardest to reach locations.



Tip Section  
for PSGT  
\$18.95

Item	Graphite	1 Pole	3 Poles
PSG802	8'	24.95	22.95
PSG102	10'	26.95	24.95
PSG112	11'	29.95	27.95
PSG122	12'	31.95	28.95
PSG-143*	14'	36.95	33.95 *3 PC.
<b>Non-Graphite</b>			
PS802	8'	16.95	15.95
PS102	10'	18.95	17.95
PS112	11'	20.95	18.95
PS122	12'	22.95	20.95
FCP-142-NG	14'	26.95	24.95 oversized

## JIGGIN' STICK

HT's Jiggin' Stik series feature nicely balanced, super light-weight 96% graphite or glass blanks built with all the sensitivity of our panfish style long rods, but with the power necessary to pull out even the largest crappie or bass. Available in 10, 11, 12 foot lengths. The Jiggin' Stik comes with a hi-vis green tip for added visibility.

Tip Section  
for JSGt  
\$18.95



Item	Graphite	1 Pole	3 Poles
JSG102	10'	27.95	25.95
JSG112	11'	29.95	27.95
JSG122	12'	31.95	28.95
<b>Non-Graphite</b>			
JS102	10'	19.95	18.95
JS112	11'	21.95	19.95
JS122	12'	24.95	22.95
Firecast FC142	14'	28.95	26.95 oversized

**Buy 3  
and  
Save**

## SHOOTING STAR TELESCOPIC SERIES w/ Reel Seat & Guides

HT's Shooting Star is designed specifically for trolling enthusiasts. This pole features ceramic shock ring guides, a unique snap-on reel seat, fluorescent yellow tip and textured handle. The snap-on reel seat will accommodate any reel, and the fluorescent yellow tip will improve visibility of the lightest taps. 100% fiberglass. Available in various lengths for proper spider-rigging.



Item	Length	1 Pole	3 Poles
SS-QCS10	10'	10.95	9.95
SS-QCS12	12'	12.95	11.95
SS-QCS14	14'	14.95	13.95
SS-QCS16	16'	18.95	17.95

**Buy 3  
and  
Save**

## SHOOTING STAR TELESCOPIC SERIES w/ Line Winder

HT's Shooting Star Telescopic Poles come in a variety of lengths ranging from 10 foot to 16 foot. All of the rods feature a blaze orange tip for added strike sensing abilities. Comes with or without line winder.



Item	Length	1 Pole	3 Poles
SS-10LW	10'	6.95	5.95
SS-12LW	12'	8.95	7.95
SS-14LW	14'	9.95	8.95
SS-16LW	16'	12.95	11.95
SS-20LW	20'	15.95	14.95

## HI-TECH OR FIRECAST STILLFISH COMBO

*Due to availability.*



Stillfish Combo is a telescopic two and three piece pole with reel. Line through center. Durable fiberglass construction.

Item	Length	1 Pole	3 Poles
SS-10R	10'	12.95	11.95
SS-12R	12'	14.95	13.95
SS-14R	14'	16.95	15.95

**To Order: 1-800-305-9866**

# CRAPPIE COMMANDER GRAPHITE SERIES

Only at Grizzly Jig

The Crappie Commander is the rod that launched the move toward the longer panfish poles in the Midwest. Light graphite construction with thin EVA Tennessee handles. Grizzly Jig has brought the graphite series back by popular demand.

TENNESSEE HANDLE

ULTRA-LITE GRAPHITE



Item	Length	Pc	Price	Buy-3
CCG-10L	10'	2	\$35.95	\$32.95
CCG-11L	11'	2	\$36.95	\$33.95

**Spare Tip**  
\$18.95

## Crappie Commander Pro Troller

Crappie Commander

Graphite

Only at Grizzly Jig

Pro Troller  
w/ Fixed Reel Seat



**Spare Tip**  
\$18.95

Item	Length	Pc	Price	Buy-3	
LCCG-14	14'	2	\$39.95	\$36.95	*Oversized Shipping



## HT Panfish Special Pro



- Cork Handle
- 2 pc Graphite Blank
- Fixed Reel Seat

Model	Length	1 Pole	3 Poles
PSGP-102	10'	38.95	35.95 ea
PSGP-112	11'	41.95	37.95 ea
PSGP-122	12'	43.95	39.95 ea

**Spare Tip**  
\$18.95

Buy 3  
& Save

## HT Shooting Star Top Line Telescopic w/ EVA Foam Handles



- EVA Foam Handle
- Line Guides
- Fixed Reel Seat

Model	Length	1 Pole	3 Poles
SS-10S	10'	13.95	12.95 ea
SS-12S	12'	15.95	14.95 ea
SS-14S	14'	17.95	16.95 ea
SS-16S	16'	19.95	18.95 ea
SS-20S	20'	24.95	22.95 ea

To Order: [www.grizzlyjig.com](http://www.grizzlyjig.com)



This pole features ceramic shock ring guides, a unique snap-on reel seat, fluorescent yellow tip and textured handle. The snap-on reel seat will accommodate any reel, and the fluorescent yellow tip will improve visibility of the lightest taps. 100% fiberglass. Available in various lengths for proper spider-rigging.

**Jimmy Houston Telescopic Shooting Star**



Item	Length	1 Pole	3 Poles
JH-12QCS	12'	14.95	13.95

**Jimmy Houston Xtreme Performance Rods  
IM-6 Graphite Panfish Special**



Item	Length	Action	Pc	Handle	Price	Buy-3
JHPSG-802	8'	Light	2	EVA Foam	\$29.95	\$27.95
JHPSG-102	10'	Light	2	EVA Foam	\$31.95	\$28.95
JHPSG-112	11'	Light	2	EVA Foam	\$33.95	\$30.95
JHPSG-122	12'	Light	2	EVA Foam	\$36.95	\$33.95
JHPSG-143	14'	Light	3	EVA Foam	\$39.95	\$36.95

**Spare Tip**  
\$18.95

**Jimmy Houston Xtreme Performance Pro Rods  
IM-6 Panfish Pro**



Item	Length	Action	Pc	Handle	Price	Buy-3
JHPSGP-102	10'	Light	2	Cork	\$34.95	\$31.95
JHPSGP-112	11'	Light	2	Cork	\$36.95	\$33.95
JHPSGP-122	12'	Light	2	Cork	\$39.95	\$36.95
JHPSGP-143	14'	Light	3	Cork	\$44.95	\$40.95

**Spare Tip**  
\$18.95

**Jimmy Houston Xtreme Performance Pro Rods  
Exclusive Design - Direct to Guide Tech**



Item	Length	Pc	Handle	Price	Buy-3
JHPSGP-102-C	10'	2	Cork	\$49.95	\$45.95
JHPSGP-112-C	11'	2	Cork	\$51.95	\$46.95
JHPSGP-122-C	12'	2	Cork	\$53.95	\$48.95
JHPSGP-143-C	14'	3	Cork	\$59.95	\$54.95



**Polar Fire Reel**  
 •6 BB  
 •Infinite Anti Reverse  
 •Direct to Guide  
 •Thermalube System

**Jimmy Houston Composite Combo**

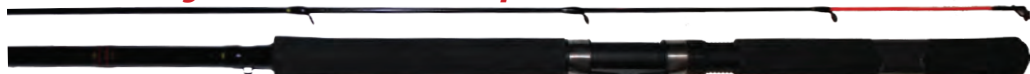

Item	Length	Pc	Handle	Action	Price	Buy-3
JHPS-102-C	10'	2	EVA	Light	\$26.95	\$24.95
JHPS-122-C	12'	2	EVA	Light	\$29.95	\$27.95



**Optimax 101 Reel**  
 •BB Drive  
 •Ratio 5.2:1  
 •310 yds/6#

To Order: 1-800-305-9866



MODEL #	UPC CODE	ACTION	LENGTH	PIECES	LURE WT (oz.)	LINE WT (lb.)	PRICE	BUY-3
E50MLS	894245000709	MicroLite	5'0"	1	1/84 - 1/32	2 - 4	\$54.95	\$49.95
E56ULS	894245000716	UltraLite	5'6"	1	1/64 - 1/16	2 - 4	\$54.95	\$49.95
E60ULS	894245000723	UltraLite	6'0"	1	1/64 - 1/8	2 - 4	\$54.95	\$49.95
E60PLS	894245000730	PowerLite	6'0"	1	1/32 - 3/16	4 - 6	\$54.95	\$49.95
E66ULS	894245000747	UltraLite	6'6"	1	1/32 - 1/8	2 - 6	\$64.95	\$58.95
E66PLS	894245000754	PowerLite	6'6"	1	1/32 - 1/8	4 - 8	\$64.95	\$58.95
E70PLS	894245000761	PowerLite	7'0"	2	1/32 - 3/16	4 - 8	\$64.95	\$58.95
E76MLS	894245000778	MediumLite	7'6"	2	1/32 - 3/16	4 - 8	\$69.95	\$63.95
E80PLS	894245000815	Light	8'0"	2	1/32 - 1/8	4 - 8	\$69.95	\$63.95
E90PJP	894245000785	PowerJig	9'0"	2	1/32 - 3/16	4 - 10	\$69.95	\$63.95
E106PJP	894245000792	PowerJig	10'6"	2	1/32 - 3/16	4 - 10	\$79.95	\$72.95
E12PJP	894245000808	PowerJig	12'0"	2	1/32 - 3/16	4 - 12	\$89.95	\$81.95



### VERTEX™ IM7 GRAPHITE RODS

- IM7 High Modulus Graphite Blank
- Stainless Steel Line Guide Inserts
- Comfortable Cork Handle on Casting & Noodle Rods
- Comfortable Non-Slip EVA Handle on Crappie Actions
- Hook Keeper
- Light Weight Graphite Reel Seat with Cushioned Stainless Steel Hood

Item	Length	Piece	Line Wt. (lb)	Action/Type	Line Wt. (oz)	Guides	Price	Buy-3
VGT802SN	8'0"	2	4-8	Spinning Noodle	1/16-3/8	6+Tip	\$29.95	\$27.95
VGTCR10	10'0"	2	4-10	Med/Crappie Spinning	1/32-1/8	7+Tip	\$29.95	\$27.95
VGTCR12	12'0"	2	4-10	Med/Crappie Spinning	1/32-1/8	8+Tip	\$34.95	\$31.95

### ULTRA BALANCE 6'6" COMBO



#UB662CAM

Combo Price **\$39.95**

#GB100S \$24.99

**Pinnacle Ultra Balance Reel Features:**

- 2 Ball Bearing
- Magnetic Cast Control
- Pre Spooled with 12# Mono
- High Speed Gear Ratio 6.2:1



#UB662 (Rod Only) \$19.99

**Rod Features:**

- Strong Graphite Composite Blank
- Blank Exposed Split Grip for Sensitivity
- Stainless Steel Hooded Reel Seat
- Stainless Steel Guides



To Order: [www.grizzlyjig.com](http://www.grizzlyjig.com)



# Todd HUCKABEE Rods



*A whole new dimension in crappie rods...  
STIFF*



Todd Huckabee signature series crappie rods are designed for vertical jigging and pulling crank baits. These rods are known for great sensitivity and tremendous backbone. Each rod is a 2-piece rod (except the Crappie Ninja, Six Shooter and Dingo) and comes with a 1-year manufacturer's warranty.

**A.**

Model #	Name	Length	PRICE	Buy-3
THSS6ML	Crappie Ninja	5'6"	\$90.00	\$81.00
THS6ML	Six Shooter	6'	\$90.00	\$81.00
THS7M	Dingo	7'	\$105.00	\$95.00

**A.**



**B.**



**C.**



**B.**

Model #	Name	Length	PRICE	Buy-3
THS8M	Prime8	8'	\$105.00	\$95.00
	Tip		\$35.00	-
THS9M	Hot Rod	9'	\$110.00	\$99.00
	Tip		\$40.00	-
THS10M	Dipping	10'	\$105.00	\$95.00
	Tip		\$35.00	-

**C.**

Model #	Name	Length	PRICE	Buy-3
THS10MH	Meat Dragger	10'	\$105.00	\$95.00
	Tip		\$35.00	-
THS106M-S	Elite (Steel Guides)	10'6"	\$110.00	\$99.00
	Tip		\$35.00	-
THS106M-C	Elite (Ceramic Guides)	10'6"	\$110.00	\$99.00
	Tip		\$35.00	-
THS10MHM	Pro Series	10'7"	\$110.00	\$99.00
	Tip		\$40.00	-
THS11M	Pulling	11'	\$105.00	\$95.00
	Tip		\$35.00	-
THS12M	Slab Swinger	12'	\$115.00	\$104.00
	Tip		\$50.00	-
THS13MH	Phanom 13	13'	\$135.00	\$122.00
	Tip		\$60.00	-

To Order: 1-800-305-9866



Wally Marshall™ approved crappie specific actions

**MR. CRAPPIE® Custom RRS**

**A. Mr. Crappie Custom-RRS**

**Graphite Rods**

- Premium high modulus graphite 2-piece blanks
- Lightweight graphite rear reel seat (RRS) for jigging
- Durable 14" EVA foam handle with 2" EVA fightin'-butt
- Stainless steel guides with stainless steel inserts

MODEL	LGTH./PCS.	POWER	PRICE	BUY-3
CGR10-L-2	10'-2	L	\$36.99	\$33.99
CGR9L-2	9'-2	L	\$36.99	\$33.99

**MR. CRAPPIE® Custom Trollers**

**B. Mr. Crappie Custom Troller**

**Graphite Multi-Piece Crappie Rods**

- Premium high modulus graphite multi-piece blanks
- EVA foam handle grips • Lightweight stainless steel guides
- Unique rod length indicator label • Spare tips available
- Lightweight graphite reel seat • Stainless steel hook keepers

MODEL	LGTH./PCS.	POWER	PRICE	BUY-3
CG9L-2	9'-2	L	\$32.99	\$29.95
CG10L-2	10'-2	L	\$33.99	\$30.95
CG12L-2	12'-2	L	\$36.99	\$33.95
CG14L-3	14'-3	L	\$47.95	\$43.95
CG16L-3	16'-3	L	\$57.95	\$52.95

**MR. CRAPPIE® Slab Shaker®**

**C. Mr. Crappie® Slab Shaker®**

**Graphite Rods**

- Premium graphite multi-piece blanks • EVA handle grips
- Stainless steel guides with aluminum oxide inserts
- Graphite reel seat • Stainless steel hook keepers
- Wally Marshall™ approved crappie specific actions
- Spare tips available

MODEL	LGTH./PCS.	POWER	PRICE	BUY-3
MC10PL2G	10'-2	L	\$29.99	\$27.99
MC12PL2G	12'-2	L	\$31.99	\$28.99
MC14PL3G	14'-3	L	\$39.99	\$36.99

**MR. CRAPPIE® Slab Daddy®**

**D. Mr. Crappie® Slab Daddy®**

**Fiberglass Rods**

- Fiberglass 2-piece blanks • EVA foam handle grips
- Graphite reel seat • Stainless steel hook keepers

MODEL	LGTH./PCS.	POWER	PRICE	BUY-3
SD8L-2	8'-2	L	\$22.99	\$20.99
SD9L-2	9'-2	L	\$22.99	\$20.99
SD10L-2	10'-2	L	\$22.99	\$20.00
SD12L-2	12'-2	L	\$27.99	\$25.99
SD14L-12	14'-2	L	\$27.99	\$25.99

**MR. CRAPPIE® Slab Shaker®**

**E.-F. Mr. Crappie® Slab Shaker®**

**Casting & Spinning Rods**

- 2-piece fiberglass construction
- Stainless steel guides with stainless steel inserts
- Durable EVA foam grips on casting models
- Split-grip EVA handles on spinning models
- Lightweight graphite reel seats

MODEL	LGTH./PCS.	POWER	PRICE	BUY-3
<b>E. CASTING</b>				
MCC56-2	5'6"-2	L	\$11.99	\$10.99
<b>F. SPINNING</b>				
MCS46-2	4'6"-2	L	\$ 9.99	\$ 8.99
MCS56-2	5'6"-2	L	\$11.99	\$10.99
MCS60-2	6'0"-2	L	\$12.99	\$11.99
MCS66-2	6'6"-2	L	\$14.99	\$13.99

**G. Wally Marshall Speed Stick Rods**

- Premium IM6 one-piece graphite blanks with technique specific action
- Stainless steel frame with aluminum oxide inserts
- Graphite reel seat • High density EVA cushioned handles
- Professional style hook keepers

MODEL	POWER	LGTH.	PRICE	BUY-3
WMSS80-2	ML	8'0"	\$49.99	\$45.99
WMSS90-2	ML	9'0"	\$49.99	\$45.99
WMSS10-2	ML	10'0"	\$49.99	\$45.00
WMSS11-2	ML	11'0"	\$54.99	\$49.99
WMSS12-2	ML	12'0"	\$57.99	\$52.99
WMSS14-2	ML	14'0"	\$59.99	\$54.99

Feel every thump with these awesome rods! Great for all crappie fishing techniques.

Wally Marshall™  
SIGNATURE SERIES

RODS



Wally Marshall Pro series crappie rods are designed for standing timber and heavy brush! Super light weight, fast tip and plenty of backbone to sling a big slab in the boat!

PRO SERIES TROLL TECH SIGNATURE SERIES



Wally Marshall™

PRO SERIES IM 8

Wally Marshall Pro Series Rods

- Premium IM8 graphite blanks
- Stainless steel spinning guides with stainless steel inserts
- Lightweight graphite spinning reel seats
- Premium oversized cork handles with Duracork accents
- Stainless steel hook keeper
- Wally Marshall approved actions

MODEL	LGTH. /PCS.	POWER	TIP ACTION	LINE RATING (LB.)	GUIDES +TIP	PRICE	BUY-3
WMPSS56ML*	5'6"-1	ML	M	2-8	8+TIP	\$39.99	\$36.99
WMPSS60ML*	6'0"-1	ML	M	2-8	8+TIP	\$44.99	\$40.99
WMPSS66ML*	6'6"-1	ML	M	2-8	9+TIP	\$44.99	\$40.99
WMPSS70ML*	7'0"-1	ML	M	2-8	9+TIP	\$49.99	\$45.99
WMPSR80ML	8'0"-2	ML	M	4-10	10+TIP	\$49.99	\$45.99
WMPSR90ML	9'0"-2	ML	M	4-10	10+TIP	\$54.99	\$49.99
WMPSR10ML	10'0"-2	ML	M	4-10	12+TIP	\$59.99	\$54.99
WMPSR11ML	11'0"-2	ML	M	4-10	12+TIP	\$59.99	\$54.99
WMPSR12ML	12'0"-2	ML	M	4-10	13+TIP	\$64.99	\$58.99
WMPSR10ML-RS	10'0"-2	ML	M	4-10	12+TIP	\$59.99	\$54.99
WMPSR11ML-RS	11'0"-2	ML	M	4-10	12+TIP	\$59.99	\$54.99

NEW

\*Split-grip cork handles with Duracork accents.



Wally Marshall™

TROLL-TECH IM 6

Wally Marshall Troll Tech Power Trolling Crappie Rods

- Premium IM6 graphite blanks
- Lightweight graphite reel seat with metal hoods
- Comfortable EVA grips
- Hard aluminum oxide guide inserts
- Ideal for tightline trolling, drifting, and spider rigging
- Wally Marshall approved actions
- Unique rod length indicator label
- Spare tips available
- Stainless steel hook keepers
- Good for pushing and pulling crankbaits

MODEL	LGTH. /PCS.	POWER	TIP ACTION	LINE RATING	GUIDES +TIP	PRICE	BUY-3
WMT10-2	10'-2	MH	M	1	12+TIP	\$46.99	\$42.99
WMT12-2	12'-2	MH	M	10-25	13+TIP	\$56.99	\$51.99
WMT14-3	14'-3	MH	M	10-25	14+TIP	\$64.99	\$58.99
WMT16-3	16'-3	MH	M	10-25	15+TIP	\$69.99	\$63.99



Wally Marshall™

SIGNATURE SERIES IM 6

NEW Wally Marshall Signature Series Crappie Rods

- Premium IM6 graphite blanks
- Lightweight graphite reel seat with metal hoods
- Comfortable EVA grips
- Wally Marshall approved actions
- Unique rod length indicator label
- Hard aluminum oxide guide inserts
- Spare tips available
- Stainless steel hook keepers
- Designed for vertical jigging, tight line trolling, and pulling cranks

MODEL	LGTH. /PCS.	POWER	TIP ACTION	LINE RATING (LB.)	GUIDES +TIP	PRICE	BUY-3
WMSO70L	7'-1	L	F	2-10	9+TIP	\$49.99	\$46.99
WMSO80-2	8'-2	ML	M	4-12	11+TIP	\$49.99	\$46.99
WMSO90-2	9'-2	ML	M	4-12	12+TIP	\$49.99	\$46.99
WMSO10-2	10'-2	ML	M	4-12	12+TIP	\$49.99	\$46.99
WMSO12-2	12'-2	ML	M	4-12	13+TIP	\$56.99	\$51.99
WMSO14-3	14'-3	ML	M	4-12	14+TIP	\$56.99	\$51.99
WMSO16-3	16'-3	ML	M	4-12	16+TIP	\$59.99	\$54.99

To Order: 1-800-305-9866

### Mr. Crappie® Slab Daddy® Crappie Jiggin' Combos

**Reel Features:**

- Dual bearing system
- Lightweight Polycarbonate frame and spool
- Adjustable star drag
- Line Capacity: 110yd./6lb.
- Gear Ratio: 1:1
- Pre-spooled with Mr. Crappie premium 6lb. Hi-Vis mono

**Rod Features:**

- 2-piece fiberglass construction
- Stainless steel guides with aluminum oxide inserts
- Durable lightweight EVA foam grips
- Unique rod length indicator
- Stainless steel hook keepers
- Graphite reel seat with aluminum hoods

**MR. CRAPPIE® Slab Daddy®**



COMBO MODEL	REEL MODEL	LGTH. /PCS.	POWER	PRICE	BUY-3
SDJ8-2	MC1	8'-2	L	\$24.99	\$22.99
SDJ9-2	MC1	9'-2	L	\$26.99	\$24.99
SDJ10-2	MC1	10'-2	L	\$25.99	\$23.99
SDJ12-2	MC1	12'-2	L	\$26.99	\$24.99
SDJ14-2	MC1	14'-2	L	\$29.99	\$27.99

### Mr. Crappie Slab Daddy Solo Crappie Combos

**Reel Features:**

- 2-bearing System
- Strong and lightweight graphite frame and spool
- Extended reel foot stem for improved handling
- Wide range, multi-disc drag with click function
- Large arbor design reduces line twist and increases line recovery
- Pre-spooled with Mr. Crappie premium 6lb. Hi-Vis mono

**MR. CRAPPIE® Slab Daddy® Sol**

**Rod Features:**

- Light action fiberglass construction blanks
- Lightweight graphite reel seats with aluminum hoods
- Stainless steel guides with aluminum oxide inserts
- Durable lightweight EVA foam grips
- Stainless steel hook keepers

COMBO MODEL	REEL MODEL	LGTH. /PCS.	POWER	PRICE	BUY-3
SST9-2	SO1	9'-2	L	\$32.99	\$29.99
SST10-2	SO1	10'-2	L	\$34.99	\$31.99
SST12-2	SO1	12'-2	L	\$39.99	\$36.99

### Mr. Crappie® Slab Daddy® Jig/Troll Crappie Combos

**Reel Features:**

- Strong, plated metal frame
- Anti-reverse lever
- Audible bait clicker/Spool tension adjustment control
- Line cap. 90yd./6lb. mono
- Pre-spooled with premium Mr. Crappie 6 lb. mono

**Rod Features:**

- 2-piece blank light action fiberglass construction
- Lightweight graphite reel seats with aluminum hoods
- Stainless steel hook keepers
- Durable lightweight EVA foam grips

**MR. CRAPPIE® Slab Daddy®**

COMBO MODEL	LGTH. /PCS.	GEAR RATIO	POWER	PRICE	BUY-3
SDC10-2	10'-2	3.6:1	L	\$31.99	\$28.95
SDC12-2	12'-2	3.6:1	L	\$36.99	\$33.95



*Without Air Guides*

### Wally Marshall Speed Shooter Combos

**Reel Features:**

- Lightweight graphite body and skeletal rotor design
- Quality 4-bearing system with Zero Reverse® one-way clutch bearing
- Double anodized ported aluminum spool
- Strong and balanced aluminum bail
- Thin compact gear box
- Collapsible handle adjusts for left/right hand retrieve



**Rod Features:**

- Premium IM6 one-piece graphite blanks with technique specific action
- **Stainless steel guides with stainless steel inserts**
- Lew's exclusive lightweight graphite skeletal reel seat
- High density EVA cushioned split grip handles
- Professional style hook keepers

### Wally Marshall Speed Shooter Rods

**Features:** Premium IM6 one-piece graphite blanks with technique specific action  
 • American Tackle MicroWave™ Air Guide system  
 • Lew's exclusive lightweight graphite skeletal reel seat  
 • High density EVA cushioned split grip handles  
 • Professional style hook keepers



MODEL	POWER	TIP ACTION	LGTH. /PCS.	RATING	LINE RATING	LURE RATING	GUIDES + TIP	PRICE	BUY-3
WMSS56ML	ML	F	5'6"-1	4-10	1/16-1/4	6+TIP	\$42.99	\$38.95	
WMSS60ML	ML	F	6'0"-1	4-10	1/16-1/4	6+TIP	\$42.99	\$38.95	
WMSS66ML	ML	F	6'6"-1	4-10	1/16-1/4	6+TIP	\$42.99	\$38.95	
WMSS70ML	ML	F	7'0"-1	4-10	1/16-1/4	7+TIP	\$46.99	\$42.99	

### WMSS 100 Reel

COMBO MODEL	LGTH. /PCS.	POWER	REEL WT. (OZ.)	LINE CAP. (YD./LB.)	GEAR RATIO RPT*	PRICE
WMSS10060ML	6'0"-1	ML	7.8	160/6	5.1:1 23.5	\$59.99
WMSS10066ML	6'6"-1	ML	7.8	160/6	5.1:1 23.5	\$59.99

\*Recovery Per Turn.

*With Air Guides*

### Wally Marshall Speed Shooter Combo

A Grizzly Jig Exclusive



MODEL	LENGTH	REEL	PRICE
WMSS7556ML-AIR	5'6"	75	\$69.99
WMSS10060ML-AIR	6'	100	\$69.99
WMSS10066ML-AIR	6'6"	100	\$69.99
WMSS10070ML-AIR	7'	100	\$74.95

Our #1 Selling Dock Shooter

To Order: [www.grizzlyjig.com](http://www.grizzlyjig.com)



**EXPERIENCE THE DIFFERENCE**

Denali's lineup of rods combines the best of old-world craftsmanship and state of the art technologies to bring today's anglers rods that are feather-light, extremely sensitive and remarkably durable. Whether in tournament conditions or everyday fishing, Denali's lineup has you covered.

**PRYME SERIES**



Product Name	Part #	Handle	Pc	Price	Buy-3
7'6" Spinning Rod	P901SR	EVA	1	\$54.99	\$49.99
7' Dock Rod	P841DR	EVA	1	\$54.99	\$49.99
6'6" Spinning Rod	P781SR	EVA	1	\$54.99	\$49.99
6' Dock Rod	P721DR	EVA	1	\$45.99	\$41.99
4'6" Spinning Rod	P541SR	EVA	1	\$45.99	\$41.99

**PRYME JIGGING/TROLLING RODS**



Product Name	Part #	Handle	Pc	Price	Buy-3
10' Light Jigging Rod	P1201LJ	EVA	2	\$64.99	\$58.99
10' Heavy Jigging Rod	P1201HJ	EVA	2	\$64.99	\$58.99
12' Heavy Jigging Rod	P1441HJ	EVA	2	\$69.95	\$63.99
12' Trolling Rod	P1441TR	EVA	2	\$76.99	\$68.99
14' Trolling Rod	P1681TR	EVA	3	\$79.99	\$72.99
16' Trolling Rod	P1921TR	EVA	3	\$82.99	\$74.99
18' Trolling Rod	P2161TR	EVA	3	\$85.99	\$77.99

**Spare Tips**  
**\$19.95**



**Crappie Hunter Rods**

- IM-6 Graphite Blank
- EVA Foam Handles
- Crappie Bluegill Action
- Orange Hi-Vis Tip

Model	Length
CHSP902	9'
CHSP102	10'
CHSP122	12'



**Your Choice**  
**\$29.95**  
**Special Buy-3**  
**\$26.95**



**C-Series Crappie Pro**



	Model	Length	Rod Action	Price	Buy-3
•24 Ton Carbon Fiber Blank	BCS1002L	10'	M/F	\$36.99	\$33.99
•Solid Carbon Fiber Hi-Vis Tip	BCS1202L	12'	M/F	\$38.99	\$35.99
•Titanium Oxide Guides	BCS1403L	14'	M/F	\$41.99	\$37.99
•EVA Power Grip Handle					
•Fixed Reel Seat					

To Order: 1-800-305-9866

# CATFISH RODS



Model	Length	Action	Style	Price	Buy-3
BF904BR	7'6"	Heavy	Bumping	\$99.99	\$90.99
BF905BR	7'6"	X-Heavy	Bumping	\$99.99	\$90.99
BF902S	7'6"	Medium	Spinning	\$44.99	\$40.99
BF903S	7'6"	Med-Heavy	Spinning	\$44.99	\$40.99
BF902C	7'6"	Medium	Cast	\$44.99	\$40.99
BF903C	7'6"	Med-Heavy	Cast	\$44.99	\$40.99
BF964C	8'	Heavy	Cast	\$44.99	\$40.99
BF964S	8'	Heavy	Spinning	\$44.99	\$40.99

## kingHawk<sup>®</sup> HYPER GLOW SERIES E-Glass Catfish Rods



Tip, Guides, and All Wrapping Glow in the Dark

Model	Length	Handle	Line Wt.	Pieces	Lure Wt.	Action	Price
HG825SPIN	8'	Cork	15-30#	2	1-3 oz.	M	\$29.95
HG827CAST	8'	Cork	15-30#	2	1-3 oz.	MH	\$29.95
HG1227SPIN	12'	Cork	20-40#	2	3-5 oz.	MH	\$38.95



### Cat Daddy Combos



Item	Length	Reel Sz	Ratio	Price
CD7050MH	7'	50	4.7:1	\$36.99
CD7090MH	9'	70	5.1:1	\$39.99
CD7010MH	10' (white)	70	5.1:1	\$44.99

- |                          |                                       |
|--------------------------|---------------------------------------|
| <b>ROD</b>               | <b>REEL</b>                           |
| •2 pc Glass Blank        | •3 Ball Bearing                       |
| •EVA Split Grip Handle   | •Multi Stop Anti Reverse              |
| •Double Footed SS Guides | •Aluminum Spool                       |
| •Heavy Duty Hook Keeper  | •Filled with 15#-20# Mr. Catfish Line |

## HYPER CAT SERIES E-Glass Monster Catfish Rods

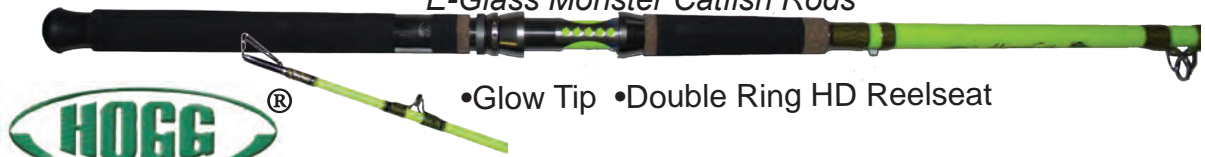

- Glow Tip
- Double Ring HD Reel seat

Model	Length	Handle	Line Wt.	Pieces	Lure Wt.	Action	Guide	Price
HC-761MH-CAST	7'6"	EVA/Cork	15-40#	1	2-5 oz.	MH-FAST	10+Tip	\$69.95
HC-761MS-SPIN	7'6"	EVA/Cork	15-40#	1	2-5 oz.	HH-FAST	8+Tip	\$69.95
<b>HYPER CAT JR. WITH STANDARD REEL SEAT</b>								
HCJ-701MS-SPIN	7'	EVA/Cork	15-40#	1	2-5 oz.	MH-FAST	7+Tip	\$49.95

To Order: [www.grizzlyjig.com](http://www.grizzlyjig.com)

# BIG CAT FEVER RODS



- S-Glass Blank Through Construction
- Double Locking Solid Aluminum Reel Seat
- Oversized Stainless Hook Keeper
- Solid Stainless Guides

MODEL	LENGTH	COLOR	STYLE	ACTION	HANDLE	PRICE	BUY-3
BCF-BM-FC	7'6"	Black	Cast	Med	Foam	84.95	76.95
BCF-BM-CC	7'6"	Black	Cast	Med	Cork	79.95	72.95
BCF-BMH-FC	7'6"	Black	Cast	Med-Heavy	Foam	84.95	76.95
BCF-BMH-CC	7'6"	Black	Cast	Med-Heavy	Cork	79.95	72.95
BCF-BH-FC	7'6"	Black	Cast	Heavy	Foam	89.95	81.95
BCF-BH-CC	7'6"	Black	Cast	Heavy	Cork	84.95	76.95
BCF-WM-FS	7'6"	White	Spin	Medium	Foam	84.95	76.95
BCF-WM-CS	7'6"	White	Spin	Medium	Cork	79.95	72.95
BCF-WMH-FS	7'6"	White	Spin	Med-Heavy	Foam	84.95	76.95
BCF-WMH-CS	7'6"	White	Spin	Med-Heavy	Cork	79.95	72.95
BCF-BM-FS	7'6"	Black	Spin	Medium	Foam	84.95	76.95
BCF-BM-CS	7'6"	Black	Spin	Medium	Cork	79.95	72.95
BCF-BMH-FS	7'6"	Black	Spin	Med-Heavy	Foam	84.95	76.92
BCF-BMH-CS	7'6"	Black	Spin	Med-Heavy	Cork	79.95	72.95

*Be sure and check out our selection of Catch the Fever Slime Line!!*



Scenes from one of many cattfish tournaments held on the Mississippi River in Caruthersville. Check out our Facebook page for local tournament info!

To Order: 1-800-305-9866

# HT CATFISH RODS

## OL' WHISKERS CATFISH SYSTEM

Six Inch Phosphorescent Glow Tip



	MODEL NO.	LENGTH	PC	ACTION	HANDLE	BLANK COLOR	LINE TEST	LURE WT	PRICE
• Premium Tubular Glass Blank	OWS-702MH	7'	2	MED/HEAVY	SPINNING	WHITE	10# - 17#	1/4-3/4 oz	\$18.95
• Blank-Thru Construction	OWS-802MH	8'	2	MED/HEAVY	SPINNING	WHITE	10# - 17#	1/4-3/4 oz	\$19.95
• Super Strong Chrome Guides	OWS-902MH	9'	2	MED/HEAVY	SPINNING	WHITE	12# - 25#	1/4-7/8 oz	\$21.95
• EVA Foam Grip Handle	OWS-102MH	10'	2	MED/HEAVY	SPINNING	WHITE	15# - 27#	1/4-1 oz	\$23.95
• 6" Phosphorescent Glow Tip	OWS-112MH	11'	2	MED/HEAVY	SPINNING	WHITE	17# - 30#	1/4-1 1/4 oz	\$25.95
• Sure-Lock Reel Seat	OWS-122MH	12'	2	MED/HEAVY	SPINNING	WHITE	17# - 35#	1/4-1 1/2 oz	\$27.95
	OWS-132MH	13'	2	MED/HEAVY	SPINNING	WHITE	17# - 40#	1/2-1 3/4 oz	\$29.95
	OWS-153MH	15'	3	MED/HEAVY	SPINNING	WHITE	17# - 40#	1/2-2 oz	\$31.95
<b>CASTING RODS</b>									
	OWS-702T	7'	2	MED/HEAVY	TRIGGER	WHITE	10# - 17#	1/4-3/4 oz	\$19.95
	OWS-802T	8'	2	MED/HEAVY	TRIGGER	WHITE	15# - 25#	1/4-3/4 oz	\$20.95
	OWS-902T	9'	2	MED/HEAVY	TRIGGER	WHITE	15# - 25#	1/4-3/4 oz	\$22.95
	OWS-102T	10'	2	MED/HEAVY	TRIGGER	WHITE	15# - 25#	1/4-3/4 oz	\$24.95

## Ol' Whiskers Glow Stick



<ul style="list-style-type: none"> <li>• Graphite Composite Blank</li> <li>• Super Strong Chrome Guides</li> <li>• EVA Foam Grip Handle</li> <li>• 6" Phosphorescent Glow Tip</li> <li>• Sure-Lock Reel Seat</li> <li>• 2 pc</li> </ul>	<table style="width: 100%;"> <thead> <tr> <th style="text-align: left;">Item</th> <th style="text-align: left;">Length</th> <th style="text-align: left;">Price</th> </tr> </thead> <tbody> <tr> <td>OWGS802</td> <td>8'</td> <td>\$18.99</td> </tr> <tr> <td>OWGS902</td> <td>9'</td> <td>\$21.99</td> </tr> <tr> <td>OWGS1002</td> <td>10'</td> <td>\$26.99</td> </tr> <tr> <td>OWGS1202</td> <td>12'</td> <td>\$32.99</td> </tr> </tbody> </table>	Item	Length	Price	OWGS802	8'	\$18.99	OWGS902	9'	\$21.99	OWGS1002	10'	\$26.99	OWGS1202	12'	\$32.99	
Item	Length	Price															
OWGS802	8'	\$18.99															
OWGS902	9'	\$21.99															
OWGS1002	10'	\$26.99															
OWGS1202	12'	\$32.99															

## Ole' Yeller Series



\$25.<sup>95</sup>

Catfish Rod			
OYS-10	10'	2 pc.	Med/Heavy Action Line Wt. 10-25#
OYS-11	11'	2 pc.	Med/Heavy Action Line Wt. 10-25#
OYS-12	12'	2 pc.	Med/Heavy Action Line Wt. 10-25#
OYS-9	9'	2 pc.	Med/Heavy Action Line Wt. 10-25#
OYS-8	8'	2 pc.	Med/Heavy Action Line Wt. 10-25#
OYS-7	7'	2 pc.	Med/Heavy Action Line Wt. 10-25#

Reg. Price  
\$29.95

\$18.<sup>95</sup>

## MAGNUM POWER

### Heavy Action Catfish Rod

MP-701 7' 1 pc. Glass Blank Lure Wt. 6 oz.



To Order: [www.grizzlyjig.com](http://www.grizzlyjig.com)





## Big T Trick Stick



Model #	Length	Pc	Action	Guides & Tip	Price
70SMMF	7'	1	Med/Mod Fast	8+TIP	\$110.99

- Heavy Backbone
- Light Sensitive Tip
- Line Depth Guides
- High Visibility Tip



## SPIDER TROLL - TROLLING ROD

Model #	Length	Pcs	Action	Guides + Tip	Price	Buy-3
ST1202	12'	2	Heavy Back Bone/ Light Tip	12+Tip	\$44.95	\$40.95
ST1403	14'	3	Heavy Back Bone/ Light Tip	13+Tip	\$49.95	\$45.95
ST1603	16'	3	Heavy Back Bone/ Light Tip	14+Tip	\$59.95	\$54.95

SPARE TIPS \$19.95

## Slab City - Trolling Rod



Model #	Length	Pc	Action	Guides & Tip	Price	Buy 3
SC1002G	10'	2	Medium	8+TIP	\$32.99	\$29.99
SC1202G	12'	2	Medium	8+TIP	\$38.99	\$35.99
SC1404G	14'	3	Medium	11+TIP	\$47.99	\$43.99
SC1603G	16'	3	Medium	12+TIP	\$52.99	\$47.99

SPARE TIPS \$19.95



## HyperSense 10 - Jigging Rod

- Extreme Sensitivity
- Cork Handle
- Light weight

Model #	Length	Pcs	Action	Guides + Tip	Price	Buy-3
JHS102	10'	2	Fast w/ Light Tip	10+Tip	\$48.99	\$44.99 Spare Tip \$19.95
JHS1102	11'	2	Fast w/ Light Tip	11+Tip	\$49.99	\$45.99 Spare Tip \$19.95
JHS6001	6'	1	Fast w/ Light Tip	6+Tip	\$39.99	\$36.99
JHS7001	7'	1	Fast w/ Light Tip	7+Tip	\$39.99	\$36.99
NEW JHS7001ML	7'	1	Med w/ Light Tip	9+Tip	\$47.99	\$43.99
NEW JHSM6001	6'	1	XFast w/ Light Tip	6+Tip	\$68.99	\$62.99

## Cypress Creek Glass Composite



Model #	Length	Pc	Action	Price	Buy 3
CCCR802	8'	2	Medium	\$23.99	\$21.99
CCCR1002	10'	2	Medium	\$25.99	\$23.99
CCCR1202	12'	2	Medium	\$28.99	\$26.99
CCCR1402	14'	2	Medium	\$29.99	\$27.99

- Blends quality and affordability
  - Composite
  - Ceramic guides
  - Hi-vis tip
- SPARE TIPS N/A

## Kevin Rogers Jigging Rod



Model #	Length	Pc	Action	Price	Buy 3
KR1002JR	10'	2	Medium	\$58.95	\$53.95
KR1102JR Rear Seat	11'	2	Medium	\$58.95	\$53.95
NEW KR1102M	11'	2	Medium	\$58.95	\$53.95

- Graphite blank
  - Ultra-thin EVA grip
  - Stainless steel micro-guides
- SPARE TIPS \$19.95

To Order: 1-800-305-9866



WATER EAGLE™ GRAPHITE COMPOSITE FLY ROD  
**EAGLE CLAW®**

WATER EAGLE™



WE-100

CASTING ROD



Fly Model	Type	Price	Length	Sections	Action	Line
WE300-86	Fly	\$19.95	8'6"	2	P	7/8
WE200-66	Spin	\$14.95	6'6"	2	M	4-12
WE200-7	Spin	\$14.95	7'	2	M	4-12
Pistol Grip BRV100-5	Cast	\$12.95	5'	2	M	4-15

**Featherlight Series**



Traditional Glass w/  
Ultra Light Action.

Model	Price	Length	Sections	Action	Line
FL-300-7	\$27.95	7'	2	Parabolic	5/6
FL-300-8	\$27.95	8'	2	Parabolic	5/6
FL-204-6	\$25.95	6'	2	Parabolic	2/6
FL-204-6'6"	\$25.95	6'6"	2	Parabolic	2/6

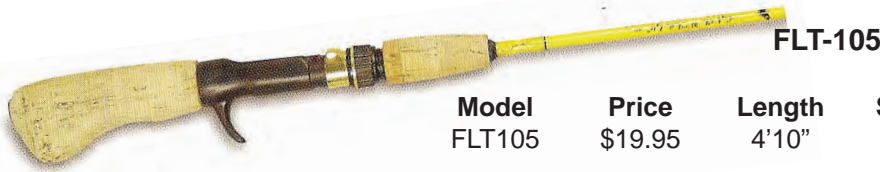

FLT-105

Model	Price	Length	Sections	Action	Line
FLT105	\$19.95	4'10"	2	UL	2-6#



**Featherlight Crappie**

FL-209

Model	Price	Length	Sections	Action	Line
FL209-7'6"	\$27.95	7'6"	2	ML	4-8#
FL209-9"	\$29.95	9'	2	ML	4-8#



**EAGLE CLAW®**

Special Buy

**Gold Diamond - IM6 Graphite**

Crappie Spinning



Cork

\$21.<sup>95</sup>

#BDL6-52 Light Action 6' 2 Pc Line 4-8# Lure Wt. 1/16-1/4 oz.

Reg. MAP Price  
\$36.95



**Fishing Butler**

The Ultimate in Fishing Rod Ties

Small	Single Pole	#FB-1	\$2.99	•Floats
Medium	Multi Pole	#FB-2	\$3.99	•Quick Release
Large	Bundle	#FB-3	\$4.99	•Adjustable
				•Locking

To Order: [www.grizzlyjig.com](http://www.grizzlyjig.com)

# Firecast

## Big Eye Series



### Carolina Style Flipping Sticks

Model	Length	Sections	1 Pole	Buy-3
#FBE76	7 1/2'	2 pc.	\$32.95	\$29.95
#FBE10	10'	2 pc.	\$36.95	\$33.95

Replacement Tips \$17.95



Gray/Burgundy Wrap -- Light Action -- Graphite -- Cork Handle

Flo-Orange Tip

### Pro Series Graphite

•98% Graphite Blank •EVA Foam Handle •Fixed Reel Seat



Model	Pc	Length	Handle	Price	Buy-3
FCP102	2	10'	EVA	\$34.95	\$31.95
FCP122	2	12'	EVA	\$41.95	\$37.95
*FCP142	2	14'	EVA	\$44.95	\$40.95

Replacement Tips \$17.95

\*Note: FC142 and FCP142 will ship in an oversize tube. Add \$8.00 extra shipping per tube. One tube will hold 1-5 rods.

Flo-Orange Tip

### Promotional Glass Series

•98% Graphite Blank •EVA Foam Handle •Fixed Reel Seat



Model	Pc	Length	Handle	Price	Buy-3
FC102	2	10'	EVA	\$19.99	\$18.99
FC112	2	11'	EVA	\$21.99	\$19.99
FC122	2	12'	EVA	\$24.99	\$22.99
*FC142	2	14'	EVA	\$29.99	\$27.99

\*Note: FC142 and FCP142 will ship in an oversize tube. Add \$8.00 extra shipping per tube. One tube will hold 1-5 rods.

FC142 is green!

### Promotional Glass Series

Model	Pc	Length	Line Wt	Price	Buy-3
FCF-7	2	7'	6	\$16.99	\$15.99
FCF-9	2	9'	7	\$19.99	\$18.99
FCF-10	2	10'	7/8	\$21.99	\$19.99



To Order: 1-800-305-9866

# GRIZCO Rod Tips

*Introducing our new line of tip sections*

**GRIZCO** Tips range from **\$17.<sup>95</sup> - \$21.<sup>95</sup>**

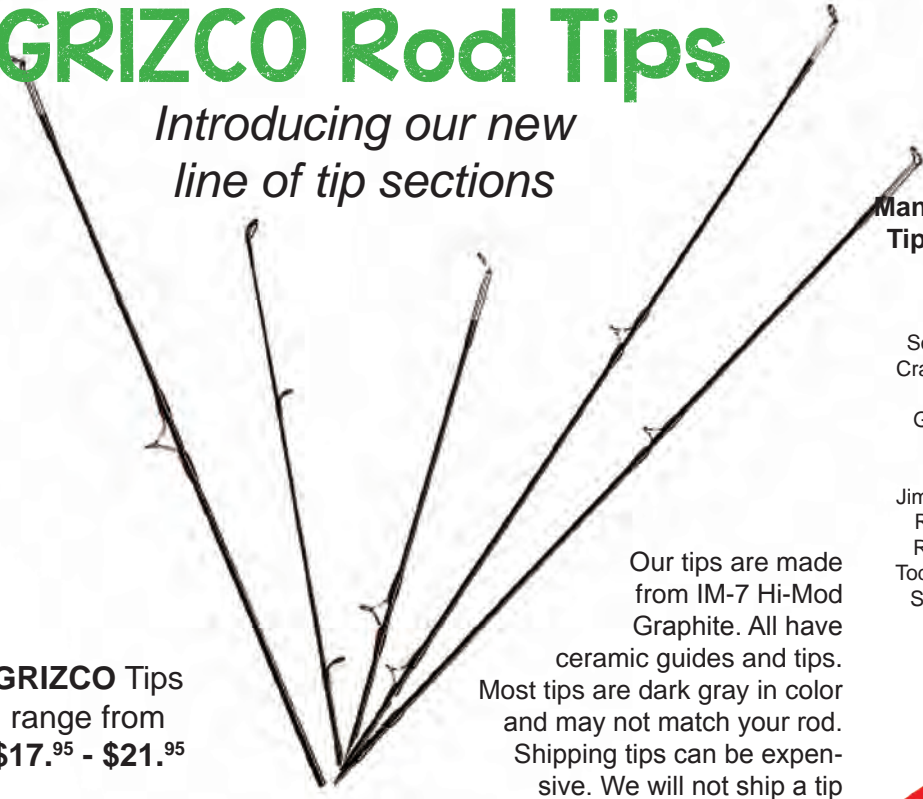

Our tips are made from IM-7 Hi-Mod Graphite. All have ceramic guides and tips. Most tips are dark gray in color and may not match your rod. Shipping tips can be expensive. We will not ship a tip unless we make sure it will fit. We will need the rod model number and length.

*We, at Grizzly, try to carry manufacturer's tips for all the rods we sell, but some are not available.*

**Manufacturer's Tips In Stock**

- B'nM
- Outlaw
- Ozark
- Southern Pro
- Crappie Wizard
- Lexus
- Grizzly Elite
- Hi-Tech
- Firecast
- Jimmy Houston
- Roger Gant
- Russ Bailey
- Todd Huckabee
- Sam Heaton
- Jenko

**GRIZCO Replacement Tips**

- St. Clair Gold
- Golden Falcon
- Wally Marshall
- Mr. Crappie
- Hi-Tech
- Crappie-Stik
- Crappie Wizard
- Ozark
- Outlaw
- Bert Bennett
- Luxor
- American Spirit
- Crappie Commander
- Denali
- and More



*Grizzly Jig goes one step beyond the competition.*

*We are now selling replacement butt sections for your favorite rod.*

*Save \$15-\$30 off the price of a new pole.*

**HOW TO ORDER:**

- Step 1:** Go through our catalog and find your rod.
- Step 2:** Check to see if we show an exact replacement tip for that rod.
- Step 3:** Subtract the tip price from the rod and that will be your cost.
- Step 4:** If no replacement tip is shown, call us for a quote.

**1-800-305-9866**

**To Order: [www.grizzlyjig.com](http://www.grizzlyjig.com)**





# Zebco Combos

## OMEGA PRO

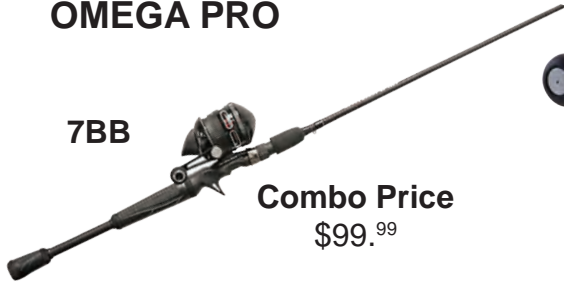

7BB

Combo Price  
\$99.<sup>99</sup>

MODEL	ROD	ACTION	PC
ZO3PRO662M	6'6"	M	2

## OMEGA

ZO2  
ZO3



7BB

Combo Price  
\$79.<sup>99</sup>

MODEL	ROD	ACTION	PC
ZO2C	5'6"	ML	2
ZO3C	6'	M	2

## DELTA

ZD2  
ZD3



5BB

Combo Price  
\$54.<sup>99</sup>

MODEL	ROD	ACTION	PC
ZD2C	5'6"	ML	2
ZD3C	6'	M	2

## 33 PLATINUM

5BB



Combo Price  
\$49.<sup>99</sup>

MODEL	ROD	ACTION	PC
33PL602M	6'	M	2

## 33 MAX GOLD



3BB

20 LB LINE

Combo Price  
\$39.<sup>99</sup>

MODEL	ROD	ACTION	PC
33MAXGLD2MH	6'6"	MH	2

## ZEBCO ECONOMY COMBOS\*



MODEL	ROD	ACTION	LINE WT	PC	PRICE
101C	5'	ML	6#	2	\$12.99
202C	5'6"	M	10#	2	\$14.99
404C	6'	M	15#	2	\$18.99
606C	6'6"	MH	20#	2	\$26.99
808C	7'	MH	20#	2	\$34.99

\*Reel Colors May Vary

**CLOSEOUT**  
1- STANDARD 33 COMBO  
**AND**  
1-LADIES 33 COMBO



2 Each Zebco 5'6" .... 1 His, 1 Hers Medium Action  
2 Each Zebco 33 Reel .... 1 Standard, 1 Lady's  
Both spooled with 10# Cajun Red Line

#HIS-HERS  
\$39.95

# QUANTUM®

## KVD 6'9" COMBO

**\$79.99**

#KVDC695FC



- Reel:
- 8 Ball Bearing
  - Continuous Anti-Reverse
  - Aluminum Spool
  - High Speed 7.3:1

- Rod:
- 6'9", 1 PC Medium/Heavy Graphite Blank
  - Split Handle
  - Direct to Blank Touch
  - Aluminum Oxide Guides
  - Line Wt. 8-14#

## TETON TROUT COMBO



Graphite•Cork Handle•Solid Graphite Tip

Although this rod was designed for trout, it is one of our most popular crappie rods.

MODEL	LENGTH	ACTION	LINE WT	PC	PRICE
TLS662LC	6'6"	L	2-6#	2	\$39.95

## XTRALITE

**NEW**

Quantum Xtralite Rods feature the MicroTrack™ guide system to reduce weight and deliver greater control.



MODEL	LENGTH	PC	POWER	ACTION	LINE WT	LURE WT
XTS461ULB	4'6"	1	UL	FAST	2-6#	1/64-1/8
XTS501ULB	5'	1	UL	FAST	2-6#	1/64-1/8
XTS662ULB	6'6"	1	UL	FAST	2-6#	1/64-1/8
XTS701ULB	7'	2	UL	FAST	4-8#	1/32-3/16

**Your Choice**  
**\$29.95**

## TELECAST

Quantum Telecast Rods are designed for easy stowing and transport. Graphite Telescopic Blank



MODEL	ACTION	SECTIONS	TYPE	LINE WT	LURE WT
QXTELC605M	M/L	5	CAST	4-8#	1/16-3/8
QXTELS505UL	UL	5	SPIN	2-6#	1/64-1/8
QXTELS666M	M	6	SPIN	6-12#	1/8-1/2

**Your Choice**  
**\$21.99**



## XTRALITE TRIGGER SPIN COMBO

5' 1 Piece Graphite Blank

**CLOSEOUT**

**\$19.99**

#XST0050UL

- Reel:
- Line Cap
  - Precision Micro Adjustable Drag
  - 2 BB System
  - Left or Right Hand Retrieve

- Rod:
- Ultralight 2 PC Graphite Blank
  - Dynaflo Guides
  - Cork/EVA Handle
  - 2-6# Line Wt.



To Order: [www.grizzlyjig.com](http://www.grizzlyjig.com)

# Martin®

## CLASSIC FLY TACKLE

#CC65C  
\$21.95



CADDIS CREEK™ FLY COMBOS  
•Caddis Creek™ single-action reel  
•9', 2-piece rod w/ EVA grip  
•#65 Reel  
•Cork Handle

### CADDIS CREEK FLY REEL

MODEL	LINE CAPACITY	WEIGHT
CC61	50 yds. 20# backing; 30 yds. WF4F	3.1 oz.
CC65	50 yds. 20# backing; 30 yds. WF6F	3.5 oz.

Your Choice  
\$12.95



### EAGLE CLAW WEIGHT FORWARD FLOATING FLY LINE WITH BACKING

\$19.95



ITEM	WEIGHT	YDS TOTAL	COLOR
WMWF5F	5	100	YELLOW
WMWF6F	6	100	BROWN
WMWF8F	8	100	GREEN

### ROLLING FORK 9'6"

7/8 Weight

Cork Handle

IM-6 Graphite

New Closeout Price

~~\$59.95~~  
\$39.95

~~\$59.95~~



This rod makes a great jigging pole! (Compare to the 9'6" Browning Diana)

### MARTIN COMPLETE FISHING KIT

- 8' 3-pc Rod
- Fully loaded reel (backing, fly line, and leader)
- Custom fly assortment
- Getting started booklet

#MRT56TK



\$32.95



To Order: 1-800-305-9866

# spinning, casting & pole reels



## A. West Point Trigger Reel

This is a fantastic little reel that can accomplish big things! Weighing only 5.5 oz, this trigger spin reel is pre-spooled with 43 yards of 8 Lb test line. And, for an ultralight reel, it packs a hefty 4.7:1 gear ratio to bring 'em in. Stainless steel reel cap adds durability. Though designed for fishermen of all skill levels, this is a great reel for beginner fishermen, and has withstood the test of a 7 year old who is rough on equipment... very rough! Left hand retrieve. Line capacity: • 6lb/50 yards • 8lb/40 yards (furnished) • 10lb/25 yards

ITEM: DL1 **\$27.95**

## B. West Point Spinning Reel

The West Point Spinning reel is a 3 ball bearing reel that's designed for light freshwater applications. Weighing only 5.2 ounces, it works great with ultra-light rods and jig poles. • Quick-Change right or left hand retrieve • 4.7:1 gear ratio • Cast aluminum spool with 8 lb. test line • Spare graphite spool • Smooth front drag system • 4 lbs./150 yds., 6 lbs/100 yds., 8lbs./70 yds.

ITEM: BM050 **\$25.95**

## C. ProStaff Spinning Reel

It doesn't say PRO-STAFF for nothing... Smooth action, tough performance, and lots of fun, this little workhorse has a silky-smooth drag for longlining, spider rigging, or any trolling technique. Featuring a stainless steel cap and options for both right- and left-hand retrieves. 5BB (4+1), 5.1:1 gear ratio, with line capacities of: 4lb/220yds, 6lb/150 yds, or 8lb/100 yds.

ITEM: PRO100 **\$39.99**

## D. Buck's Mini-Reel

Weighs only 3 oz.. Measures only 1-1/4" x 3-1/2"  
• Powerful 3.6:1 gear ratio • Anti-reverse lever • Holds 50 Yards of Line. • Audible bait clicker • Tension Control • Quick change right or left hand retrieve.

ITEM: BMR1 **\$19.95**

## E. Quick-Change Crappie Reel

This is really neat little reel that offers the ability to quickly change out line for customers who use pony spools. Great price point, and something unique that is not offered by any competitor. Patented.

ITEM: QC1 **\$6.59**

## F. Quick Change Reel Vertical Mount!

As with our QC1, this is a neat little reel that offers the ability to quickly change out line for customers who use pony spools. This model, though, is vertically mounted like our FR2. Simply cut two notches in the spool as per the instructions, place it in the reel cradle, and you're ready to go! This reel will allow you flexibility in your line choice, and provide you more feel with the line resting on top of your fingers if you choose. Mount this reel for left or right hand retrieve. Great price point!

ITEM: QC2 **\$6.99**

## G. Buck's Best U.L. Crappie Reel Small and Combative!

Lighten your crappie rig for all day vertical jigging with these great little reels. Made of crush resistant ABS material, these reels have 2BB to ensure smooth operation and will allow you to set the drag for optimal rod performance. Weighs just 1.6 oz.!

Gear ratio: 1:1 • Spool diameter: .75 in.  
ITEM: BAN01 **\$13.99**

## H. Universal Pole Reel

*Universal design fits all poles.*  
Flat design lays close to pole. Nylon construction  
• Fingertip drag • Tape-down reel foot • 1:1 ratio

ITEM: NCP33 **\$3.99**

## I. Buck's Best Ultra Lite Crappie Reel 2

*Our best-selling reel: now 30% bigger!*

This light reel is great for all-day jigging. Made of crush resistant ABS material, this reel has 2BB to ensure smooth operation and will allow you to set the drag for optimal rod performance!

LINE CAPACITY:  
6lb test: 75 yards / 8lb test: 35 yards  
10lb test: 30 yards

ITEM: BAN02 **\$13.99**

## J. West Point Crappie Reel

*This Classic Is Now A Better Deal Than Ever!*



Our West Point Crappie Reel – a staple for all crappie fishermen – has been re-tooled for 2013 to provide smoother and more accurate gear action. The audible bait alarm will let you know of the lightest of strikes, and the anti-reverse will ensure no reel movement.

ITEM: FR2-V  
**\$6.99**

To Order: [www.grizzlyjig.com](http://www.grizzlyjig.com)



# Grizzly Elite Reels



Finally a new level wind mini crappie reel.  
Level wind keeps the line laying evenly across the spool. No more line behind the spool.

Features:

- Level wind •Star Drag System •All Metal Frame and Gears
- 3.8:1 Gear Ratio •Two Ball Bearings •Smaller Double Handle
- Frame Size 1-3/4" Diameter X 2" Width •Line Cap 6#/145 Yds., 8#/110 Yds.



#G-5000  
\$26.95

## Mini Crappie Reel



#G-101  
2.8 oz., 1-1/4" X 3-1/2",  
Anti-Reverse Lock,  
Quick change Left to  
Right hand retrieve

\$8.95



## Grizzly Reel and Lock



#G-10  
No Drag

\$3.59

**NEW FOR 2020**

## Grizzly Elite GS-50 Ultra-Lite Spinning Reel

\$24.95

- 6BB
- Instant Anti-Reverse
- 5.2:1 Ratio
- 100 yd/4#
- Super Smooth



#GS-50

Gun Metal  
Copper Accent

## New Model GS-100-N Grizzly Spinning Reel

\$14.95

#GS-100-N



Gun Metal  
Copper Accent

- 2BB
- Anti-Reverse
- Heavy Duty Bail
- 4.7:1 Ratio
- 180 yd/6#

18th Annual  
Grizzly Jig  
Spring Tackle Show  
January 28-31, 2021

Great deals, door prizes,  
FREE seminars, and more.  
All the pros will be there.



## Grizzly Spinning Reel

Copper  
Accent



#GS-100  
2BB  
Anti-Reverse

\$14.95

- Heavy Duty Bail
- Push Button Handle
- 4.7:1 Ratio
- 180 yd/6# 130/10#



# CLOSEOUT REELS



## ULTRALIGHT SPINNING REELS

- All Masterpiece Reels feature:
- Infinite Anti-Reverse
  - Machined Aluminum Handle with Wooden Knob!
  - Machined Aluminum Spool

Line Capacity (Lbs/Yds):  
4/100 6/60

#FCMP-1750AC



**GUN METAL**  
**Aluminum**  
**Infinite**  
**Anti-Reverse**  
**(6) Six**  
**Bearings**

**Gear Ratio: 4.2:1**

**Copper Accent**

**\$14.99**

Limited - #MP-1750SC  
Same Reel Silver Body



## ZEBCO Crappie Fighter UL

- 2 Ball Bearing
- 4.3:1
- Spooled with hi-vis depth indicating line!
- Line Cap 35/6#



#CAFUL

**\$12.99**

## Close Out



## OPTIMAX #OPT-101



### Specifications

- Ball Bearing Drive
- Front Drag
- Graphite Reinforced
- Smooth Ball Roller
- lb/yd 4-115 6-80
- Ratio 5:1:1

Special  
Close-out  
Price!!

**\$6.99**

Get 'em while they last!

## GRIZCO Stillfish Reels

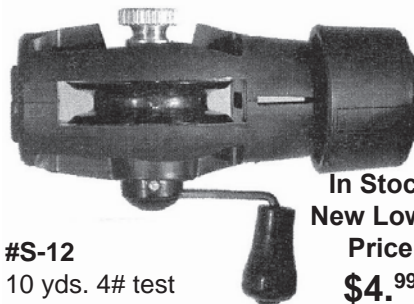

In Stock  
New Lower  
Price  
**\$4.99**

#S-12  
10 yds. 4# test  
Fits 10' Poles  
(3/4" Handle)



EHR **\$3.69**



This manual reel includes locking bands for attachment to telescopic poles or cane poles. Carded.



**\$4.49**



**No. SLMR LINE MINDER REEL**

The Line Minder gives you the ability to change your line length quickly and easily. Makes any pole more effective when easily taped on and used with line guides. Its durable nylon construction makes it maintenance free. Features a positive locking system with easy push-pull locking. Ideal for ice fishing too.

**\$4.99**



**No. SPR SLATER POLE REELS**

The finest quality spring-tension pole reels on the market today! Excellent for adjusting line length in pole fishing when used together with line guides. Ideal for ice fishing too. Built of sturdy nylon for greater durability. Features heavy-duty metal tension screw and durable spring for an effective drag system. Also features an easy-grip nylon crank handle and built-in stripper guide. Easy to install by taping to your pole.

**\$6.99**



**No. SDPR DELUXE POLE REEL**

For the ultimate in pole fishing, it's the Slater Deluxe Pole Reel! Can be mounted in regular reel seats or easily taped on to any pole. Just add reel guides and you've got one of the finest fishing systems on the market. Its heavy-duty nylon construction and compact (2-7/16" diameter) design makes it durable and lightweight (2 oz.). It's versatile too... with the ability to be set for free wheeling, positive lock or operate with its line tensioner drag system. Ideal for ice fishing.



**OVERSTOCK REELS**

**ICEBERG DX**  
#IBG-103



1 Way Clutch  
**\$12.99**

- Size 10 Micro
- 3 BB
- Direct to Guide
- 5.2:1

Great match for Denali!

**Lady Lazer Classic**



#LLZC-2002  
**\$8.99**

- 2 BB
- 5.1:1
- 135 yds/6#
- Size 20

**Lady ICE**  
#LI101



Size 10 Micro  
**\$5.99**

- 1 BB
- 5.1:1
- Thermalube System
- 80 yds/6#

**LAZER LZF-25G Gold**



#LZF-25G  
**\$7.99**

- Ball Bearing Drive
- Front Drag
- Graphite Reinforced
- Smooth Ball Roller
- lb/yd 4-135 6-100
- Ratio 5:1:1

**Mini Reel by Wonder Rod**



#WS2BB  
**\$8.99**

- 2 BB
- 3.6:1
- Star Drag
- School Bus Yellow

**Lazer Blue Combo**



#LZ-562MSC - 5'6"  
#LZ-602MSC - 6'  
**\$15.99**

- 126 yds/8#
- Push Button Folding Handle

2 Pc • Medium Action

To Order: 1-800-305-9866



4 Bearing System

SKELETAL SPEED ROTOR

LEWIS

SPEED SHOOTER

Wally Marshall™ SIGNATURE SERIES  
**TUXEDO BLACK**  
 CRAPPIE RODS & REELS

Wally Marshall Signature Series Spinning Reels

- Lightweight graphite body and skeletal rotor design
- Double anodized aluminum spool with gold accent line
- Strong and balanced aluminum bail
- Thin compact gear box
- Quality 6-bearing system (5+1) with Zero Reverse® one-way clutch bearing
- Collapsible handle adjusts for left/right hand retrieve



6 Bearing System

Wally Marshall Speed Shooter Reels

MODEL	BEARINGS	WT. (OZ.)	LINE CAP. (YD./LB.)	GEAR RATIO	RPT*	MSRP
WMSS75 OR C	3+1	5.0	160/4	5.0:1	22	\$29.99
WMSS100 OR C	3+1	7.8	160/6	5.1:1	23.5	\$29.99

\*Recovery Per Turn.

MODEL	BEARINGS	LINE CAP. (YD./LB.)	WT. (OZ.)	GEAR RATIO	RPT*	MSRP
WSP50 or C	5+1	120/4	4.9	5.0:1	21"	\$27.99
WSP75 or C	5+1	120/6	5.0	5.0:1	22"	\$27.99
WSP100	5+1	160/6	7.8	5.1:1	23.5"	\$27.99

\*Recovery Per Turn.



MR. CRAPPIE® Slab Shaker®

Mr. Crappie® Slab Shaker® Spinning Reels

- Graphite body, rotor and spool
- 2-bearing construction
- Thin compact gear box
- Pre-spooled with premium 6lb. Mr. Crappie mono

MODEL	WT. (OZ.)	LINE CAP. (YD./LB.)	GEAR RATIO	RPT*	MSRP
MCS50	4.6	100/4	5.1:1	22"	\$13.99
MCS75	4.8	120/4	5.1:1	23"	\$14.99
MCS100	6.1	150/6	4.8:1	24"	\$15.99

\*Recovery Per Turn.



MR. CRAPPIE® Solo™ Crappie Reel

- 2-bearing system
- Strong and lightweight graphite frame and spool
- Extended reel foot stem for improved handling and control
- Wide range, multi-disc drag with click function
- Large arbor design reduces line twist and increases line recovery
- Reel weight without line 3oz.
- Pre-spooled with premium Mr. Crappie 6lb. Hi-Vis mono

ITEM SO1 Only \$15.99

SO1 MSRP \$15.99



Mr. Crappie® Jigging Reel

- Dual bearing system
- Adjustable star drag for tension adjustment
- Strong, lightweight polycarbonate frame and spool
- Pre-spooled with premium Mr. Crappie 6lb. Hi-Vis mono

ITEM MC1 Only \$6.99

MC1 MSRP \$6.99



SS1 MSRP \$14.99



SD1 MSRP \$17.99



MCS1 MSRP \$14.99



MUS1 MSRP \$14.99

MR. CRAPPIE® Slab Shaker®

Mr. Crappie® Slab Shaker Crappie Reel

- Strong plated metal frame
- Spool tension adjustment control
- Anti-reverse lever
- SD1 features adjustable star drag
- Pre-spooled with premium 6lb. Mr. Crappie mono

MODEL	WT. (OZ.)	LINE CAP. (YD./LB.)	GEAR RATIO	MSRP
SS1	3.2	90/6	3.6:1	\$14.99
SD1	3.6	90/6	3.6:1	\$17.99

MR. CRAPPIE® Slab Shaker®

Mr. Crappie® Slab Shaker Spincast & UnderSpin Crappie Reel

- Aluminum nose cone and spool
- Ball bearing drive system
- Spool applied adjustable disc drag system
- Selective anti-reverse switch (Underspin only)
- Smooth drag system with easy adjust drag dial
- Adjustable for right or left hand retrieve

MODEL	WT. (OZ.)	LINE CAP. (YD./LB.)	GEAR RATIO	RPT*	MSRP
MCS1	4.9	70/6	4.3:1	12"	\$14.99
MUS1	4.9	70/6	4.3:1	12"	\$14.99

\*Recovery Per Turn.

To Order: [www.grizzlyjig.com](http://www.grizzlyjig.com)



# The 33 Series



## NEW 33 MICRO SERIES

- Tighter Gear Tolerances
- New Drag Control
- Quick Set Anti-Reverse
- Right or Left Hand Retrieve
- Replaces 11 and 11T

MODEL	LINE CAP	PRICE
33MTKA	4#	\$16.95
33MCKA	4#	\$16.95

## 33 MICRO GOLD SERIES

- 3 Ball Bearing Drag
- Continuous Anti-Reverse
- 4.3:1 Gear Ratio
- Replaces 11 and 11T Gold

MODEL	LINE CAP	PRICE
33MTK-GOLD	4 lb.	\$26.95
33MCK-GOLD	4 lb.	\$26.95



## 33 MAX SERIES

- Aut Ball Bearing Drive
- Gold 3 Ball Bearing Drive
- Continuous Anti-Reverse
- 2.6:1 Gear Ratio
- Replaces AUT733 and 733 Gold

MODEL	LINE CAP	PRICE
33MXK	20 lb.	\$27.95
33MXK-GOLD	20 lb.	\$33.95

## More Classic Reels



## PRO STAFF 888

- Cont Anti-Reverse
- Dual CAM Drag
- All Metal Gears
- 2.58:1 Gear Ratio
- 3 Ball Bearing Drive

MODEL	LINE WT	PRICE
NEW 888HA	20 lb.	\$31.95



## 808 SALTFISHER

- Ball Bearing Drag
- All Metal Gears
- Adjustable Magnum Drag
- Strong Metal Foot
- Oversized Power Knob

## 808 BOWFISHER

MODEL	LINE WT	PRICE
808SFish	20 lb.	\$34.95
808Bowfish	200 lb. Braid	\$39.95



## PRO STAFF SERIES

- All Metal Drive Train
- Dual-CAM Drag System
- 3 Ball Bearings
- 3.3:1 Gear Ratio
- Pre Spooled with Cajun Red Line

MODEL	LINE WT	PRICE
PS-2010	6 lb.	\$18.95
PS-2020	10 lb.	\$18.95



## ZEBCO STANDARDS

- All Metal Gears
- Stainless Steel Pickup Pins
- Wide Range Adjustable Drag
- Steel Crank Handles

MODEL	LINE WT	PRICE
STAND-202M	10 lb.	\$7.39
STAND-404M	15 lb.	\$11.95
STAND-606MBK	20 lb.	\$17.95
STAND-808HA	20 lb.	\$19.95



## BIG CAT XT

- 4 Ball Bearing
- Ratio 2.6/1
- Anti Reverse
- Power Handle

MODEL	LINE CAP	PRICE
BCXTSC	110/25	\$31.95

## OMEGA PRO

- Cont Anti-Reverse
- Triple CAM Multi-Disc Drag
- 7 Bearings (6 Ball and 1 Roller Bearing)
- Free Spare Spool
- Z03 Has 3X Postive Pickup Pins

MODEL	LINE CAP	PRICE
PRO-Z02	6/85	\$69.95
PRO-Z03	10/85	\$74.95

## OMEGA

- Cont Anti-Reverse
- Triple CAM Multi-Disc Drag
- 7 Bearings (6 Ball and 1 Roller Bearing)
- Brass Worm Gear
- Left or Right Hand Retrieve

MODEL	LINE CAP	Your Choice
OMEGA-Z02	6/85	\$59. <sup>95</sup>
OMEGA-Z03	10/85	

## DELTA

- All Metal Construction
- Triple CAM Disc Drag
- 5 Stainless Steel Bearings
- Multi Point Pickup Pins
- Ceramic Line Guides

MODEL	LINE CAP	Your Choice
DELTA-ZD2	6/85	\$44. <sup>95</sup>
DELTA-ZD3	10/85	

## PLATINUM

- All Metal Gears
- Triple CAM Disc Drag
- 5 Ball Bearing Drive
- Cont Anti-Reverse
- Right or Left Hand Retrieve

MODEL	LINE CAP	PRICE
33KPL	10/130	\$32.95

## ZEBCO AUTHENTIC The History Maker

- All Metal Gears
- Triple CAM Disc Drag
- Ball Bearing Drive
- Auto Bite Alert
- Ceramic Pickup Pins
- Right or Left Hand Retrieve

MODEL	LINE CAP	PRICE
AUTH11T MICRO (Trigger)	4/75	\$14.95



# QUANTUM®

# ZEBCO®

REELS



OPTIX

**Optix Features**

- Aluminum Long Stroke spool design
- Size 05-30 3BB 5.3:1
- Size 80 4BB 4.7:1

MODEL	ACTION	LINE WT	PRICE
OP05D	UL	4#	\$21.95
OP10D	L	6#	\$23.95
OP20D	L	8#	\$24.95
OP30D	M	10#	\$24.95
OP80D	CAT	25#	\$31.95



ZEBCO Quick Cast w/ Casting Trigger

#ZQ10 4# \$21.95  
#ZQ20 6# \$21.95



ZEBCO STINGER Big Water Reel

- Ball Bearing Drive
- Quick Set
- Front Drag
- 5.1:1 Ratio
- 20-30# Hi Vis Line

Your Choice  
**\$24.99**

#SSP60  
#SSP80

**Big Cat 350 XT Bait Cast Reel**

- 3BB Drive
- Anti-Reverse Clutch
- 6.3:1 Ratio
- Line Cap 200/20#

**\$59.95**

#BCXT350



**CATFISH REELS**

Big Water Catfish



BLUE RUNNER SALTWATER

- Ball Bearing Drive
- Long Stroke Spool
- Multi-Stop Anti-Reverse
- Saltwater Protected Finish

BLR80F

**\$29.99**

**33 Black Max**



#33MXK

- 4BB
- Anti-Reverse
- Spooled with 20# Cajun

Special  
**\$21.95**

**Big Cat 80 XT Spinning Reel**

#BCXT80

**\$39.95**



- 5 BB Drive
- Line Cap 205/30#
- 4.9:1 Ratio
- Anti-Reverse Clutch

**Protege Zebco Bait Cast Reel**

Left Hand #PR101S **\$19.95**



Right Hand #PR100S



REGULAR PRICE  
**\$39.95**

**\$21.95**

- 3BB Drive
- All Metal Gears
- Aluminum Spool
- Continuous Anti-Reverse

*LH is ideal for slow vertical trolling!*

**33 Max Camo**



#33MXCAMO

- 2BB
- Anti-Reverse
- Bite Alert
- Spooled with 20# Mono

Special  
**\$21.95**

# Shakespeare®

## SYNERGY® TI



SYN2TI6UB  
\$17.99



NEW MICRO  
\$16.99



SYN2TIMSX

- SYN2TI6B 6#/90 YDS \$17.99
- SYN2TI10B 10#/85 YDS \$17.99
- SYN2TI20B 17#/150 YDS \$21.99

- 2 Ball bearings
- Stainless steel front cone and rear cover
- Gear driven, adjustable multi-drag system
- Insta-Gram™ dual pick-up pins
- Right or left retrieve
- On/off bait clicker

## ALPHA®

ALPHA  
#ALPHA2LPB  
\$26.95

- Ball bearing.
- Lightweight graphite spool filled with 12 lb. line.
- Adjustable magnetic cast control.
- Graphite frame and side plates.
- High speed 6.2:1 gear ratio.



Model	Line Cap	Ratio	Trigger	Class
ALPHA20B	110 yds/4	5.2:1	No	Ultra Light
ALPHA25B	115 yds/4	5.2:1	Yes	Ultra Light
ALPHA30B	115 yds/6	5.2:1	Yes	Light

Easy Cast  
Trigger



\$12.95

## ATS

ATS15X

- 2 Ball bearing
- 290 yd/12#
- SS level wind
- On/off bait clicker



Your Choice  
\$34.95

ATS15LCX  
Line Counter



To Order: [www.grizzlyjig.com](http://www.grizzlyjig.com)





### D-SPIN 500B

**SPECIAL**  
**\$12.99**

- Ball Bearing Drive
- Ultralight Action
- 4.9:1 Ratio
- Digigear
- ABS

#DS-1000B



### UNDERSPIN USXD

- Convenient casting trigger
- Tin coated rotating line pick-up
- Large diameter line guide
- Smooth Rear Drag
- Prewound with premium line



Model	Action	Gear Ratio	Line	Drag	Price
US40XD	UL	4.1:1	4#	Front	\$17.95
US80XD	ML	4.3:1	8#	Rear	\$20.95
US120XD	ML	4.3:1	12#	Rear	\$23.95

### SILVERCAST-A

- 3 Ball Bearings
- Tin coated rotating line pick-up
- Large diameter line guide
- Smooth dial drag
- Prewound with premium line

Model	Action	Bearing	Line	Price
SC80A	ML	3	8#	\$29.95
SC100A	M	3	10#	\$29.95
SC120A	MH	3	12#	\$29.95
SC170A	H	3	17#	\$29.95



### MINICAST MC40

**\$26.95**

- Aluminum Body
- Front Disc Drag
- Prewound with 4# line
- Smaller than ultralite



### REVROS LIGHT

- Digigear
- Infinite Anti Reverse
- 4 Ball Bearings **#REVL1000**
- Twist Buster or
- 110 yds/6# **#REVL2000**
- 5.2:1 Ratio

**\$49.95**



### ACCUDEPTH PLUS

LINE COUNTER REEL

#ADP17LCB

**\$59.95**

- Line Counter Built In
- 270 yd/10#
- Ball Bearing Drive

**6 or More**  
**\$55.95**



### SWEEPFIRE-B

- DIGIGEAR
- 2 Ball Bearing
- TWIST BUSTER
- ABS

**\$18.99**



#SWF1000-2B

ULTRA LITE



# President®

## Pflueger® President® Spinning Reels

Extremely light in weight, very smooth handling, but solidly built to cover a wide range of fishing situations. The President's precision 10-bearing system includes 9 strategically placed stainless steel ball bearings, plus a one-way clutch bearing in the instant anti-reverse system (6720 has an 8-bearing system) and Sure-Click Bail®. Stainless steel sideplate screws for durability.



Model	Bearings	WT	Line Cap	Ratio	Price
PRESSP20X	7+1	5.9 oz.	4/105	5.2:1	\$49.99
PRESSP25X	9+1	7.2 oz.	4/115	5.2:1	\$59.99



### Trigger Spin

Model	Bearings	WT	Line Cap	Ratio	Price
PRES6USCX	4+1	8.4 oz.	6/90	3.4:1	\$39.99

### Spincast

Model	Bearings	WT	Line Cap	Ratio	Price
PRES6SCX	4+1	8.3 oz.	6/90	3.4:1	\$39.99
PRES10SCX	4+1	10.7 oz.	10/75	3.8:1	\$39.99



## TRION NEW Trigger Spins



Model	WT	Line Cap	Ratio	Price
TRI6USCB	6.4 oz.	6/90	3.4:1	\$29.99
TRI10USCB	10.4 oz.	10/75	3.8:1	\$29.99



Model #1195X

## AUTOMATIC FLY REEL

- Aluminum Alloy Spool & Frame
- Stainless Steel Spring
- Tension Release
- Fold Down Trigger



\$31.95

# HT Direct Import Reels

## MICRO GOLD TUNDRA



\$12.<sup>95</sup>

- Features: #TN500-GOLD  
#TN500-SILVER
- 4 Ball Bearings
  - Special Zinc Drive
  - Thermalube System

## Denali All Season 2BB



DS-102CG Gold (pictured)

- Features: • Infinite Anti-Reverse \$8.<sup>99</sup>

Therma-Lube keeps the reel operating in the coldest weather.

## OPTIMAX SILVER



- Features: #OPT-101-S  
\$6.<sup>99</sup>
- Ball Bearing Drive
  - Front Drag
  - Smooth Ball Roller
  - 115/4# 80/6#
  - 5.1:1 Ratio

## POLAR FIRE



Microsize #10

- Features: #PFB-106A  
\$19.<sup>95</sup>
- Machined Aluminum
  - Thermalube System
  - 5.1 to 1 Gear Ratio
  - Front Drag
  - Direct to Guide Technology

## DENALI ALL SEASON REEL



#DS-103WH

- Special Price \$16.99
- 3 Ball Bearings
  - Infinite Anti-Reverse
  - 5.2:1 Ratio

Therma-Lube Lubricant keeps reel operating in the coldest weather.

## Grizzly Jig Exclusive \$6.99 each



- #WR-2R Red #WR-2 Hi-Vis Yellow  
#WR-2P Pink #WR-20 Hi-Vis Orange #WR-2B Black  
Mini Crappie Reels

## INTRIGUE ULTRALIGHT



#IS-502SC

\$8.99

- 2 Ball Bearing
- Silver Plated Spool
- 4.1:1 Gear Ratio

## MICRO FLY REEL

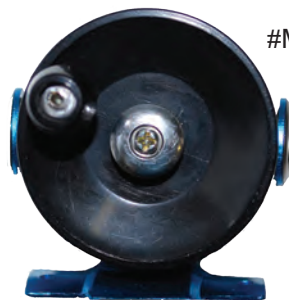

#MFR-1

\$6.99

- Lightweight
- 1-3/4" Spool
- Left or Right Retrieve
- Adjustable Drag
- For Ultralite Mono Only

## OPTIMAX YELLOW OPTIMAX RED



#OPT-101-Y  
#OPT-101-R

- \$6.99 each
- Ball Bearing Drive
  - Front Drag
  - Smooth Ball Roller
  - 5.1:1 Ratio
  - 115/4# 80/6#

To Order: 1-800-305-9866



## Vicious Braid for Snagging

Lo-Vis Green 150 yd Spools  
Also available in Hi-Vis



- #BPG-65 lb Test
- #BPG-80 lb Test
- #BPG-100 lb Test



## P-Line

Hi-Vis  
Fluorescent Green

**CXX**  
**Extra Strong**



600 yd Spools  
\$14.95 each

- |           |     |
|-----------|-----|
| CXXQFG-6  | 6#  |
| CXXQFG-8  | 8#  |
| CXXQFG-10 | 10# |
| CXXQFG-12 | 12# |
| CXXQFG-15 | 15# |

See more bites  
with hi-vis.

## P-LINE



Moss Green

### P-Line CXX XTRA

Strong Copolymer

Pound-for-pound, diameter-for-diameter, P-Line CXX is tougher and stronger than all other national brands.

Lb. Test	Yards	Price
CXXFG-4#	300	\$8.99
CXXFG-6#	300	\$8.99
CXXFG-8#	300	\$9.49
CXXFG-10#	300	\$9.99
CXXFG-12#	300	\$9.99
CXXFG-15#	300	\$9.99



Clear

### P-Line Floroclear

The best of both worlds.

Fluorocarbon coating ensures near invisibility underwater. Tough copolymer construction for unbelievable knot strength and durability.

Lb. Test	Yards	Price
FCCF-4#	300	\$8.99
FCCF-6#	300	\$8.99
FCCF-8#	300	\$9.49
FCCF-10#	300	\$9.99
FCCF-12#	300	\$9.99
FCCF-15#	300	\$9.99



Family Friends Fishing Fun



# Crappie.com

America's Crappie Fishing Community

# FOR THE ULTIMATE STRIKE

## VICIOUS PANFISH

The ultimate combination of strength, abrasion resistance, low stretch, low memory and castability.

You will see more bites.

Model	Test	Yds	Price
PYL-2	2#	330	\$6.49
PYL-4	4#	330	\$6.49
PYL-6	6#	330	\$6.49
PYL-8	8#	330	\$6.49
PYL-10	10#	330	\$6.49



### 1/4# SPOOL



### YOUR CHOICE

**\$7.99**

## HI-VIS

Model	Test	Yds
PYLQ-2	2#	3920
PYLQ-4	4#	2960
PYLQ-6	6#	2360
PYLQ-8	8#	1700
PYLQ-10	10#	1500

## CLEAR

Model	Test	Yds
PCLQ-2	2#	3920
PCLQ-4	4#	2960
PCLQ-6	6#	2360
PCLQ-8	8#	1700
PCLQ-10	10#	1500

### 330 yd Spool

Size	Clear Blue	HV Gold	Price
4#	SOFS4-26	SOFS4-26-GD	\$7.99
6#	SOFS6-26	SOFS6-26-GD	\$7.99
8#	SOFS8-26	SOFS8-26-GD	\$8.49
10#	SOFS10-26	SOFS10-26-GD	\$8.99
12#	SOFS12-26	SOFS12-26-GD	\$8.99
14#	SOFS14-26	SOFS14-26-GD	\$8.99
17#	SOFS17-26	SOFS17-26-GD	\$8.99
20#	SOFS20-26	SOFS20-26-GD	\$10.99

### 250 yd Spool

Size	Clear Blue	Hi-Vis	Price
25#	SOFS25-26	N/A	\$10.99
30#	SOFS30-26	N/A	\$10.99



## Hi-Vis

### Flame Green

- No Memory
- No Stretch
- Ultra-Thin Diameter
- 3 Times Stronger Than Mono

**\$16.99**

#BFLFS\_\_GG

# Test	Diameter
4#	1#
6#	2#
8#	3#
10#	4#
14#	6#
20#	8#



#CLOWVISF\_\_C

**\$5.99**

330 yd spool

How Does Cajun Red Line Disappear?

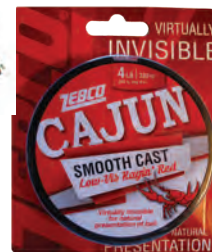

4#	
6#	
8#	
10#	
12#	
RED 14#	
20#	



Water filters out certain colors more quickly than others. The color red is the first color to be completely filtered. This means that once Cajun Red™ line goes under water, it starts to become "invisible" to fish in as little as three feet of water! All the fish see is the lure.



CLEAR

NEON TANGERINE

HI-VIS YELLOW

330 Yd. Spools Elite			
Lb. Test/Dia	Clear Blue	Hi-Vis Yellow	Price
4/.008"	661-104	661-104Y	10.99
6/.101"	661-106	661-106Y	10.99
8/.011	661-108	661-108Y	10.99
10/.012"	661-110	661-110Y	11.99
12/.014"	661-112	661-112Y	11.99
14/.015"	661-114	661-114Y	11.99
20/.018"	661-120	661-120Y	12.99
*25/.020"	661-125	661-125Y	12.99
*30/.022"	661-130	661-130Y	12.99
*250 yds			

330 Yd. Spools Siege 15XTough		
Lb. Test/Dia	Neon Tangerine	Price
20/.018"	662-120NT	12.99
*25/.020"	662-125NT	12.99
*30/.022"	662-130NT	12.99
*250 yds		

## DAY-BRIGHT BOBBER STOPS

### Knot-Bead-Reusable Tube

Item	PK	Price
BS12CN	12	\$1.79
BS25P	25	\$2.95

Bright Flo Colors  
Hi-Vis Pink & Chartreuse



## CRAPPIE STALKER™

STEALTH FLOATS

\$2.79 ea

- Made of Paulownia wood—NOT BALSAAA!!
- An extremely sensitive float made especially for finicky Crappies.
- Available in three sizes, specifically designed for use with 1/32, 1/16, and 1/8 oz. baits and/or jigs.
- Available only as an "In-Line Slider" float.
- Complete "how-to-use" instructions included.

#CSF-



3/8" 1/32 oz.  
2/8" 1/16 oz.  
1/2" 1/8 oz.

## WALLEYE STALKER™

STEALTH FLOATS

\$2.79 ea

- Made of Paulownia wood—NOT BALSAAA!!
- An extremely sensitive float made especially for those "elusive" Walleyes.
- Available in three sizes, specifically designed for use with 1/8, 1/4, and 3/8 oz. baits and/or jigs.
- Available as underwater style Slip Float.
- Complete "how-to-use" instructions included.

#WSF-



1/8 oz.  
1/4 oz.  
3/8 oz.

# CAJUN LINE™

## Cajun Ragin' Red™

1/4 lb. Spool  
#CLLOWISQ\_ \_ \_



	Test	Yds.
20C	20#	650
30C	30#	450
40C	40#	375
50C	50#	275

Our #1 selling catfish line!

\$7.99 per spool



**Nark Tattle Board Side Planer**

#SPB-R Right  
#SPB-L Left



**YOUR CHOICE \$19.99**

- Tattle Flag system already installed
- Fish up to 150' beside your boat

**PROWLER PLANER BOBBERS**

- Set Prowlers to go LEFT or RIGHT or FLIP DIRECTION with a POP
- Prowlers are 3" long and weigh 1/2 oz
- "Slip-Rig" style
- Molded smooth skin polyurethane foam.

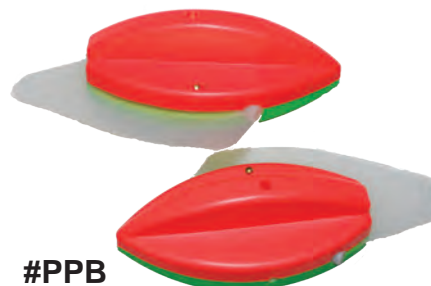

#PPB  
**\$12.95**  
2 PK



**Slime Line – High Vis Green**

**325 yd Spool**

ITEM	LB. TEST	PRICE
SL-4SG-325	4	\$11.95
SL-6SG-325	6	\$11.95
SL-8SG-325	8	\$11.95
SL-10SG-325	10	\$12.95
SL-15SG-325	15	\$12.95
SL-20SG-325	20	\$12.95
SL-30SG-325	30	\$12.95
SL-40SG-325	40	\$13.95
SL-50SG-325	50	\$13.95

**1/4 LB. Spool**

ITEM	YDS.	PRICE
SL-4SG-1/4-4#	2600	\$39.95
SL-6SG-1/4-6#	2400	\$39.95
SL-8SG-1/4-8#	1930	\$39.95
SL-10SG-1/4-10#	1730	\$39.95

**1 LB. Spool**

ITEM	YDS.	PRICE
SL-30SG-1-30#	1750	\$49.95
SL-40SG-1-40#	1370	\$49.95
SL-50SG-1-50#	1300	\$49.95
SL-60SG-1-60#	960	\$49.95



**Mr. Crappie® Monofilament Line**

- Field tested and approved by Wally Marshall
- Designed specifically for small reel usage
- Extremely abrasion resistant formula
- Low memory increases casting distance

**Mega Spools**

Model	lb. Test	Dia. in.	YDS.	PRICE
MC4CL	4	.008	2000	\$6.99
MC6CL	6	.009	1500	\$6.99
MC8CL	8	.010	1200	\$6.99
MC10CL	10	.011	1000	\$6.99
MC4HV	4	.008	2000	\$6.99
MC6HV	6	.009	1500	\$6.99
MC8HV	8	.010	1200	\$6.99
MC10HV	10	.011	1000	\$6.99
MC4CM	4	.008	2000	\$6.99
MC6CM	6	.009	1500	\$6.99
MC8CM	8	.010	1200	\$6.99
MC10CM	10	.011	1000	\$6.99

**500 yard Filler Spools**

Model	lb. Test	Dia. in.	PRICE
MC4F5CL	4	.008	\$4.99
MC6F5CL	6	.009	\$4.99
MC8F5CL	8	.010	\$4.99
MC10F5CL	10	.011	\$4.99
MC4F5HV	4	.008	\$4.99
MC6F5HV	6	.009	\$4.99
MC8F5HV	8	.010	\$4.99
MC10F5HV	10	.011	\$4.99
MC4F5CM	4	.008	\$4.99
MC6F5CM	6	.009	\$4.99
MC8F5CM	8	.010	\$4.99
MC10F5CM	10	.011	\$4.99

To Order: 1-800-305-9866



Good for..  
Trotline  
Chalk Line  
Fishing Line  
Plumb Line  
Seine Twine

# 100% NYLON TWINE

Mason Twine  
Net Repair  
Craft  
Duck Decoy  
Staging Twine  
Gardening

¼ lb. Spool White		
Item #	Size	Price
M4W-9	9	2.99
M4W-12	12	2.99
M4W-15	15	2.99
M4W-18	18	2.99
M4W-21	21	2.99
M4W-24	24	2.99
M4W-36	36	2.99
¼ lb. Tarred		
M4T-9	9	3.79
M4T-12	12	3.79
M4T-15	15	3.79
M4T-18	18	3.79
M4T-24	24	3.79
M4T-36	36	3.79



1 Pound White				
Item #	Size	Approx. Feet	Approx. Test #	Price
MW-9	9	2,350	80	7.99
MW-12	12	1,890	100	7.99
MW-15	15	1,560	120	7.99
MW-18	18	1,155	160	7.99
MW-21	21	915	200	7.99
MW-24	24	750	240	7.99
MW-30	30	635	280	7.99
MW-36	36	550	320	7.99
MW-48	48	320	440	7.99
MW-60	60	300	560	7.99
MW-72	72	260	640	7.99
1 Pound Tarred				
MT-9	9	2,350	80	9.99
MT-12	12	1,890	100	9.99
MT-15	15	1,560	120	9.99
MT-18	18	1,155	160	9.99
MT-21	21	915	200	9.99
MT-24	24	750	240	9.99
MT-30	30	635	280	9.99
MT-36	36	550	320	9.99
MT-48	48	320	440	9.99
MT60	60	300	560	9.99
MT72	72	260	640	9.99

## MARINER Green Braided Nylon Twine



1 LB. TUBES				
Stock #	Size	Feet	Approx. Break	Price
GBN118	18	900	150 lb.	\$13.99
GBN124	24	745	190 lb.	\$13.99
GBN136	36	450	280 lb.	\$13.99
GBN148	48	305	415 lb.	\$13.99
GBN160	60	290	550 lb.	\$13.99
GBN172	72	195	615 lb.	\$13.99



NYLON		Price Per Spool
<b>Rope Solid Braid</b>		
*Nylon 3/16" x 500'		\$36.50 #RO-4051
*Nylon 1/4" x 200'		\$24.99 #RO-4050
*Nylon 3/8" x 250'		\$46.99 #RO-4053

### ¼ LB. TUBES













Stock #	Size	Feet	Approx. Break	Price
GBN412	12	463	95 lb.	\$4.49
GBN418	18	287	155 lb.	\$4.49
GBN424	24	180	190 lb.	\$4.49
GBN436	36	125	285 lb.	\$4.49



Nylon 3/16" x 50'	\$4.99	#RO-3120
<b>Seasense Multi-Purpose Braided Camo Rope</b>	\$6.99	#RO-2902
3/8" x 50'		

To Order: [www.grizzlyjig.com](http://www.grizzlyjig.com)



	<b>Balsa Wood Float Size</b>	
Item #W-320 \$10.99 dz \$24.99 bg/36	 <b>320</b>	Item #CB-320 \$13.99 dz
Item #W-488 \$10.99 dz \$24.99 bg/36	 <b>488</b>	Item #CB-488 \$13.99 dz
Item #W-490 \$10.99 dz \$24.99 bg/36	 <b>490</b>	Item #CB-490 \$13.99 dz
Item #W-510 \$10.99 dz \$24.99 bg/36	 <b>510</b>	Item #CB-510 \$13.99 dz
Item #W-583 \$10.99 dz \$24.99 bg/36	 <b>583</b>	Item #CB-583 \$13.99 dz
Item #W-586 \$10.99 dz \$24.99 bg/36	 <b>586</b>	Item #CB-586 \$13.99 dz
Item #W-783 \$10.99 dz \$24.99 bg/36	 <b>783</b>	Item #CB-783 \$13.99 dz
Item #W-786 \$10.99 dz \$24.99 bg/36	 <b>786</b>	Item #CB-786 \$13.99 dz
Item #W-788 \$10.99 dz \$24.99 bg/36	 <b>788</b>	Item #CB-788 \$13.99 dz
Item #W-790 \$12.99 dz \$26.99 bg/36	 <b>790</b>	Item #CB-790 \$14.99 dz

**Beads**



8mm-ORANGE \$1.00/10 pk  
4mm-ORANGE \$2.95/100 pk  
5mm-CHARTREUSE \$2.95/100 pk

**Style-A**

\$3.99 50pk



**Rubber  
Bobber Stops**

15 pk



Item #	Style	Price
LC-3	4-8#	\$1.00

**Arnold Speed Stop**

5 stops  
per card



Item #	Price
A-SS50-1	\$1.29 ea

**Eagle Claw  
Rubber Bobber Stops**

10 pk



Item #	Style	Price
07090-005	8-12#	\$1.69



Your Choice  
3 for \$2.09

Color  
YG - Yellow/Green

Size	Shape	Stock #
7/8"	Pear	RP78P-3YG
1"	Pear	RP3P-3YG
1 1/4"	Pear	RP4P-3YG



Weighted  
Snap On  
Floats

Your Choice  
\$1.99

Pear Size	Stock #	Shape	Pcs.
*1 1/4"	MP125W-2YG	Pear	2
1 1/2"	MP150W-2YG	Pear	2
1 3/4"	MP175W-2YG	Pear	2

Cigar Size	Stock #	Shape	Pcs.
2"	M0BW-2YG	Cigar	2
2 1/2"	M2BW-2YG	Cigar	2



Packed with Bobber  
Stops & Beads.

Mr. Crappie Slippers are designed to set your lure at any desired depth while trolling, casting or targeting suspended crappies above structures. Mr. Crappie Slippers' bright yellow and green color combination makes them easy to detect strikes.

Color  
YG - Yellow/Green

Unweighted Size	Shape	Stock #	Pcs.
1 1/2"	Cigar	M00B-SF-3YG	3 2.29
2"	Cigar	M0B-SF-3YG	3 2.29
2 1/2"	Cigar	M2B-SF-3YG	3 2.29



Slip Floats-  
Packed with Bobber  
Stops & Beads.

The perfect easy way to put a slip bobber on the line. Just put the line in the slot and twist it on. It comes off the same easy way. No line cutting or abrasion. Extra cap included with bobber stops and beads in each package.



Color  
YG - Yellow/Green

Unweighted Size	Shape	Stock #	Pcs.
7/8"	Pear	M087P-108YG	2 1.99
1"	Pear	M100P-109YG	2 1.99
1 1/4"	Pear	M125P-110YG	2 1.99
1 1/2"	Pear	M150P-111YG	2 2.09
2"	Pear	M200P-113YG	2 2.09
1 1/2"	Cigar	M00B-150YG	2 2.09
2"	Cigar	M0B-200YG	2 2.09
2 1/2"	Cigar	M2B-250YG	2 2.09
3"	Cigar	M4B-300YG	2 2.09

Weighted Size	Shape	Stock #	Pcs.
1"	Pear	M100PW-109YG	2 2.09
1 1/4"	Pear	M125PW-110YG	2 2.20
1 1/2"	Pear	M150PW-111YG	2 2.35



Cam-Action Red Gold Black

Style #	Size	PK	Price
MC35B-	2	22	3.29
MC35B-	1	20	3.29
MC35B-	1/0	18	3.29

Style #	Size	PK	Price
MC38B-	2	22	3.29
MC38B-	1	20	3.29
MC38B-	1/0	18	3.29

Style #	Size	PK	Price
MC34B-	2	22	3.29
MC34B-	1	20	3.29
MC34B-	1/0	18	3.29



1 1/4" RPT125  
1 1/2" RPT150



The special click-click sound gets the fish going.

Your Choice  
\$2.09- - 3 Pack

3 Pk. Individual Pack Size	Stock#	Shape	Pcs.
1"	RP3-3YG	Yellow/Green	3
1 1/4"	RP4-3YG	Yellow/Green	3
1 1/2"	RP5-3YG	Yellow/Green	3

# COMAL

## Cigar Slip Floats with Bead



Red/White  
Bag of 50

Model	Size	Price
CB150RW	1-1/2"	\$14.59
CB200RW	2"	\$14.99
CB250RW	2-1/2"	\$14.99
CB300RW	3"	\$15.99

# COMAL

## Slotted Cigar Peg Floats



Red/White  
Bag of 50

Model	Size	Price
C150S	1-1/2"	\$11.49
C200S	2"	\$12.49
C250S	2-1/2"	\$13.99
C300S	3"	\$14.49

# COMAL

## Pear Peg Floats



Red/White  
Bag of 50

Model	Size	Price
P150RW	1-1/2"	\$10.99
P200RW	2"	\$11.49

# COMAL

## Pear Snap Floats



Red/White  
Bag of 50

Model	Size	Price
PS-075RW	3/4"	\$15.99
PS-100RW	1"	\$16.49
PS-125RW	1-1/4"	\$16.99
PS-150RW	1-1/2"	\$17.99
PS-200RW	2"	\$21.99

# COMAL

## Weighted Oval Snap Floats



Red  
Bag of 25

Model	Size	Price
WOS150R	1-1/2"	\$12.99
WOS200R	2"	\$13.49
WOS250R	2-1/2"	\$13.99

# COMAL

## Weighted Round Snap Floats



Red/White  
Bag of 25

Model	Size	Price
WSS075RW	3/4"	\$10.99
WSS100RW	1"	\$12.49
WSS125RW	1-1/4"	\$12.99
WSS150RW	1-1/2"	\$13.99

Crappie Cork



The Crappie Cork's plastic line-friendly insert is designed to grab the bobber stop without needing a bead.



**\$1.79 ea**

CC010	- 1/16 oz.
CC015	- 1/8 oz.
CC020	- 1/4 oz.
CC025	- 3/8 oz.

### THILL® CRAPPIE CORK

1 per card

The Crappie Cork takes the guesswork out of matching jig and cork sizes. The amount of weight that the cork will float is printed right on the brightly-colored Crappie Cork

## E-Z Crappie Float



Slotted Floats  
3PK  
\$1.59



#J87610	1.5"
#J87609	2"
#J87608	2.5"

## Genuine Porcupine Quills

6"  
\$1.79 EA  
\$18.99 DZ

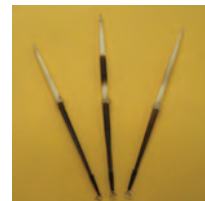

8"  
\$1.99 EA  
\$20.99 DZ

Bream Floats

LIMITED

To Order: 1-800-305-9866

**COMAL  
Cigar Style  
Springstick**

50 Pk

Item No.	Size	Price
CHL150RW	1-1/2"	\$15.99
CHL200RW	2"	\$16.99
CHL250RW	2-1/2"	\$17.99
CHL300RW	3"	\$18.99

**COMAL  
Pear Style  
Springstick**

50 Pk

Item No.	Size	Price
PHL100RW	1"	\$15.99
PHL150RW	1-1/2"	\$16.99
PHL200RW	2"	\$18.99
PHL225RW	2-1/4"	\$23.99

**COMAL  
Oval Slip**

50 Pk



Item No.	Size	Price
OB150RW	1-1/2"	\$14.99
OB200RW	2"	\$16.99
OB250RW	2-1/2"	\$18.49

**COMAL  
Cigar Peg Float  
Red/White**

50 Pk



Item No.	Size	Price
C150RW-3/8	1-1/2"	\$9.49
HC150RW-1/2	1-1/2"	\$9.49
C200RW	2"	\$10.49
C250RW	2-1/2"	\$11.49
C300RW	3"	\$12.49

**COMAL  
Cigar Peg Float  
Red/Green**

50 Pk



Item No.	Size	Price
CG150-3/8	1-1/2"	\$10.49
HCG150-1/2	1-1/2"	\$10.49
CG200	2"	\$10.89
CG250	2-1/2"	\$11.99
CG300	3"	\$13.59

**COMAL  
Cigar Peg Float  
Flo-Yellow**

50 Pk



Item No.	Size	Price
C150Y-3/8	1-1/2"	\$9.49
HC150Y-1/2	1-1/2"	\$9.49
C200Y	2"	\$10.49
C250Y	2-1/2"	\$11.49
C300Y	3"	\$12.59

**COMAL  
Cigar Snap  
Red**

50 Pk



Item No.	Size	Price
CS150R	1-1/2"	\$15.99
CS200R	2"	\$16.99
CS250R	2-1/2"	\$17.99
SC300R	3"	\$19.49

**COMAL  
Cigar Snap Weighted  
Red**

25 Pk



Item No.	Size	Price
WCS150R	1-1/2"	\$11.49
WCS200R	2"	\$12.99
WCS250R	2-1/2"	\$13.49
WSC300R	3"	\$13.99

**COMAL  
Round Snap-On  
Red**

50 Pk



Item No.	Size	Price
SS075R	3/4"	\$16.99
SS100R	1"	\$17.49
SS125R	1-1/4"	\$17.99
SS150R	1-1/2"	\$18.99
SS175R	1-3/4"	\$20.99
SS200R	2"	\$26.59
SS300R*	3"	\$20.99

\*25 pack

**COMAL PLASTIC  
Red/White**

50 Pk



Item No.	Size	Price
PBS075RW	3/4"	\$7.99
PBS100RW	1"	\$8.99
PBS125RW	1-1/4"	\$9.99
PBS150RW	1-1/2"	\$11.59
PBS175RW	1-3/4"	\$14.39
PBS200RW	2"	\$18.49
PBS250RW*	2-1/2"	\$14.49

\*25 pack

**Spring Slip**



**Balsa**  
Slim 3/8"

**\$1.19 ea**



#UAC-586

#UAC-786

**Comal  
Toothpick**  
50 per Bag 1"

**\$9.49**

#M100R



# B · A · N · G Fish Attractors for Catfish



**Anise**  
#BANG-A

Pure Anise

5 oz.  
Aerosol  
Can

**Your Choice**  
**\$6.99**

**Garlic**  
#BANG-G

Pure Garlic  
Oil Extract



5 oz.  
Aerosol  
Can

*Spray it on night crawlers, cut bait, or sponge hooks!*

## Dead Ringers

#BR-CAT

**Blood Red  
Catfish Spray  
Attractant**

**\$6.99**

**Concentrated**

*Spray on any baits or lures.*



4 oz. Pump  
Spray Bottle

## Grizzly Jig Co Skip Jack Fish Oil



Fast Acting Fish Attractant  
with 35% Omega-3 Fatty Acids

Not for human consumption.

For crappie or  
panfish:  
Spray on jigs, live  
minnows, or night  
crawlers.

For catfish:  
Soak cutbait, meat  
chunks, or mix with  
dip bait for use on  
sponge hooks.

8 oz.  
Economy Bottle  
with Flip Cap

#SJO-8  
**\$6.99**



1/2 gallon (64 oz.)  
Sized for  
Jugger or Blockers  
with Screw Cap

#SJO-64  
**\$16.99**



1 gallon (128 oz.)  
For the serious  
Trot Liner

#SJO-128  
**\$29.99**



## Bonehead Tackle Liquid Scent



GARLIC  
#BHGSC



SHAD  
#BHSSC

**Your Choice**  
**\$6.99**

1.25 oz.

Drip top cap provides easy application while on the water.

**Brad Chappell Guide Service**

Grenada Lake Crappie Trips May thru Sept.  
Guided Crappie Fishing Trips  
Lodging Available  
On Lake Washington, MS  
**601.317.6681**

Follow us on Twitter  
like us on facebook

To Order: 1-800-305-9866





Berkley® PowerBait Dough Bait Colors



**\$3.99**







**Crappie Nibbles Colors**

- |  |   |
|--|---|
| CNW   | CNC  |
| CNP   | CNY  |
| CNBN  |   |
- White Chartreuse  
Pink Yellow  
Blue Neon

**\$4.99**



**Sparkle Crappie Nibbles Colors**

- |   |   |
|---|---|
| SCNP   | SCNNC  |
| SCNWF  | SCNGR  |
| SCSN   |   |
- Platinum Neon Chartreuse  
Wildfire Goldrush  
Blue Ice

**\$4.99**



**Chroma-Glow™ Crappie Nibbles Colors**

- |   |   |
|---|---|
| CNW-G  | CNC-G  |
| CNRG   | CNY-G  |
- Glow White Glow Chartreuse  
Glow Pink Glow Yellow



2.1 oz. jar

*Gulp Alive absorbs 20% more attractant than regular Gulp.*

ITEM	Cricket COLOR	PRICE
CR1-BRE	Breen	\$5.99
CR1-CH	Chartreuse	\$5.99
CR1-CRBR	Cricket Brown	\$5.99
CR1-GP	Green Pumpkin	\$5.99

ITEM	Maggots COLOR	PRICE
GAMG-W	White	\$5.99



**Power® Honey Worm**

**\$4.59**



The Power Honey Worm design emulates the larval stages of an insect's life cycle, and is great for ice fishing and open water bobber fishing. Formulated especially for trout and panfish.

- Formulated for trout and panfish
- Lifelike appearance
- Great for ice fishing and open water bobber fishing.

- HWY-Yellow  
HWN-Natural  
HWR-Red

**Power Wiggler®**



Regular Wigglers

PW-White	\$4.59
PW-Pink	\$4.59
PW-Chartreuse	\$4.59



**Slab Bites**

**\$2.99**

- Exclusive Crappie Magnet Scent
- Designed to stay on the hook longer.
- Slide Slab Bite on the hook.
- 1.2 oz.



WHITE  
#CM-WT



CHARTREUSE  
#CM-CH



SILVER GLITTER  
#CM-SG

To Order: [www.grizzlyjig.com](http://www.grizzlyjig.com)

**Call in the Crappie with Kodiak Fish Attractants. Our unique injector puts our natural, long lasting, powerful, Kodiak scent... "inside" your tube jigs.**



Item	Scent
KOD-M	MINNOW
KOD-S	SHAD
KOD-W	WAXWORM
KOD-N	NIGHTCRAWLER

**\$5.99 Per Injector**

*Fish Attractant for Crappie, Bass and Bluegill*

## Dead Ringers

### Grizzly's Dead Ringer Jig Spray & Oil

Crappie, Bluegill, Bass Attractant

**\$4.99 ea**



#CC-JS      #CO      #BL-JS

Use Crystal Clear on your hands to cover up sunscreen, repellants, etc.

Try our jig sprays on all your jigs, cut bait, live bait, and on all our Dead Ringer plastic baits.

#CC-JS and #BL-JS come in 4 oz. pump spray bottle.  
#CO comes in 4 oz. squirt bottle.



### EZ Drift Bait Pens



Crappie Bait Pen

Usable with most small Crappie pellets, nibbles, and bites. **MADE IN THE USA**

#TBP  
**\$19.99**

### Bait Injector Pen



Perfect for injecting your favorite bait into the eye hole of the jig. Paste and nibbles of all shapes, sizes and colors can be used in the "Injector Pen".

#BIP  
**\$19.99**

Try your luck at one of more than 500 gaming machines or at any of our 9 hot tables. Enjoy good eats while staying at our RV Park that's open year-round and located right by the water. What are you waiting for?



Century Casino  
Caruthersville  
777 E 3rd St.  
Caruthersville  
MO 63830  
573-333-6000

centy.com/caruthersville

Facebook Instagram Twitter

Welcome to the **Winners' Zone!**

**CENTURY CASINO**  
Caruthersville

# One-Pole Jigging...Old Tactic Still Fun & Productive

By: Tim Huffman

“One-pole jigging has been around since the existence of fishing,” says Bart Gillon, owner of Rod Safe and pro staff for Grizzly Jig Company. “Spider rigging came on the scene and is a good way to catch more fish, but many fishermen still want to feel the bite and “the thump” that one-poling provides.”

Gillon says a fisherman’s favorite method is often determined by the water he or she fishes. It might be a jigging lake, spider rigging or fast trolling lake. A weekend fisherman can use the method that’s most fun and what works at his home water. Competitive fishermen have used spider rigging because it simply produces more fish on most lakes compared to other techniques.

“My rule of thumb when jigging is to use the lightest line and jig for the condition. In water less than 10 feet, I’ll use a 1/16-ounce jig with a big hook. If going deeper or if it’s windy, I’ll go to a bigger weight.

“Another rule of thumb is to put the jig in the right spot. No matter what the weather, lake color, sun or clouds or bait, putting it in front of the fish is the most important thing. If fish are sluggish af-



ter a front, I will keep it still for a long time. Aggressive fish usually hit on the fall or after a very short time when stopped.

New for 2020

The Grizzly Pro Balance is a new pole for 2020. It’s a 10-foot, IM-7 Graphite with an adjustable butt weight system. Grizzly owner Louie Mansfield has always weighted his long poles, but the new Pro allows a fisherman to add or remove as needed for a perfect balance.

“The one-pole market is getting ready to explode due to new electronics,” says Gillon. “We are seeing fishermen catching more fish with one pole than they can with four. I believe those fish have always been there to catch with one pole, but the new electronics makes it easier.

“I use a Grizzly Elite for my one-poling and it is weighted nicely, and the Pro will be even better. Balance is so important. You are going to get tired if you’re jigging all day. The weighted butt will keep the weight of the pole from pulling down on your wrist and wearing you out. Along with less fatigue, the good balance makes the pole easier to handle and increases sensitivity to feel more bites.”

Two other new products are Grizzly’s GS50 and GS100 reels. The 50 is an ultralight, six ball bearing reel with all the bells and whistles. It’s the best reel yet from Grizzly. The newly redesigned 100, two ball bearing reel, is a good all-around choice at an economical price.







PiranhaMAX Series



Helix Series



Solix Series



# HUMMINBIRD®

## PiranhaMAX Series

ITEM#	MODEL	PRICE
410150-1	PIRANHAMAX 4	\$99.99
410170-1	PIRANHAMAX 4 PT	\$169.99
410160-1	PIRANHAMAX 4 DI	\$149.99

## HELIX 5 Series

ITEM#	MODEL	PRICE
410190-1	HELIX 5 SONAR G2	199.99
410250-1	HELIX 5 SONAR GS PT	349.99
410200-1	HELIX 5 DI G2	249.99
410210-1	HELIX 5 CHIRP GPS G2	299.99
410260-1	HELIX 5 CHIRP GPS G2 PT	449.99
410220-1	HELIX 5 CHIRP DI GPS G2	349.99
410220-1NAV	HELIX 5 CHIRP DI GPS G2 NAV	399.99
410230-1	HELIX 5 CHIRP SI GPS G2	499.99

## HELIX 7 Series

ITEM#	MODEL	PRICE
410930-1	HELIX 7 CHIRP GPS G3	499.99
410940-1	HELIX 7 CHIRP MDI GPS G3	549.99
410940-1NAV	HELIX 7 CHIRP MDI GPS G3 NAV	599.99
410950-1	HELIX 7 CHIRP MSI GPS G3	699.99
410950-1NAV	HELIX 7 CHIRP MSI GPS G3 NAV	749.99
414060-1	HELIX 7 CHIRP DS GPS G3N	549.99
411070-1CHO	HELIX 7 CHIRP MDI GPS G3N CHO	549.99
411070-1	HELIX 7 CHIRP MDI GPS G3N	599.99
411080-1	HELIX 7 CHIRP MSI GPS G3N	799.99

## HELIX 8 Series

ITEM#	MODEL	PRICE
410810-1	HELIX 8 CHIRP DS GPS G3N	699.99
410820-1CHO	HELIX 8 CHIRP MDI GPS G3N CHO	799.99
410820-1	HELIX 8 CHIRP MDI GPS G3N	899.99
410830-1	HELIX 8 CHIRP MSI GPS G3N	1199.99

*Humminbird Accessories  
In Stock!*

## HELIX 9 Series

ITEM#	MODEL	PRICE
410840-1	HELIX 9 CHIRP DS GPS G3N	899.99
410850-1CHO	HELIX 9 CHIRP MDI GPS G3N CHO	999.99
410850-1	HELIX 9 CHIRP MDI GPS G3N	1099.99
410860-1	HELIX 9 CHIRP MSI GPS G3N	1499.99

## HELIX 10 Series

ITEM#	MODEL	PRICE
410870-1	HELIX 10 CHIRP DS GPS G3N	1199.99
410880-1CHO	HELIX 10 CHIRP MDI GPS G3N CHO	1299.99
410880-1	HELIX 10 CHIRP MDI GPS G3N	1399.99
410890-1	HELIX 10 CHIRP MSI GPS G3N	1999.99

## HELIX 12 Series

ITEM#	MODEL	PRICE
410900-1	HELIX 12 CHIRP DS GPS G3N	1899.99
410910-1CHO	HELIX 12 CHIRP MDI GPS G3N CHO	1999.99
410910-1	HELIX 12 CHIRP MDI GPS G3N	2099.99
410920-1	HELIX 12 CHIRP MSI GPS G3N	2499.99

## SOLIX 10 Series

ITEM#	MODEL	PRICE
411090-1CHO	SOLIX 10 CHIRP DS/MDI GPS G3N	2199.99
411010-1	SOLIX 10 CHIRP MSI GPS G2	2499.99

## SOLIX 12 Series

ITEM#	MODEL	PRICE
411100-1CHO	SOLIX 12 CHIRP DS/MDI GPS G3N	2599.99
411030-1	SOLIX 12 CHIRP MSI GPS G2	3099.99

## SOLIX 15 Series

ITEM#	MODEL	PRICE
411100-1CHO	SOLIX 15 CHIRP DS/MDI GPS G3N	3199.99
411050-1	SOLIX 15 CHIRP MSI GPS G2	3699.99

# TROLLING MOTOR MODELS



## FRESHWATER BOW-MOUNT

### ELECTRIC-STEER CONTROL



	ULTREX™	ULTERRA®	TERROVA®	POWERDRIVE™
<b>MOTOR SPECS</b>				
MAX THRUST (LB)	80, 112	80, 112	55, 80, 112	45, 55, 70
SHAFT LENGTHS (IN)	45, 52, 60	45, 60, 72	45, 54, 60, 72	48, 54, 60
MOUNT	Lift-Assist	Auto Stow/Deploy	Lift-Assist	Deploy-Assist Lever
SPEEDS	Variable	Variable	Variable	Variable
CONTROL	Foot Pedal and Remote	Foot Pedal and Remote	Foot Pedal and Remote	Foot Pedal or Remote
WARRANTY	3-Year	2-Year	2-Year	2-Year
<b>FEATURES</b>				
BUILT-IN MEGA IMAGING®	Side/Down	Side/Down	Down	—
i-PILOT LINK (GPS)**	•	•	•	—
i-PILOT (GPS)	•	•	•	•
UNIVERSAL SONAR 2	•	•	•	•
AUTOPILOT*	•	•	•	•
COPILOT*	•	•	•	•

### CABLE-STEER CONTROL



	FORTREX®	MAXXUM®	EDGE
	80, 112	70, 80	45, 55, 70
	45, 52	42, 52	36, 45, 52
	Lift-Assist/Bowguard	Bowguard	Latch & Door
	Variable	5-Speed or Variable	5-Speed
	Foot Pedal	Foot Pedal or Tiller	Foot Pedal or Tiller
	2-Year	2-Year	2-Year
	Down	—	—
	—	—	—
	—	—	—
	•	—	—
	—	—	—
	—	—	—

### TRANSOM MOUNT HAND CONTROL

#### ENDURA 5 SPEED

- Telescoping Tiller
- Thrust 30, 40, 45, 50, 55#
- Shaft Length 30", 36", 42"
- Prop Power

#### ENDURA MAX-MAXIMIZER

- Telescoping Tiller
- Thrust 40, 45, 50, 55#
- Shaft Length 36", 42"
- Prop Power

#### TRAXXIS

- Tilt/Extended Tiller
- Thrust 45, 55, 72, 80#
- Shaft 36", 42"
- Shaft Length 26", 42"
- Prop Weedless Wedge 2
- One Hand Stow
- Push to Test Battery Meter



# 2020 PRICING

### ULTREX COMBO (i-PILOT LINK PRE-INSTALLED) MSI

1368865	ULTREX 80/MSI/IP LINK_BT	45"	\$3,099.99
1368866	ULTREX 80/MSI/IP LINK_BT	52"	\$3,149.99
1368867	ULTREX 80/MSI/IP LINK_BT	60"	\$3,199.99
1368885	ULTREX 112/MSI/IP LINK_BT	45"	\$3,199.99
1368886	ULTREX 112/MSI/IP LINK_BT	52"	\$3,249.99
1368887	ULTREX 112/MSI/IP LINK_BT	60"	\$3,299.99

### ULTREX COMBO (i-PILOT LINK PRE-INSTALLED) MDI

1368860	ULTREX 80/MDI/IP LINK_BT	45"	\$2,899.99
1368861	ULTREX 80/MDI/IP LINK_BT	52"	\$2,949.99
1368862	ULTREX 80/MDI/IP LINK_BT	60"	\$2,999.99
1368880	ULTREX 112/MDI/IP LINK_BT	45"	\$2,999.99
1368881	ULTREX 112/MDI/IP LINK_BT	52"	\$3,049.99
1368882	ULTREX 112/MDI/IP LINK_BT	60"	\$3,099.99

### ULTREX COMBO (i-PILOT LINK PRE-INSTALLED) US2

1368810	ULTREX 80/US2/IP LINK_BT	45"	\$2,749.99
1368811	ULTREX 80/US2/IP LINK_BT	52"	\$2,799.99
1368830	ULTREX 112/US2/IP LINK_BT	45"	\$2,849.99
1368831	ULTREX 112/US2/IP LINK_BT	52"	\$2,899.99

### ULTREX COMBO (i-PILOT PRE-INSTALLED) MDI

1368850	ULTREX 80/MDI/IP_BT	45"	\$2,499.99
1368851	ULTREX 80/MDI/IP_BT	52"	\$2,549.99
1368852	ULTREX 80/MDI/IP_BT	60"	\$2,599.99
1368870	ULTREX 112/MDI/IP_BT	45"	\$2,599.99
1368871	ULTREX 112/MDI/IP_BT	52"	\$2,649.99
1368872	ULTREX 112/MDI/IP_BT	60"	\$2,699.99

### ULTREX COMBO (i-PILOT PRE-INSTALLED) US2

1368800	ULTREX 80/US2/IP_BT	45"	\$2,349.99
1368801	ULTREX 80/US2/IP_BT	52"	\$2,399.99
1368820	ULTREX 112/US2/IP_BT	45"	\$2,449.99
1368821	ULTREX 112/US2/IP_BT	52"	\$2,499.99
1368822	ULTREX 112/US2/IP_BT	60"	\$2,549.99

### ULTERRA COMBO (i-Pilot pre-installed) MDI

1358982	ULTERRA 80/MDI/IP_BT	45"	\$2,449.99
1358980	ULTERRA 80/MDI/IP_BT	60"	\$2,499.99
1358992	ULTERRA 112/MDI/IP_BT	45"	\$2,699.99
1358990	ULTERRA 112/MDI/IP_BT	60"	\$2,749.99
1358993	ULTERRA 112/MDI/IP_BT	72"	\$2,899.99

### ENDURA MAX TRANSOM MOUNT SERIES

1352140	ENDURA MAX 40	36"	\$224.99
1352145	ENDURA MAX 45	36"	\$244.99
1352150	ENDURA MAX 50	36"	\$269.99
1352155	ENDURA MAX 55	36"	\$289.99
1352156	ENDURA MAX 55	42"	\$299.99

### ENDURA C2 TRANSOM MOUNT SERIES

1352230	ENDURA C2 30	30"	\$109.99
1352240	ENDURA C2 40	36"	\$169.99
1352245	ENDURA C2 45	36"	\$194.99
1352250	ENDURA C2 50	36"	\$214.99
1352251	ENDURA C2 50	42"	\$224.99
1352255	ENDURA C2 55	36"	\$234.99
1352256	ENDURA C2 55	42"	\$244.99

### TERROVA BOW-MOUNT COMBO (i-PILOT LINK PREINSTALLED, FOOT PEDAL INCLUDED) MDI

1358883	TERROVA 80/MDI/IPLINK_BT	45"	\$2,349.99
1358884	TERROVA 80/MDI/IPLINK_BT	60"	\$2,399.99
1358837	TERROVA 112/MDI/IPLINK_BT	60"	\$2,649.99
1358838	TERROVA 112/MDI/IPLINK_BT	72"	\$2,799.99

### TERROVA BOW-MOUNT COMBO (i-PILOT PREINSTALLED, FOOT PEDAL INCLUDED) MDI

1358880	TERROVA 80/MDI/IP_BT	45"	\$1,999.99
1358881	TERROVA 80/MDI/IP_BT	60"	\$2,049.99
1358882	TERROVA 80/MDI/IP_BT	72"	\$2,199.99
1358835	TERROVA 112/MDI/IP_BT	60"	\$2,299.99
1358836	TERROVA 112/MDI/IP_BT	72"	\$2,449.99

### TERROVA BOW-MOUNT COMBO (i-PILOT PREINSTALLED, FOOT PEDAL INCLUDED) US2

1358856	TERROVA 55/US2/IP_BT	45"	\$1,549.99
1358857	TERROVA 55/US2/IP_BT	54"	\$1,599.99
1358893	TERROVA 80/US2/IP_BT	45"	\$1,799.99
1358894	TERROVA 80/US2/IP_BT	60"	\$1,849.99
1358895	TERROVA 80/US2/IP_BT	72"	\$1,999.99
1358846	TERROVA 112/US2/IP_BT	60"	\$2,099.99
1358847	TERROVA 112/US2/IP_BT	72"	\$2,249.99

### FORTREX BOW-MOUNT SERIES

1368660	FORTREX 80	45"	\$1,299.99
1368661	FORTREX 80	52"	\$1,329.99
1368670	FORTREX 80/US2	45"	\$1,399.99
1368665	FORTREX 80/MDI	45"	\$1,599.99
1368671	FORTREX 80/US2	52"	\$1,429.99
1368666	FORTREX 80/MDI	52"	\$1,629.99
1368687	FORTREX 112	45"	\$1,449.99
1368695	FORTREX 112/US2	45"	\$1,549.99
1368675	FORTREX 112/MDI	45"	\$1,749.99
1368676	FORTREX 112/MDI	52"	\$1,779.99

### MAXXUM BOW-MOUNT SERIES

1368561	MAXXUM 70	42"	\$899.99
1368562	MAXXUM 70	52"	\$949.99
1368630	MAXXUM 70/SC/HAND	52"	\$799.99
1368560	MAXXUM 70/SC	42"	\$799.99
1368640	MAXXUM 80/HAND	52"	\$999.99

### EDGE BOW-MOUNT SERIES

1355946	EDGE 45	36"	\$399.99
1355947	EDGE 45	45"	\$429.99
1355935	EDGE 45/HAND	45"	\$299.99
1355956	EDGE 55	45"	\$569.99
1355957	EDGE 55	52"	\$599.99
1355963	EDGE 55/HAND	52"	\$499.99
1355970	EDGE 70	45"	\$649.99
1355971	EDGE 70	52"	\$699.99

### TRAXXIS TRANSOM MOUNT SERIES

1368707	TRAXXIS 45	36"	\$329.99
1368715	TRAXXIS 55	36"	\$369.99
1368716	TRAXXIS 55	42"	\$379.99
1368720	TRAXXIS 70	42"	\$469.99
1368730	TRAXXIS 80	42"	\$579.99

Factory Reconditioned  
Minn Kota



Call to check stock!

1 Year Warranty

# Replacement Foot Pedals



RIPTIDE ST/TERROVA FOOT PEDAL  
ST/TerFP Coded \$149.<sup>99</sup>



RIPTIDE SP/POWERDRIVE V2 FOOT PEDAL  
PDV2FP Coded \$99.<sup>99</sup>

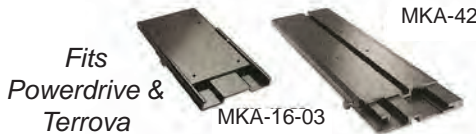

Fits Powerdrive & Terrova

MKA-16-03 \$59.<sup>95</sup>  
MKA-42 (Short) \$129.<sup>99</sup>  
MKA-52/62 (Long) \$149.<sup>99</sup>

**ALUMINUM QUICK RELEASE BRACKETS (MKA-16-02, MKA-42, MKA-52/62)**  
For easy, quick removal of any Terrova, PowerDrive V2, PowerDrive (MKA-16-02), Fortrex or Maxxum (MKA-42, MKA-52/62) bow-mount trolling motor. Extruded aluminum design with side screw provides quiet and secure locking system. MKA-42 fits 42" shaft foot control motors, 42" and 52" shaft hand control motors. MKA-52/62 fits 52" and 62" shaft foot control motors and 62" shaft hand control motors.

## MINN KOTA ON BOARD CHARGING SYSTEMS



\$199.<sup>99</sup>

MK 315D

**MK 315D**  
3 BANKS  
5 AMPS OUTPUT PER BANK  
15 AMPS TOTAL OUTPUT



MK 106D

**MK 106D**  
1 BANK  
6 AMPS OUTPUT  
6 AMPS TOTAL OUTPUT



MK 110P

### PORTABLE CHARGERS

Bring the action right to your boat with an easy-to-use portable charger. Each model features Automatic Multi-Stage Charging to keep you on the water longer and is designed to extend the overall life of your batteries.

### SPECIFICATIONS

Fully automatic multi-stage charging  
LED display indicates power ON, charging, full charge and check connection  
Short circuit and reverse polarity protection prevents chargers from operating if improperly connected to the battery  
For use with 12V/6 cell batteries (50-130 amp hour rating) that are Flooded/Wet Cell, Maintenance Free or Starved Electrolyte (AGM) only  
FCC Compliant

Designed to UL marine standard 1236



MK105PD

MK110PD

1 BANK  
5 AMPS OUTPUT  
5 AMPS TOTAL OUTPUT  
**\$59.<sup>99</sup>**

1 BANK  
10 AMPS OUTPUT  
10 AMPS TOTAL OUTPUT  
**\$84.<sup>99</sup>**

## MinnKota Digital On Board Chargers



\$149.<sup>99</sup>

MK 210D

**MK 210D**  
2 BANKS  
5 AMPS OUTPUT PER BANK  
10 AMPS TOTAL OUTPUT



\$249.<sup>99</sup>

MK 220D

**MK 220D**  
2 BANKS  
10 AMPS OUTPUT PER BANK  
20 AMPS TOTAL OUTPUT



# Minn Kota Electric Anchor Winch

## >> DECKHAND 40 \$299.99

- Davit can be mounted at base of DeckHand or in remote position on boat deck
- 40-lb anchor capacity (anchor not included)
- Pre-spooled with 100 feet of 800-lb test nylon rope
- Universal davit stows anchor horizontally to eliminate anchor swing
- Anchor shackle allows for quick changes between anchors
- Runs on 12-volt battery (not included)



## >> DeckHand 40 Remote Switch

25' cord allows you to operate the DeckHand 40 from anywhere on the boat (optional accessory).



**\$49.99**



## << NEW! DECKHAND 25 \$219.95

- 25-lb anchor capacity (anchor not included)
- Includes davit for stowing most styles of anchors
- Pre-spooled with 60 feet of 800-lb test nylon rope
- Runs on 12-volt battery (not included)

## Trolling Motor Quick Connect (MKR-12)

For wiring where a plug and socket cannot be used. Heavy-duty 10-gauge connectors.



**\$9.99**

**GRIZZLY SPECIAL**



## >> DECKHAND 25R \$269.95

The DeckHand 25R's new 25-foot corded remote control lets you operate your DeckHand from anywhere on the boat.

- 25-lb anchor capacity (anchor not included)
- Includes davit for stowing most styles of anchors
- Pre-spooled with 60 feet of 800-lb test nylon rope
- Runs on 12-volt battery (not included)

## Transducer Mounting Kit

#MKR-15



**\$19.95**

Allows mounting on lower unit of bow- or transom-mount motors. Rugged, durable construction. Fits transducers of all major manufacturers.



## Jonathan Moore

*Professional Guide*  
REELFOOT LAKE, TENNESSEE

*Crappie • Bluegill • Catfish • Ducks*

1247 Glass Rd.  
Obion, TN 38240

Cellular  
(731) 431-7891

To Order: 1-800-305-9866

## Trac Anchor Winches

3 Sizes to Choose From  
25 lb., 35 lb., or 45 lb.

**Fisherman  
Anchor  
Winch**



#T10108-25-G3

### TRAC

#### Fisherman Anchor Winch

Designed for anchors up to 25 lbs., and suitable for fishing boats, utility boats, john boats and runabouts. Panel switch mounts easily on the winch case or at the boat's helm. Anti-reverse with an internal clutch to prevent free spooling. Includes 100' of 3/16" nylon anchor line.

**\$181.99**

**Pontoon  
Anchor Winch**



#T10109-35-G3

#### Pontoon Anchor Winch

Designed for anchors up to 35 lbs., and suitable for pontoon boats. Panel switch mounts easily on the winch case or at the boat's helm. Anti-reverse with an internal clutch to prevent free spooling. Includes 100' of 3/16" nylon anchor line.

**\$209.99**



### TRAC ANCHOR SECOND SWITCH KIT COMPLETE WITH WIRING HARNESS

#T10115

**\$33.99**

### TRAC ANCHOR WIRELESS REMOTE KIT

#T10216

**\$54.99**

For all Trac freshwater and saltwater winches.



10/6RS

### Standard Rod Saver Set

The original "Rod Saver" set of two straps holds up to five rods. The set consists of one 10" strap for the handle end of the rod and one 6" strap for the tips. Stainless steel hardware included. Packaged.

**10/6RS 2003750**

**\$13.95**



PM12/6

### Pro Model Stretch Rod Saver Set

This set contains one 12" strap with elastic for the handle end and one 6" strap for the tip end. Holds up to seven rods. Stainless steel mounting hardware included. Packaged for display.

**PM12/6RS 2003805**

**\$16.99**



PM14/8

### Pro Model Stretch Rod Saver Set

This set contains two straps: One 14" strap with elastic for accommodating additional rods for the handle end and one 8" strap for the tip end. This set holds up to eight rods. Includes all necessary stainless steel hardware.

**PM14/8RS 2003815**

**\$19.99**

### Rod Hold-Down

	Description	
7-52234	18"	\$6.99
7-52235	12"	\$5.99

Deck mount rod hold-down. Includes one rubber hold-down strap, one eye strap and three stainless steel screws.



### Zamak Cleat

	Description	
7-54032	4.5" Cleat	\$5.99
7-54034	6" Cleat	\$7.99

Traditional Style Chrome Plated Zamak Cleats. #8 fasteners required. Open Base.



# BOATMAN SPORTS MARINE PRODUCTS

## Bilge Pump Switch Panel

	Description
1- 57444	Bilge Pump Switch Panel

3 Way Bilge Pump Switch with 10 Amp Breaker. On-Off-Auto. Marine grade tin wire and aluminum face plate. Booted toggle switch 3-1/4" x 2". L.E.D. power indicators.



\$19.95

## Plug-in Light Base - Chrome

	Description
7-51273	Plug-in Light Base

Chrome plated Zamak stern light base with swivel cover. 2-pin contact socket for standard and angled poles is keyed to prevent incorrect insertion. Direct replacement for Attwood® and other competitive brands.



\$12.95

## All-Round Stern Light

	Description	
7-51251	24"	14.95
7-51253	36"	16.95
7-51255	48"	18.95

2-pin standard stowaway plug-in pole with frosted globe and lens and 360° two mile visibility. Standardized pole fits Attwood® and other competitive two pin bases. Available in 24", 36" and 48" lengths.



## Rocker Switch Panel

	Description	
1-51400	4.5" x 5" - 4 Gang	\$38.95
1-51401	4.5" x 6.5" - 6 Gang	

Illuminated rocker switches with boots and screw in fuses. Corrosion resistant aluminum face. Includes extra labels & mounting hardware.



\$29.95



## Tear Drop Bow Light

	Description	
7-51220	10" Angled	14.95
7-51221	10" Straight	14.95

Red and green light provides visibility for 1 mile, 225° visibility. Plastic housing with aluminum pole.



## Deck & Baitwell Plugs

	Description	
1-54850	1/2" - Pair	4.95
1-54854	5/8" - Pair	5.79
1-54858	11/16" - Pair	5.95
1-54856	3/4" - Pair	5.99
1-54860	7/8" - Pair	5.99
1-54847	7/16" - Pair	4.95



The neoprene body, stainless steel plates and adjustable brass cam snap provide a leak-proof, non slip seal. Sold in Pairs.

## LED Indicator Guide Lights

	Description	
59350	LED Guide Lights	\$31.95



Attaches to trailer or guide-on posts for loading and unloading. Springs help prevent breakage. 24" Long.

## Stainless Steel Drain Plugs

	Description
7-0563	1" Snap Type - Each
7-0564	1" Twist Type - Each

Drain plugs constructed of stainless steel. Offers a smooth, tight seal.

\$4.99

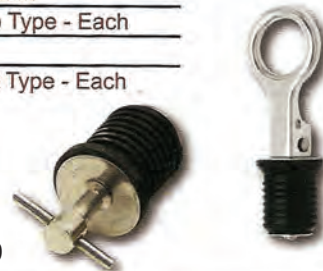

\$4.99

## Brass Drain Plugs

	Description
7-0093	1" Snap Type - Each
7-0094	1" Twist Type - Each

Drain plugs constructed of brass with a rubber expansion plug offers a smooth, tight seal.

Your Choice  
\$3.69



Fuel Lines

All the features of our Standard Fuel Line Assemblies plus the added benefit of EPA Compliant Fuel Hose. USCG Type B1-15 SAE J1527

MULTI-LAYER / LOW PERMEATION

951606ULP7	Universal	5/16"x6'	\$34.95
93806ULP7	Universal	3/8"x6'	\$31.95
93812ULP7	Universal	3/8"x12'	\$44.95
93806MLP7	Mercury New Style	3/8"x6'	\$39.95

POR	Suzuki	3/8"x6'	---
93806YLP7	Yamaha	3/8"x6'	\$39.95
93806ELP7	Johnson/Evinrude	3/8"x6'	\$39.95
POR	Nissan/Tohatsu	3/8"x6'	---
93806HLP7	Honda	3/8"x6'	\$39.99
93806FLP7	Force	3/8"x6'	\$39.95



Gen III Primer Bulbs

	Diameter	
93516LP7	5/16"	17.95
93038LP7	3/8"	17.95
53074	5/16" & 3/8"	19.95

Gen III primer bulbs. USCG approved.

Chrysler® Force®

	Description	\$10.95
53212	Female - 3/8" Barb	

OEM 197787-3; Ref 18-8106; Chrome Plated Brass; Tank or Engine 3/8" Barb; Female

Chrysler® Force®

	Description	\$6.99
53213	Tank - 1/4" NPT	

OEM 23-F213238-2; Ref 18-8071; Chrome Plated Brass; Tank 1/4" NPT; Male

Mercury®

	Description	\$5.95
1- 53224	Female - 5/16" Barb	

OEM ; Ref; Nylon/Brass; 5/16" Barb; Female

Mercury®

	Description	\$4.95
53204	Engine - 3/8" Barb 2-prong	

OEM 2-13563A7; Ref 18-8076; Resin; Engine 3/8" Barb 2-prong; Female

Mercury®

	Description	\$7.95
53205	Tank 1/4" NPT 2-prong	

OEM N/A; Ref 18-8077; Brass; Tank 1/4" NPT 2-prong; Male

Mercury®

	Description	\$9.95
53210	Engine - 3/8" Barb 1/4" NPT	

OEM 22831A3; Ref 18-8068; Aluminum; Engine 3/8" Barb 1/4" NPT; Female

Mercury®

	Description	\$9.95
53211	Tank - 3/8" Barb	

OEM 30185A3; Ref 18-8084; Aluminum; Tank 3/8" Barb; Male

Mercury®

	Description	\$10.95
1- 53223	Tank or Engine 3/8" Barb	

OEM 22831A3; Ref 18-8083; Aluminum; Tank or Engine 3/8" Barb; Female

Mercury®

	Description	\$4.95
1- 53214	Engine 3/8" Barb 2-prong	

OEM 22-13563A7; Ref 18-8076; Resin; Engine 3/8" Barb 2-prong; Female



### Trolling Motor Connectors



Designed to be flush-mounted, this socket makes connection of your trolling motor quick and easy. Wire the plug to the motor end, and add 8- or 10-gauge heavy gauge cable from the battery to the socket, and you're ready to go. Includes butt connectors. Works on 12V or 24V motors.

White	Connector	Type	Wire
1-51441 -M	Male	2-wire	10 Ga. 10.95
1-51442 -B	Female	2-wire	10 Ga. 12.95
1-51443 -M	Male	3-wire	10 Ga. 11.95
1-51444 -B	Female	3-wire	10 Ga. 13.95
1-51445 -B	Male	2-wire	8 Ga. 13.95
1-51446 -M	Female	2-wire	8 Ga. 11.95
1-51447 -B	Male	3-wire	8 Ga. 14.95
1-51448 -M	Female	3-wire	8 Ga. 13.95

B=Boat Recept M=Motor Plug

### Trolling Motor Plugs - 3 Prong

	Type	Style	
7-51557	Female (Boat)	3-prong	\$10.95
7-51558	Male (Motor)	3-prong	
51558-57 Male & Female			\$19.95/Set

3 prong locking plug or socket for trolling motors.

\$10.95

### In-Line Waterproof Fuse Holder

1-51404 \$2.95  
AWG - Accepts 12-18 wire. Yellow. For 1/4" x 1-1/4" fuses. 30 Amp.



### Heavy Duty Battery Clips

7-51011 \$4.99  
Spring loaded copper plated 3" battery clips. Color coded plastic handles. Fits up to 6 gauge wire. 30 Amp. Sold in pairs.



### Battery Clips

7-51008 \$2.99  
Spring loaded copper plated 3" battery clips commonly used for aerators and portable lights. Color coded coated handles. 15 Amp. Sold in pairs.



### Gator Battery Clips

1-51010 \$2.99  
Spring loaded copper plated battery clips commonly used for aerators and portable lights. 30 Amp. Sold in pairs.



### Breaker Mounting Bracket

BRK-1 \$2.99  
For convenient mounting of trolling motor breaker. Use with manual or automatic trolling motor breakers.



### Trolling Motor Transducer Mount

52648 \$6.99  
Stainless steel clamp with nylon base. This simple-to-install bracket allows you to mount your transom transducer to your trolling motor.



### Trolling Motor Pull Cord

7-52245 \$5.99  
Durable, abrasion resistant 48" nylon pull cord with heavy-duty plastic handle.



### Trolling Motor Mounting Isolators

2000595 \$12.95  
Set of four "Type-T" isolators for mounting bow mount trolling motors. Set consists of four mounting isolators and four mounting bolts.



### Automatic Circuit Breaker

	Description	
400/165 54-120	20 Amp	\$5.99
400/170 54-130	30 Amp	
400/175 54-140	40 Amp	
400/180 54-150	50 Amp	

Automatic circuit breaker for trolling motor.



### Big Foot

#BFS \$24.95



**Big Foot Trolling Motor Switch**  
Two switches in one; Momentary and On/Off for all hand operated 12V or 24V Trolling Motors. Hand or foot activated On/Off lever. Protective switch cap. 32" heavy duty marine wiring.

### Breaker Cover

BCV-1 \$1.89  
Covers breaker terminals protecting them from elements and prevents corrosion.



To Order: 1-800-305-9866

Johnson® Evinrude®

	Description	\$4.99
1- 53200	Tank or Engine 5/16" Barb	
OEM 174508; Ref 18-8056; Resin; Tank or Engine 5/16" Barb; Female		



Johnson® Evinrude®

	Description	\$7.95
1-53207	Tank 1/4" NPT 2-prong	
OEM N/A; Ref 18-8063; Brass; Tank 1/4" NPT 2-prong; Male		

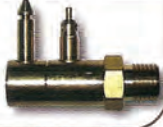

Yamaha®

	Description	\$5.99
1- 53208	Tank or Engine 3/8" Barb	
OEM 20750; Ref 18-8076; Resin; Tank 3/8" Barb; Female		



Nissan®

	Description	\$10.95
1- 53216	Tank or Engine 3/8" Barb	
Large 2.5-90 HP; OEM 3B2-70281-0; Ref 18-8079; Chrome Plated Brass; Tank or Engine 3/8" Barb; Female		



Nissan®

	Description	\$9.95
1- 53221	Tank or Engine 3/8" Barb	
OEM N/A; Ref 18-8088; Chrome Plated Brass; Tank or Engine 3/8" Barb; Female		



Suzuki®

	Description	\$10.95
1- 53197	Tank or Engine 5/16" Barb	
Large Suzuki; OEM 65750-98505; Ref 467LSF; Chrome Plated Brass; Tank or Engine 5/16" Barb; Female		



Suzuki® Honda®

	Description	\$10.95
1- 53218	Tank or Engine 3/8" Barb	
OEM 65750-95510; Ref 18-8079; Chrome Plated Brass; Tank or Engine 3/8" Barb; Female		



Honda®

	Description	\$5.99
1-53214	Engine 3/8" Barb 2-prong	
OEM 22-13563A7; Ref 18-8076; Resin; Engine 3/8" Barb 2-prong; Female		



Johnson® Evinrude®

	Description	\$4.95
1- 53206	Tank or Engine 3/8" Barb	
OEM 176445; Ref 18-8092; Resin; Tank or Engine 3/8" Barb; Female		



Yamaha®

	Description	\$5.95
1-53201	Tank or Engine 5/16" Barb	
OEM 20749/22-14213M; Ref 18-8085; Resin; Tank or Engine 5/16" Barb; Female		



Yamaha®

	Description	\$7.95
1-53209	Tank 1/4" NPT	
OEM N/A; Ref 18-8077; Brass; Tank 1/4" NPT; Male		



Nissan®

	Description	\$5.95
1- 53217	Tank 1/4" NPT	
Large 2.5-90 HP; OEM N/A; Ref 18-8078; Chrome Plated Brass; Tank 1/4" NPT; Male		



Nissan®

	Description	\$5.95
1-53220	Tank 1/4" NPT	
OEM N/A; Ref 18-8089; Chrome Plated Brass; Tank 1/4" NPT; Male		



Suzuki®

	Description	\$10.95
1-53202	Tank or Engine 5/16" Barb	
Small Suzuki; OEM 65750-98505; Ref 469SSF; Chrome Plated Brass; Tank or Engine 5/16" Barb; Female		



Suzuki® Honda®

	Description	\$5.95
1- 53219	Tank 1/4" NPT 1-prong	
Large Suzuki/Honda; OEM 99105-00193; Ref 18-8078; Chrome Plated Brass; Tank 1/4" NPT 1-prong; Female		



Honda®

	Description	\$8.99
1- 53215	Tank 3/8" NPT 2-prong	
OEM N/A; Ref 478MMC; Brass; Tank 3/8" NPT 2-prong; Male		



To Order: [www.grizzlyjig.com](http://www.grizzlyjig.com)

### Shaft Spool/Bow Roller End Cap

	Description	
7-59522	3.5" x 5/8"	3.29
7-59523	2" x 1/2"	2.99
7-59524	2.5" x 5/8"	2.99
7-59528	3" x 1/2"	2.99



Durable black rubber end cap for standard duty use.

### Bow Guard - V-Block

	Description	
1-59500	2" x 2" x 3" H x 4.5" L	3.99
1-59502	3" x 3" x 4" H x 6.5" L	6.49
1-59504	4" x 4" x 5" H x 8.5" L	12.99



Durable black rubber v-block for standard duty use.

### Bow Roller - V-Shape

	Description	
1-59506	3" Roller	3.95
7-59507	4" Roller	5.95



Durable black rubber bow roller for standard duty use.

### Bow Guard

	Description	
7-59508	4" x 1/2" Shaft	4.95
1-59509	4" x 5/8" Shaft	4.95
1-59510	5" x 1/2" Shaft	6.49
1-59512	5" x 5/8" Shaft	6.49



Durable black rubber bow guard for standard duty use. Uses 59528 end cap.

### Deep V Keel Roller

	Description	
1-59516	8" x 5/8" Shaft	14.95
1-59518	10" x 5/8" Shaft	18.95
1-59520	12" x 5/8" Shaft	21.95



Durable black rubber keel roller for standard duty use. Uses 59522 end cap.

### Straight Guide Rollers

	Description	
7-59514	9" L x 2" Dia x 1/2" Shaft	
1-59525	12" L x 2.5" Dia x 5/8" Shaft	



9" - \$8.99  
12" - \$12.99

Durable black rubber guide roller for standard duty use. 59514 uses 59523 end cap. 59525 uses 59524 end cap.

### Roller Shafts

	Description	
7-1836	1/2" x 6-1/4" - 5" Roller	2.99
7-1839	5/8" x 9-1/4" - 8" Roller	4.59
7-1840	5/8" x 11-1/8" - 10" Roller	4.99
7-1841	5/8" x 13-1/2" - 12" Roller	5.99



Zinc-plated solid steel shaft for attaching and supporting rollers. Two pal nuts and one shaft in each display package.

### Pal Nuts

	Description	
86305-1	Fits 1/2" Shaft	3.49
1-59466	Fits 5/8" Shaft	4.25



Attaches to the end of the shaft to retain roller. Packages of 8 pal nuts.

### 4-Way Trailer Wiring Harnesses

	Description	
59376	Male; 12" Long	2.99
59377	Female; 48" Long	4.99

Color-coded 4-Way wire connectors. Male trailer connector has 12" lead and female trunk connector has 48" lead.



### Trailer Wire Adapters

	Description	
59394	7-round to 4-flat	7.99
59395	7-round to 5-flat	8.49



Trailer wire connector provides a secure connection between your trailer and tow vehicle. Black plastic construction prevents rusting, enhances appearance and makes plug removal a snap.

### Anchor Locking Control

	Diameter	Length	
7-50704	1/4" - 7/16"	5-1/2'	\$9.99

Retrieve your mushroom or river anchor without getting up. Zinc plated for superior corrosion resistance. For use with up to 20 Lb anchors. Nylon wheel. Clam pack.



### Self-Centering Keel Roller

#7-1583 \$29.99

Molded grooves center boat as it moves forward for easier loading. Made from a non-marring poly blend with UV inhibitors. Replaces any 12" roller with 5/8" shaft.





### Trailer Winches

• Corrosion resistant zinc coating. • Two-way ratchet with neutral. • Winch strap with hook included. • Smooth turning grip.

<b>7-1597</b>	600 lbs., 3 to 1 Gear Ratio, 12' Strap	<b>29.95</b>	<b>1951765</b>
<b>7-1589</b>	1,000 lbs., 4 to 1 Gear Ratio, 12' Strap	<b>38.95</b>	<b>2001999</b>
<b>7-1591</b>	1,400 lbs., 4 to 1 Gear Ratio, 12' Strap	<b>41.95</b>	<b>2752132</b>
<b>7-1592</b>	1,800 lbs., 5 to 1 Gear Ratio, 2"x15' Strap	<b>48.95</b>	<b>3752932</b>



### Dual Gear Trailer Winch

• 2000 LBs maximum capacity • 4 to 1 gear ratio • Dual drive gears for uniform torque with better stability & more power • Two-way ratchet with neutral • Corrosion resistant zinc coating • 2" x 20' winch strap with hook included • Smooth turning grip

<b>7-1594</b>	Dual Gear Trailer Winch	<b>54.95</b>	<b>4753297</b>
---------------	-------------------------	--------------	----------------



### Winch Straps

	Description	Break Str.
1-59816	2" x 15' Strap	4500 Lb 10.95
1-59818	2" x 20' Strap	4500 Lb 12.95
1-59819	2" x 25' Strap	4500 Lb 15.95

Wide Polyester Webbing. Heavy duty plated safety hook. Winch straps. Cables are heavy duty.



### Spring-Loaded Bearing Protector

	Description	
1-59036	1.781" - Pair	14.95
1-59038	1.980" - Pair	16.95
1-59040	2.328" - Pair	19.95

Steel spring keeps hub grease under pressure, guarding against water seepage and failure. Grease fitting in cap.



### Spare Tire Carrier w/ Lock

	Description	
59100	w/ Lock	18.95
59103	w/ Lock Brackets	
	No Lock	10.95



Heavy 7/16" U-bolt secures tire on tongue or frame up to 3" wide. Suitable for 4 or 5 hole rims. Will fit 8" through 14" and most 15" wheels. Adjustable threaded brackets holds padlock for extra security.

### Offset Spare Tire Carrier

	Description	
59105	Offset Tire Carrier	\$29.95

Heavy duty galvanized steel construction. Fits up to 15" Tire, 4 or 5 lug. Fits Trailer Frames up to 3" wide x 4" Height. Offset 4-1/2" x 5" Rise from Frame.





# THE CRAPPIE

## CONNECTION

PODCAST WITH BRAD & JUSTIN

### Trailer Jack 1000#

- 2 Pin Swing up release
- Up to 3"x5" tongue
- 21" Lift

**\$39.95**

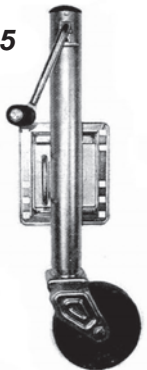

Item #7-1585

### TOUGH GUY

#### ATTWOOD Bunk Carpet



#11247-1  
12"x12 charcoal  
**\$23.95 per roll**

### Tire and Wheel Assemblies

Your boat and camper tires literally take a pounding every time you use them. Those potholes that your vehicle tires miss as you go around are usually hit by your trailer tires. Further, smaller tires don't dissipate heat as well as larger ones, so trailer and camper tires tend to heat up more, especially at high speeds. At the other extreme, they're often stored for long periods of time, which is also hard on tires. A spare tire and wheel are your best insurance that the good times will continue to roll... and roll. Choose from standard, custom spoke.



### Steel Utility Snap Hooks

Item 7653  
**\$2.<sup>95</sup>**  500#

Item 7640  
**\$4.<sup>99</sup>**  2500#

### Scissor Hooks-Steel

Item 7652  
**\$3.<sup>95</sup>**  800#



Trailer Glyde Sliks #TGS \$29.95

Designed to mount right on your carpeted bunk boards, minimizing friction and enabling you to launch and load your boat with the greatest of ease. Injection-molded design features special anti-friction and UV-inhibiting additives.

1 3/4"x17" (8 pieces)  
Color: Black

	A	B	C		
Tire Size	Lugs	Bolt Circle	Load Rng	Cntr Hole	Price
<b>A. Standard</b>					
480x8B	4	4 on 4"	B	2.5"	\$44.99
480x8B	5	5 on 4.5"	B	2.82"	\$44.99
20.5x8.0x10C	5	5 on 4.5"	C	2.82"	\$119.99
570x8"	4	4 on 4"	B	2.5"	\$66.99
570x8"	5	5 on 4.5"	B	2.82"	\$66.99
<b>B. Custom Spoke</b>					
480x12B	4	4 on 4"	B	2.82"	\$70.99
480x12B	5	5 on 4.5"	B	2.95"	\$70.99
530x12C	5	5 on 4.5"	C	2.95"	\$89.95
ST175DBC-S	5	5 on 4.5"	C	2.95"	\$98.99
<b>C. Radial Tire w/ spoke wheel</b>					
ST175/80R13C	5	5 on 4.5"	C	2.95"	\$109.95
ST205/75R14C	5	5 on 4.5"	C	3.30"	\$129.95

**Tire Pricing Subject To Change**

To Order: 1-800-305-9866

**SWIVL-EZE**  
Camo 3 Pc Pedestal Set



97749C-11"  
\$79.99  
97750C-13"  
\$82.99  
97751C-16"  
\$89.99

- Seat Mt
- 3/4" Pin Post
- 7x7 Base Plate
- ABYC-B
- Corrosive Resistant
- Shock Absorbing Spring
- Max-4 Camo
- 360° Swivel

**MAX-4 CAMO**

**\$119.<sup>99</sup>**

- Complete with two 7x7 3/4" galvanized bases.
- Do not occupy seats with speeds over 5 mph.
- Portable seat for tailgating.

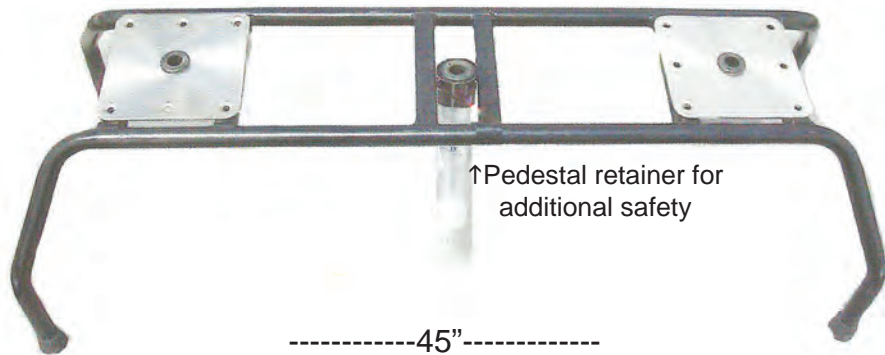

**GRIZCO PRO**  
**DOUBLE SEAT STAND** By Wise

Slides over 1.77" or less

↑Pedestal retainer for additional safety

-----45"-----  
13"H x 18"D x 45" W

**Special Buy**  
**\$12.95**



11" Polished Aluminum 3/4" Pedestal Threaded  
#SP-11-T

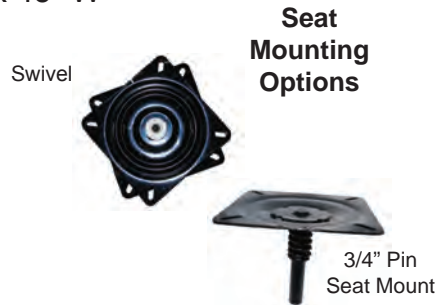

**WALTON'S**  
**KWIK MART**

Chris Walton, Owner

**OPEN 7 DAYS A WEEK 4:30 A.M. - 11:00 P.M.**

**Live Bait • Fishing Tackle**  
**Fishing Supplies • Gas**  
**Only Diesel in Town**

**5601 W. HWY 22**  
**SAMBURG, TN 38254**  
**731-538-2711**

MINNOWS...COFFEE...HOT WINDOW...DELI...  
BAR-B-QUE...PIZZA...BEER...TN LOTTO

To Order: [www.grizzlyjig.com](http://www.grizzlyjig.com)



**9" Round Seat Mounts**



**\$31.95**

SP-68914

**2 3/8" Power Pedestal with Seat Mount**

SP37904  
13" to 19"  
\$99.99

SP37914  
24" to 30"  
\$104.95



SP-37904

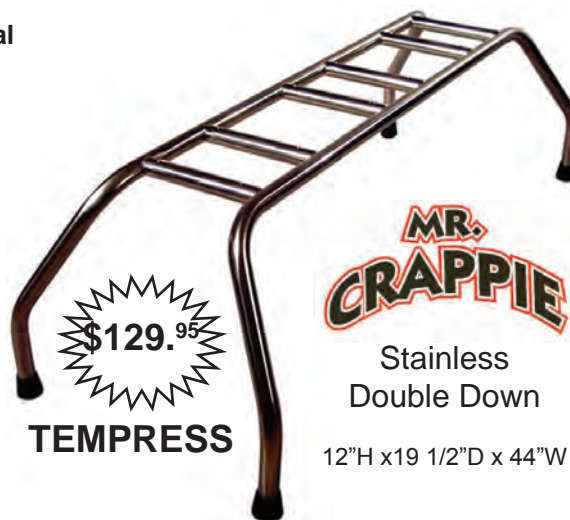

**MR. CRAPPIE**

Stainless  
Double Down

12"H x 19 1/2"D x 44"W

**\$129.95**

**TEMPRESS**

**2" Fixed Pedestal**



SP28911  
11" \$26.95

SP28913  
13" \$27.95



**\$39.95**

SP18914

Seat Mount 3° Tilt

**SINGLE #8WD1234 \$39.95**



13"H - 18"D - 19"W

**Hunter Special CAMO COMBO**

**#1234-COMBO \$79.95**



Swivel included.

**Crappie Fisherman Special DOUBLE SEAT STAND**

• Takes standard swivel or 7x7 floor base to adapt 3/4" pin seat mount.

**#8WD1280 \$79.95**

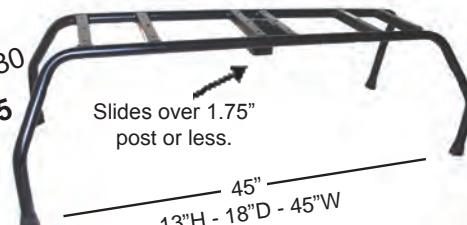

Slides over 1.75" post or less.

45"  
13"H - 18"D - 45"W

#139CLS-G732  
Mossy Oak Breakup

Green  
Plastic Frame

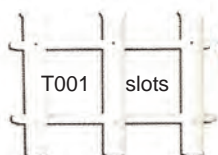

**3 Rod Holder 52214-3 \$22.99**



**2 Rod Holder 52212 \$17.99**

**4 Rod Holder 52214-4 \$26.99**

**WD-2016-Z \$54.99**  
**WD-2016-SS \$68.99**  
• Brushed Aluminum 16" Post  
• 7" Zinc or Stainless Base  
• 360° Seat Mount w/ Spring

**WD-2016-Z 16" Pedestal Set for the Longer Legged Man**  
Zinc Plated Base  
**WD-2016-SS**  
Stainless Steel Base

**Swivl-Eze #90720 \$21.95**  
**7" FIXED HEIGHT PEDESTAL**

• Black, powder coated steel

**Swivl-Eze #91320 \$23.95**  
**13" FIXED HEIGHT PEDESTAL**

• Black, powder coated steel

**SWIVL-EZE #91320-ADJ \$32.95**  
**ADJUSTABLE HEIGHT PEDESTAL**

• Adjusts from 12" to 18"  
• Black, powder coated steel



WD-2014

**SWIVL-EZE**



**7" 90720**  
**13" 91320**

**SWIVL-EZE**



**91320-ADJ**

**To Order: 1-800-305-9866**



*Jon Boat Clamp with Swivel* **ACTION**

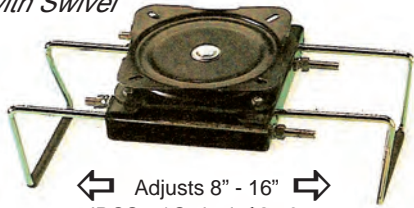

← Adjusts 8" - 16" →  
 JBCLS w/ Swivel \$24.95  
 JBCLS NO Swivel *Special Price* \$14.99

**SLIDING SEAT MOUNTS**

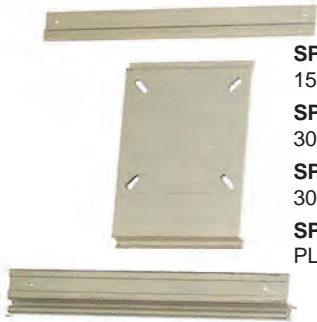

**SP-15900**  
 15" KIT \$45.95  
**SP-15300**  
 30" KIT \$48.95  
**SP-15200**  
 30" SLIDES \$27.95  
**SP-15100**  
 PLATE ONLY \$21.95

**LakeSport 2-3/8" Bell Pedestals**

238913LSM1  
 13" \$64.99  
 238916LSM1  
 16" \$69.99



\$87.95

Fixed Height Set With Seat Mount

Adjustable Height Set With Seat Mount - Friction Lock  
 2385400 14" - 20"

**Transom Saver Types**

B Bolt on Bracket



23" - 35"

R Roller Bracket



Deluxe Head. Adjustable Length. Bolt-On Bracket and Roller Bracket  
**SP-400-RB**  
**\$39.99**

24" - 36"



Pro Adjustable Head. Adjustable length. Roller Bracket & Bolt-On Bracket  
**SP-400-ADJ-R-B**  
**\$54.95**

**NEW**  
**SP-424-ADJ-RB**  
 32"-44"  
**\$57.99**



Includes Shock Absorbing Spring

Shock-Eze Pro Adjustable Head. Adjustable Length. Roller Bracket  
**SP-421-RB**  
 27" - 36"  
**\$74.99**  
**SP-429-RB**  
 29" - 39"  
**\$79.99**

**Snap-Lock 1.77" Posts**

Fixed Height



**SP29130- 13"**  
**\$29.95**

Adjustable Height Power Pedestal



SLP  
 39004- 16-20"  
**\$89.95**  
 39204- 24-30"  
**\$94.95**

**1.77" Seat Mount**



**SP19000**  
**\$31.95**

**1.77" Base Plate**



**69773-SS**  
**\$45.95**

**SEAT MOUNT**

Cast Aluminum Friction Control

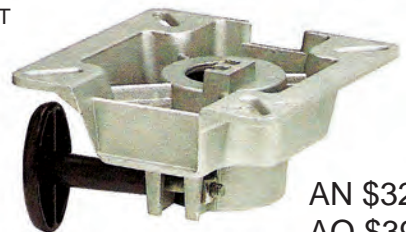

**AN \$32.95**  
**AO \$39.95**

**SP-001003430**  
**REPLACEMENT BUSHING**  
**\$8.99**

**#818440-AN** Above  
**#818441-AO** For Driver's Seat with Locking Lever

To Order: [www.grizzlyjig.com](http://www.grizzlyjig.com)





**ALUMINUM POST**



ITEM	HT	PRICE
AP2064	6"	14.95
AP2114	11"	14.95
AP2134	13"	16.95
AP2164	16"	18.95
AP2244	24"	28.95

Add "T" for threaded & \$1.00.

**Made in USA**

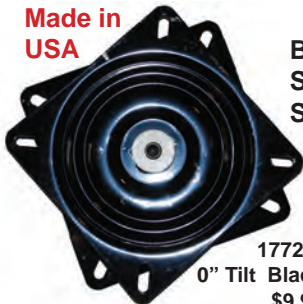

**Ball Bearing SEAT SWIVEL**

1772-F 0" Tilt Black \$9.99  
Need more room to maneuver? The 6" Swivl-Eze offset allows additional seat clearance in any position 7062-3

**Swivl-Offset**



\$39.95



**3/4-177 Adapter SP-14000 #17.95**



**#201 \$4.95 White Nylon Bushing for Post 3/4" ID**



**#30006 \$8.95 Bronze Bushing for 3/4" Bases**



Adjustable Power Pedestal With Integral Seat Mount  
3004 14" - 19" HT \$85.99  
3204 24" - 30" HT \$91.99



Adjustable Power Pedestal For Use With 3/4" Pin Seat Mounts  
3004-R 15" - 18" HT \$89.99  
3204-R 24" - 30" HT \$96.99

\$14.95

**Powder Coated Steel With Spring 1002-WS**



**STAINLESS**

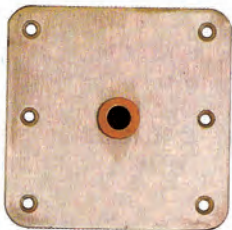

**\$36.95 #SS67739 7"X 7"**

**STAINLESS**

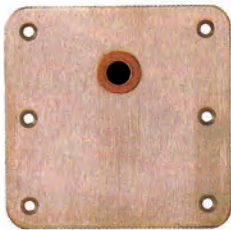

**\$38.95 #SS67739-SC 7"X 7"**

**STAINLESS**



**\$28.99 #64839 4"X 8"**



Allows 6" of Additional Leg Room!  
Stainless Steel Offset Post Threaded  
7153-T-SS \$79.95



Pro Post Adjustable Height  
2244-ADJ-T \$49.99

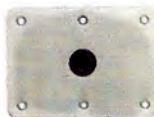

Stainless Steel 6"X 8" SS66839

\$31.99

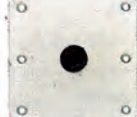

Zinc Plated Steel 7"X 7" ZS67729

\$22.95

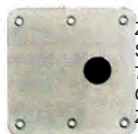

Zinc Plated Steel 7"X 7" Offset Hole ZS67729-SC

\$25.95

ZINC ZS6682 6"x8" \$19.99

**Close Out Pedestals Action Products Made in the U.S.A.**



#5467 \$13.99



#5452 \$15.99



ITEM PS937729-Z 3 PC 11" PEDESTAL SET ZINC PLATED BASE \$49.99



ITEM PS937739-S 3 PC 11" PEDESTAL SET W/ STAINLESS BASE \$58.99

\*For different post lengths, calculate the difference in post price.

To Order: 1-800-305-9866

# TEMPRESS NaviStyle

Low Back  
&  
Hi Back

Blue/Gray



#54672-Low \$112.95  
#54901-Hi \$122.95

Charcoal



#54675-Low \$112.95  
#54907-Hi \$122.95

Red/Gray



#54683 - Low \$112.95  
#54911 - Hi \$122.95

Mossy Oak  
Break Up



#54755 - Low \$126.95  
#54921 - Hi \$144.95

## ELITE High Back Helm Seats



#57017  
Charcoal/Gray  
\$225.95

#57010  
White/White  
\$225.95

#57018  
Mossy Oak  
Break Up  
(new vinyl)  
\$245.95



Mossy Oak  
Shadowgrass



#54756 - Low \$126.95  
#54922 - Hi \$144.95

Tan/Sand



#54684-Low \$112.95  
#54919-Hi \$122.95

White/Blue



#54678 - \$112.95  
Low Back ONLY

White



#54681 - \$112.95  
Low Back ONLY

3373

**AERO X COOL RIDE SEAT**

H: 23" W: 19.75" D: 28.5"  
 - Sitting Depth: 18"  
 3373-1800 Carbon Grey

**NEW ITEM**

**\$174.99**



**Aero X**  
 COOL-RIDE BOAT SEAT

- BREATHABLE MESH FABRIC SITTING SURFACE
- NO-PINCH HINGE SYSTEM • REPLACES RESTRICTIVE SUPPORT STRAPS
- AIRCRAFT GRADE ALUMINUM CONSTRUCTION W/ POWDER COATED FINISH
- ACCESSORIZE WITH GEAR HOLDING EXPANSION SLOTS
- INCLUDES STAINLESS STEEL MOUNTING HARDWARE
- UV TREATED AND MOLD / MILDEW RESISTANT
- MOUNTS TO ANY MARINE PEDESTAL WITH A 5 1/4" HOLE PATTERN
- 3 YEAR WARRANTY



Let us give you a price quote on your pontoon furniture.....back to back lounges, jump seats, bucket seats, and pro angler buckets. We also have seats for your pontoon, ski boat, cruiser, runabout, and crappie boat. Go to [www.wiseseats.com](http://www.wiseseats.com) and pick out your seat style, part number, and color then give us a call.



Pontoon Furniture Sets

Deluxe Series



Give us a call!  
 1-800-305-9866



### Fishing Boat Seats Injected Molded Plastic Frame

#### FEATURES

- State-of-the-Art, High-Impact Plastic Frames
- Compression Foam Padding
- Heavy-Duty 28 oz. Marine Grade Vinyl
- Mildew Resistant & UV Treated
- No-Pinch Aluminum Hinges
- **5 Year Warranty on Frame**
- **3 Year Warranty on Upholstery**



**\$89.99 ea**

**DEM No-Pinch Hinge**



#### 8WD640PLS PREMIUM HIGH BACK

Height: 22.5" Width: 17" Depth: 19.75"  
Seat Depth: 16"

**\$64.99 ea**

#### 8WD588PLS MID BACK

- No Pinch hinge
- Height: 21.25" Width: 17" Depth: 21"  
Seat Depth: 14"



8WD588PLS

**\$48.99 ea**

#### 8WD734PLS PROMOTIONAL LOW BACK

Height: 19" Width: 16" Depth: 18.5"  
Seat Depth: 14"  
Available in All Colors Shown w/ 781PLS



8WD734PLS



#### ARM RESTS

- Heavy Duty Anodized Aluminum Arm Support Brackets
- Compression Foam Padding Covered in 28 oz. Marine Grade Vinyl
- Fits Wise Mid Back, High Back Seats
- Mounting Hardware Included
- 3 Year Warranty

H: 12" W: 2.5" D: 9.5"  
8WD444AR-710 White  
8WD444AR-715 Sand  
8WD444AR-717 Grey



Mounted to  
8WD444AR



To Order: [www.grizzlyjig.com](http://www.grizzlyjig.com)



# CAMO SEATING

BOAT SEATS AND MOUNTS

## 8WD139CLS

### CAMO PADDED FOLD DOWN

Height: 15.75" Width: 20.25" Depth: 19.75"  
-Sitting Depth: 15.5"

#### Features

- COMPATIBLE w/ WISE SEAT CADDY
- 3 YEAR WARRANTY ON FRAME

8WD139CLS-B-728 SG Blades/Brown Shell

8WD139CLS-B-730 Bottomland/Brown Shell

8WD139CLS-B-733 Max 5/Brown Shell

8WD139CLS-G-762 APG/Green Shell



\$52.99 ea

B-728

B-730

B-733

2WD139CLS-G-762

## 8WD308

### 48" CAMO BENCH SEAT FOLD DOWN

Height: 23.5" Width: 49" Depth: 23.5"  
Seat Depth: 17"

- |                                     |          |
|-------------------------------------|----------|
| Available: 730 Mossy Oak Bottomland | \$229.99 |
| 733 Realtree Max 5 (Cordura)        | \$229.99 |
| 1736 Mossy Oak Shadow Grass (Vinyl) | \$199.99 |
| 1739 Realtree Max 5 (Vinyl)         | \$199.99 |
| 763 Break Up (Cordura)              | \$199.99 |

## 8WD309

### 42" CAMO BENCH SEAT FOLD DOWN

Height: 21" Width: 43" Depth: 19"  
Seat Depth: 14.5"

- |                                      |          |
|--------------------------------------|----------|
| Available: 730 Mossy Oak Bottomland  | \$229.99 |
| 729 Mossy Oak Shadow Grass (Cordura) | \$189.99 |
| 733 Realtree Max 5 (Cordura)         | \$229.99 |
| 1737 Break Up (Vinyl)                | \$189.99 |
| 1739 Realtree Max 5 (Vinyl)          | \$189.99 |



8WD309-1739

## 8WD617PLS

### CAMO HIGH BACK

Height: 22" Width: 16.5" Depth: 18.5"  
-Sitting Depth: 14.5"

#### Features

- ALUMINUM NO-PINCH HINGES
- 8WD617PLS-728 Shadowgrass Blades
- 8WD617PLS-730 Original Bottomland
- 8WD617PLS-731 Break Up Country
- 8WD617PLS-733 Max 5

\$74.99

## 8WD618PLS

### CAMO LOW BACK

Height: 18.75" Width: 16" Depth: 18.5"  
-Sitting Depth: 14"

#### Features

- ALUMINUM NO-PINCH HINGES
- 8WD618PLS-728 Shadowgrass Blades
- 8WD618PLS-730 Original Bottomland
- 8WD618PLS-731 Break Up Country
- 8WD618PLS-733 Max 5

\$59.99



8WD618PLS-728

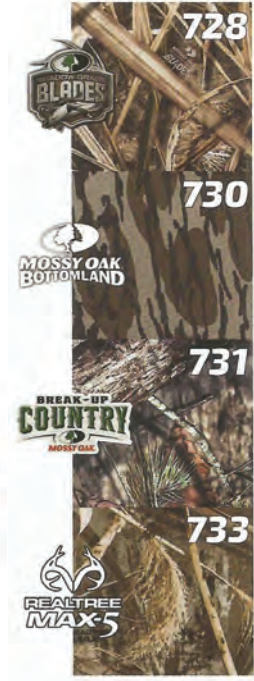

To Order: 1-800-305-9866



#B-100-GY



#B-100-GN

**B Series**

**FEATURES**

- All day comfort
- ComfortMAX contoured, tight sling
- Breathable cool fabric
- UV resistant to sun and elements
- All aluminum construction
- Mold and mildew resistant
- Mounts to any boat seat pedestal
- 1 year warranty

**B100**

**\$99.99**

**SPECIFICATIONS**

- Material – Aluminum
- Capacity – 400 lbs.
- Weight – 11 lbs.
- Seat Size – 22" L | 21" W | 10" H

#B-200-GY



#B-200-GN

**B200 \$79.99**

**SPECIFICATIONS**

- Material – Aluminum
- Capacity – 400 lbs.
- Weight – 7 lbs
- Seat Size – 21" L | 18" W | 7" H

**B300**

**\$89.99**

**SPECIFICATIONS**

- Material – Aluminum
- Capacity – 400 lbs.
- Weight – 7 lbs
- Seat Size – 21" L | 13" W | 7" H



#B-300-GY

**PRO-M Series**

**FEATURES**

- All day comfort
- ComfortMAX contoured, tight sling seat
- Breathable cool fabric
- UV resistant to sun and elements
- Anodized aluminum construction
- Mold and mildew resistant
- Mounts to any boat seat pedestal
- Will hold up to all salt water elements
- 1 year warranty



#B-300-GN



#P-100-WH

#P-100-GY

**PRO-M100 \$141.99**

**SPECIFICATIONS**

- Material Anodized Aluminum
- Capacity 400 lbs.
- Weight 13 lbs.
- Seat Size: 22" L | 21" W | 10" H

**PRO-M200**

**SPECIFICATIONS**

- Material Anodized Aluminum
- Capacity 400 lbs.
- Weight 8 lbs.
- Seat Size W 20" D 17"
- Seat Height 17" – 20"



#P-200-GY

#P-200-WH

**\$95.99**

#P-300-GY



#P-300-WH

**PRO-M300 \$95.99**

**SPECIFICATIONS**

- Material: Aluminum
- Capacity: 400 lbs.
- Weight: 8 lbs.
- Size: 21" L | 14" W | 7" H

**Side Kick Fishing Double Seat**

**\$269.99**

- Will accept any seat with industry standard four hole bolt pattern
- No-skid feet for both carpet and gel coat
- Fits any 3/4" pin/screw-in type receptacle
- Fully adjustable for height and width
- 17 inches of horizontal adjustments
- Pivoting center
- Seat pedestals are height adjustable
- Material: Anodized aluminum
- 1 year warranty

#D200



**SPECIFICATIONS**

- Material: Anodized Aluminum
- Seat Size: 23" L | 7.5" W | 7.5" H



**Shade Tree Umbrella #U570**

**\$109.99**

- Height: 47.5
- Width: 6
- Depth: 5

\*Stand and seats shown for demonstration purposes only and not included



**Shade Tree Umbrella Holder #U571 \$52.99**

**SPECIFICATIONS**

- Material: Anodized Aluminum
- Size: 16" L | 7" W | 2.5" H

\*Umbrella and seats shown for demonstration purposes only and not included

To Order: [www.grizzlyjig.com](http://www.grizzlyjig.com)



**\$149.99**

**SPYDERLOK GEN 2  
R-100**

**SPECIFICATIONS**

- Material – Anodized Aluminum
- Size – 12" to 20"
- Easily accommodates 4 rod heads
- 1 year warranty

**\$95.99**

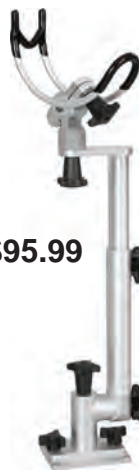

**SINGLE SPYDERLOK  
R-200**

- All anodized aluminum construction
- Great for salt or fresh water
- Smooth and easy pole angle adjustment
- Easy two knob removal
- Mounting plate is flush with carpet – No more stubbed toes

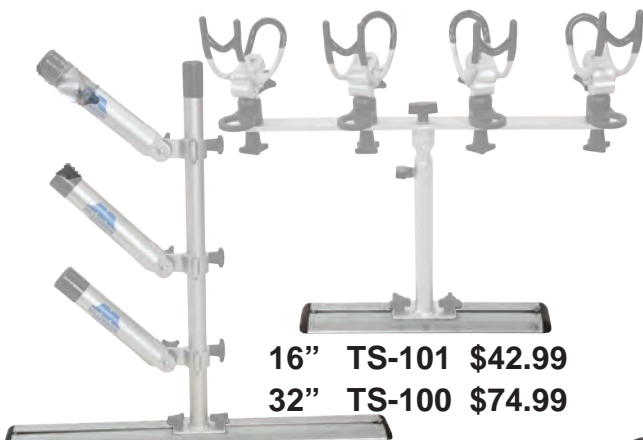

**16" TS-101 \$42.99**  
**32" TS-100 \$74.99**

**SPYDERLOK ROD TREE  
R-400**

**\$212.99**

**SPECIFICATIONS**

- All anodized aluminum construction, low glare finish
- Easy two knob removal
- Mounts with either the R-101 or TS series track system
- Useful ridge in rod holder bottom to prevent rod turning
- Stainless steel hardware
- Durable rubber boot to protect rod handle
- Size: 31"L / 6.5"W / 2.5"H
- 1 year warranty



**SPYDERLOK TRACK SYSTEM**

**SPECIFICATIONS**

- Anodized aircraft aluminum construction, low glare finish
- Includes stainless steel hardware
- For use with all Spyderlok products, including: R-100, R-400, R-401, R-200, R-300
- Available in 32" and 16" length
- Includes easily removed plastic end caps
- Include one R-110 track system mount
- Can be mounted on the gunnels or deck
- 1 year warranty

**SPYDERLOK ROD POD  
R-401**

**SPECIFICATIONS**

- All anodized aluminum construction, low glare finish
- Easy two knob removal
- Mounts with either the R-101 or TS series track system
- Useful ridge in rod holder bottom to prevent rod turning
- Stainless steel hardware
- Durable rubber boot to protect rod handle
- Size: 14.5"L / 6.5"W / 2.5"H
- 1 year warranty

**\$95.99**



**RAPID ROD TRANSPORT  
R-102**

**SPECIFICATIONS**

- Keeps your rod upright with ease while in transport
- Material - Composite
- Made specifically for the SpyderLock System
- Easy removal
- SIZE - 4.5" x 9" x 1"
- 1-year warranty

**\$31.99**

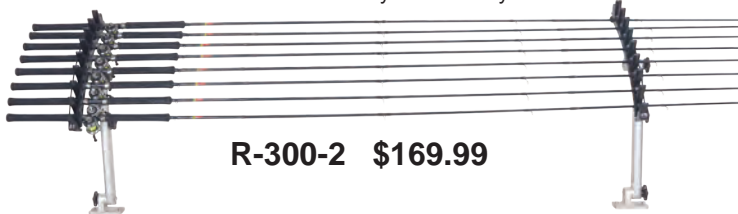

**R-300-2 \$169.99**

**RAPID ROD TRANSPORT RACKS**

**SPECIFICATIONS**

- Transport up to eight rods at one time with ease and convenience
- Material: Anodized Aluminum
- Size: 10" x 18.5" x 4.5"
- Gross: Wt. 11.5 lb
- Net Wt.: 11 lb
- Available in single, double, or triple (This is the number of aluminum rod stands.)
- 1-year warranty



**R-300-1 \$84.99**



**R-300-3 \$249.99**

**To Order: 1-800-305-9866**

DEPENDABLE



# Rod Holders - Trolling Systems

3rd Section Available (May be needed for 1' or longer.)



TS-2150-4" \$61.99  
TS-2150-8" \$69.99



TS-2160-4" \$61.99  
TS-2160-8" \$69.99  
Offset Tip Saver

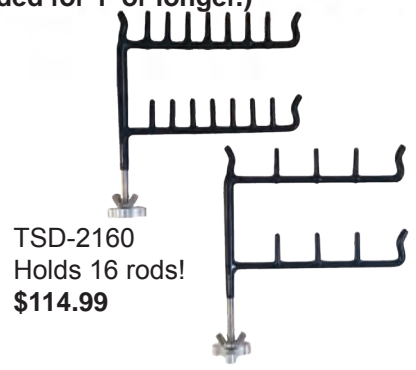

TSD-2160  
Holds 16 rods!  
\$114.99

## T-500 TROLL MASTER

Best for mounting to the deck  
Patent #7 640 692 B1

T-5100-4' \$146.99  
T-5100-8' \$179.99  
Clamps to top bar for easy mounting. Also offsets top bar from vertical stems; either inward or outward.  
1" Diameter, 16 Ga. Stainless

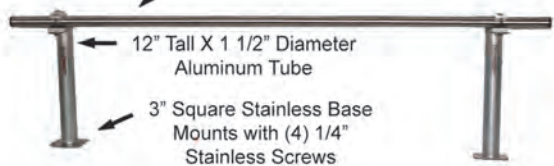

Kent Driscoll trolling with a T-5100-4

Mount flush bases permanently to boat and the rack can be attached and remove in seconds. Available from 2 to 8 feet long - last digit of part # indicates the length in feet (2 foot version pictured). Rods can be adjusted to any angle vertically and side to side. Use with 205-B Pro 1" round rail clamp bases and Pro rod holders OR 215-B Li'l Pro 1" round rail clamp bases and Li'l Pro rod holders sold separately.

## The T-250-HMR Trolling System Metallic Red

\$145.99



Includes:  
(4) 210-H  
Li'l Pro  
Rod Holders

T-250-H MR equipped with Li'l Pro rod holders is designed for spider rigging (slow trolling jigs or minnows). The Li'l Pro rod holders offer the versatility of side trolling as well because of the "U" shaped front.

## Crow Foot

### Pedestal Mount

Mounts (2) T-250 systems on a bass boat with no drilling!  
For 3/4" seat pins.  
Also available for Ranger pins

T-250-P  
Regular 3/4"  
\$369.99  
T-250-R  
Ranger (1.77")  
\$389.99



Any Driftmaster products we do not stock, we will drop ship from the factory.



DEPENDABLE



# Rod Holders - Trolling Systems

LIFETIME GUARANTEE AGAINST BREAKAGE  
SOLID STEEL CONSTRUCTION EASILY REMOVED FOR STORAGE  
PROTECTIVE COATING HOLDS ANY KIND OF ROD OR POLE

210-H **Li'l Pro Series** -  
The Right Rod Holder  
For The Way You Fish.

\$15.99 ea

LI'L PRO

3/8" Spare  
Base  
210-B  
\$6.29



10" Tall X 1/2"

1/2"  
200-B Star Base  
(included)

Spare Base  
\$6.99

**T-118-H**  
4 Rod System  
\$119.95



Round Rail Clamp Base  
Li'l Pro 214B 7/8"  
Li'l Pro 215B 1"  
\$8.99 ea

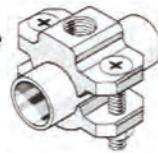

Gun Slinger



\$15.99 ea

Gun Slinger 2100-HC

Designed with Crappie fishing champion Ronnie Capps specifically for spider rigging. "V" shape front allows hook sets to the right or left. Wider cradle has special shape to allow unimpeded hand access for faster hook sets.



\$15.99

#600

Rod Rester



Holds rod vertically while moving.  
Attaches to stem of rod holder.

The **T-250** T-Bar Offers Superior Strength, Easy Adjustment, and Quick Disassembly. Available with "Li'l Pro" Or "Gun Slinger" Rod Holders

Remove Wing Nut To Disassemble  
For Easy Storage. \$139.95



**T-250-H**

\$139.95

**Includes:**  
stainless mounting base  
(4) 210-H Li'l Pro Rod Holders  
(4) 214-B clamp bases  
Spare Mounting Base  
250-B  
\$12.95

18" Tall X 1 1/2" Diameter  
Aluminum Tube

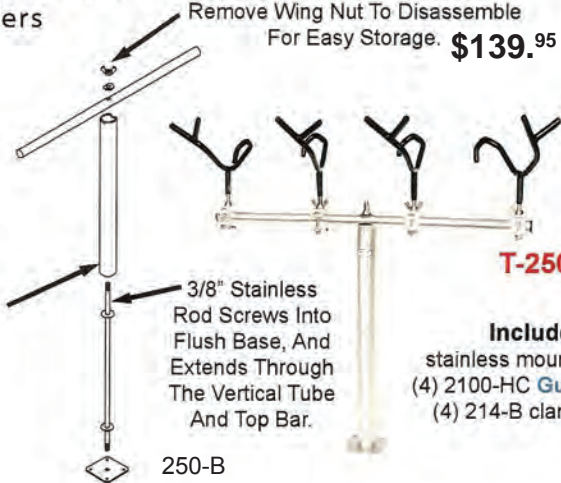

**T-250-HC**

**Includes:**  
stainless mounting base  
(4) 2100-HC Gun Slingers  
(4) 214-B clamp bases

250-B

To Order: 1-800-305-9866

ROD HOLDERS

DEPENDABLE



# Rod Holders - Trolling Systems

7/8" Diameter Aluminum Tube  
214-B Li'l Pro Bases Included



Lock Sprocket  
Locks T-Bar  
Left to Right

**Round Trolling Bars**  
Offer Side To Side Ad-  
justment And **Unlimited**  
**Rod Angle Adjustment**

\$79.<sup>95</sup>

**Lean Green Rod Holder**  
#100-H



\$9.<sup>95</sup>

- 25° Rod Angle
- 3/8" Threaded Stem

**FT-18-H**  
Flat T-Bar System  
4 Rod System



1 1/2" X 3/8"  
Aluminum Bar

\$89.<sup>95</sup>

10" Tall X 1/2"  
Diameter Plated  
Stem Mounts To  
200-B Star Base  
(included)

**Flat Trolling Bars**  
Offer Side To Side  
Adjustment, With A  
**Fixed Rod Angle**

## CATFISH - BIG WATER HOLDERS



\$142.<sup>95</sup>

**T-500-H**  
**BIG FISH T-BAR**  
Patent #7 640 692 B1

12" Tall X 16" Wide  
Equipped with 2 Pro  
*Duo* Rod Holders.  
Features 1" top bar  
with locking pins to  
prevent rail clamps  
from slipping.

**255-H-1/2**

Adjustable rod holders only  
give you two usable positions.

The *Duo* offers two practical  
rod angles with no  
moving parts or  
teeth to strip.  
Holds rod at 0°  
with handle in  
top rear loop, 30°  
with handle in bottom.  
Closed rear loop for  
extra security. Comes  
standard with stainless  
stem and wing nut.



\$26.<sup>95</sup>

**200-H-1/2**  
**PRO Series**

→ | 1 3/4 | ←

\$21.<sup>95</sup>



1/2"  
threaded stem

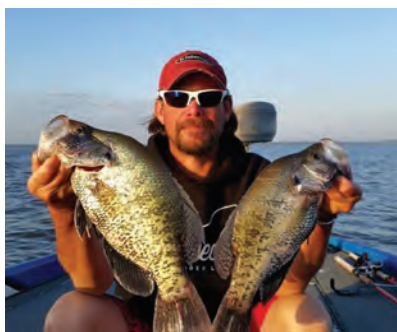

Crappie Pro  
and Guide on  
Lake Eufaula, OK

*Specializing in  
Crappie  
and Small Mouth*

**Todd Huckabee**

Phone: 405-520-8980

**BALZOUT**  
LLC.COM

**SRM-RB-6" \$179.00**

**SRM-RB-12" \$189.00**

The new alternative  
for mounting your  
Humminbird/Low-  
rance depthfinders.



# GRIFFIN

Custom Pole Holders  
Adjust 12" to 24"



Oversize Shipping



## "Sure Grip" Bases for all 3/8" Holders



Flat Rail #5072-7



V Round #5073-3



Side Mount  
#5070-3



Flush  
Star  
#5071-3

**All Bases \$5.79**



7/8" Clamp On  
Rail Base  
#5074-3 \$8.49

### 3 pc Removable Holder

- G3pc-3 Rod - -\$58.95
- G3pc-4 Rod - -\$62.95
- G3pc-5 Rod - -\$64.95
- G3pc-6 Rod - -\$68.95
- G3pc-8 Rod - -\$79.95

### Pedestal Mount For Standard 1-1/2" Post

- GPM-3 Rod - -\$67.95
- GPM-4 Rod - -\$71.95
- GPM-5 Rod - -\$73.95
- GPM-6 Rod - -\$76.95
- GPM-8 Rod - -\$85.95

*Pedestal Mount slips over your seat pedestal.  
Easy on - Easy off  
(can special order 2" for Ranger 1.77 post)*



### "Sure Grip" Steel Rod Holders with Stainless Steel Stems and Wing Nuts



**\$13.95**

- 5060-3 5° Base Included
- 5062-3 25° Base Included
- 5063-3 45° Base Included



**\$14.95**

5061-3 Base Included

### Rod Storage Holder

Holds up to 3 fishing rods.



**\$13.95**

Black 12750-6  
8 3/4" L x 2 1/2" W

Mounts vertical or horizontal.

# ROD SAFE

**\$259.95**

- Lock, secure, transport up to 8 rods
- Comes with keyed lock
- Locking base
- 2 support bars





**Capps & Coleman  
Pro Series Widow Maker  
By: Titelok**



Designed by 8 Time National Crappie Champions

BLACK

#RH-CAPPS-5610  
w/ 4.5" Base  
**\$79.95 each**

**Bottom Welded On**

#RH-CAPPS-5610BLK  
**\$79.95**

Holds your pole in a single rod holder allowing no interruptions to the other lines.

**Crappie Stalkers**



Single pole spider rigging system isolates rods for more detailed strikes.

**T-275-HC**  
Gun Slinger Style

**T-275-HCX**  
Offset Style

**Your Choice**

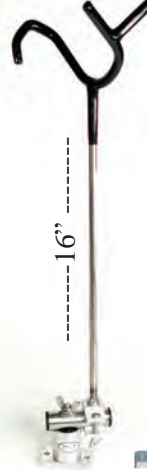

16"



6"

#T-275-HC \$69.99  
#T-275-HCX \$81.99

Set of 8  
#T-275-HC-8 \$520.00  
#T-275-HCX-8 \$620.00

Unlimited Adjustment



**LAKEVIEW**



**Dining Room**



Dottie with a basket of her homemade rolls. (These rolls alone will keep you coming back.)

From the ruins of a devastating fire on Sept. 11, 1998, JD and Dottie Dowing began plans for the restaurant visitors see today.

An interesting menu printed as a newspaper you can read about Reelfoot history and upcoming special events such as the Arts and Crafts Festival in the fall, while you wait to dine on anything from appetizers of fried green tomatoes to entrees of steak or shrimp. An extensive menu to include the old-time tradition of meals served family-style. Platters with fresh piping hot fish, country ham, tempra breaded chicken, tenderloin and quail. Joined with red-eye gravy, twice-baked potatoes, country-style butter apples and melt-in-you-mouth onion rings. Accompanying your meal are hush puppies and their homemade rolls. Reelfoot traditional dining at its finest.

From breakfast, lunch or dinner dine on southern cooking at its best, a tradition more than a half century old.

**Dottie & J.D. Downing, Owner**

**3550 State Rt. 21 E  
Tiptonville, TN 38079  
731-253-7516**



*Private Dining Available for Large or Small Groups*

*Tour Bus Groups Welcome*

*Open 7 Days A Week*

**To Order: [www.grizzlyjig.com](http://www.grizzlyjig.com)**



\$129.99

**5760-610-4 Deck Mount**  
(5760 Mount w/5610 Rod Holders)  
Mounts 3 or 4 rod holders.  
Easily removed for storage.  
Allows 360° rotation of each individual rod holder.

**PL5760/1 Base**  
Fits only 5760 rack.  
**\$12.95**

**Pin-Lok Washer**



HP-5600-1 \$2.29  
HP-5600-4PK \$8.99

**Large T Handle for 5610 Holders**



HP-5610-1 \$1.99  
HP-5610-4PK \$6.99



\$119.99

**5840-610-4 Black Widow Ultra**  
Mounts 4 rods. (2" heavy duty tube, 16" top bar. Comes with 4 1/2" mounting track.)

**Spare Mounting Track**  
#5901-4.5" \$13.99  
#5901-12" \$20.99  
#5901-18" \$27.99  
#5901-24" \$31.99

**Stow Away System**

The Tite-Lok Stow Away System comes assembled and ready to use. Place the system in the existing seat pedestal.

Unfold and attach the safety strap to the boat cleats. Tighten to hold the system in place.

Set rod holders in upright position then loosen screws to set the desired angle for the rod holder. Tighten screws. Now you're ready to start trolling.



\$199.95

**5940-620**  
Comes with four 5620 Sure Set Rod Holders.



\$129.99

**5841-610-4 Supreme Black Widow**  
Mounts 4 rods. (2" heavy duty tube, 24" top bar. Comes with 4 1/2" mounting track.)

#5901-4.5 Spare Mounting Track  
**\$13.99**



**RH5610 Rod Holder Series**

\$19.95

**5610 Rod Holder**  
Our patented open style rod holder rotates to 12 locking positions and tilts to desired fishing rod angle. Attach to any Tite-Lok Mount.

**We Proudly Sponsor...**



To Order: 1-800-305-9866

## Shore King 5 Rod Holder



**Part No. TRH-100**  
**\$16.95**

Holds Up to 5 Rods At One Time

Single Rod

Height Adjusts from 20" to 43" High  
Aluminum - 1/2" Dia.

- Folds for Easy Storage
- Deluxe E-Z Lock Legs

20"-43"  
**BS-200**  
**\$3.99**

## Rod Holder with Surface Mount



**#7-52079**  
**\$8.99 ea.**

**#1-52079**  
**\$47.95**  
**6 pk**

- Corrosion Resistant
- PVC Coated
- Easy to Mount
- Base Included

## GRIZCO Heavy Duty Rod Holder



- Easy adjust up and down & side to side
- Full 2" clamp
- Painted steel with insulated pole rest

Item	Price
04100-003	\$4.89 ea
04100-003-3	\$12.95/3 pk

## Shore King Bank Rod Holder



**\$4.99**

Heavy Duty/  
X-Long  
**Part No. WBH-4**  
1/4" Dia. Wire  
Powder Coated White  
Color

- Glow-In-The-Dark Hi-Viz Top
- E-Z Push-In "Foot Pedal"

## GRIZCO Bolt On Rod Holder

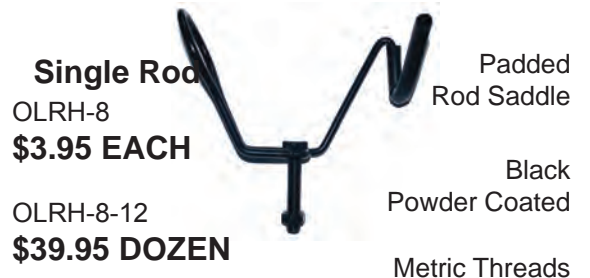

**Single Rod** Padded Rod Saddle  
OLRH-8  
**\$3.95 EACH**

**Black Powder Coated**  
OLRH-8-12  
**\$39.95 DOZEN**

Metric Threads

**Build your own rod rack!**

## Boat Rod Holder

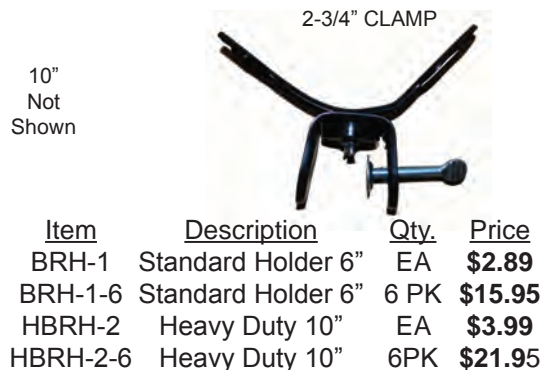

2-3/4" CLAMP

10" Not Shown

Item	Description	Qty.	Price
BRH-1	Standard Holder 6"	EA	\$2.89
BRH-1-6	Standard Holder 6"	6 PK	\$15.95
HBRH-2	Heavy Duty 10"	EA	\$3.99
HBRH-2-6	Heavy Duty 10"	6PK	\$21.95

## Shore King Boat Rod Holder

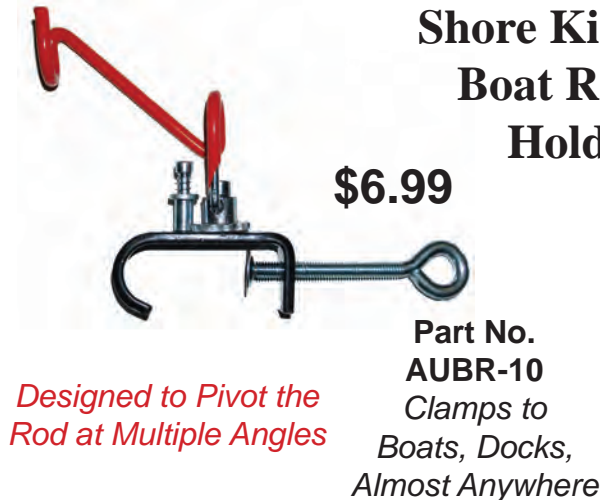

**\$6.99**

**Part No. AUBR-10**  
Clamps to Boats, Docks, Almost Anywhere

*Designed to Pivot the Rod at Multiple Angles*

To Order: [www.grizzlyjig.com](http://www.grizzlyjig.com)

# Elite

Standard Assembly



18" Tall

HTRH-04T 4 Rod \$89.95  
HTRH-03T 3 Rod \$79.99



# Pontoon Mount



5" Tall

HT-PONTOON-02T 2 Rod \$72.95  
HT-PONTOON-03T 3 Rod \$84.95  
HT-PONTOON-04T 4 Rod \$96.95

# Extreme V

Designed with the puller in mind.



18" Tall

HTRHDV-04T 4 Rod \$96.95  
HTRHDV-03T 3 Rod \$84.95



9" Short

HTRH-04S 4 Rod \$89.95  
HTRH-03S 3 Rod \$79.99



9" Short

HTRHDV-04S 4 Rod \$96.95  
HTRHDV-03S 3 Rod \$84.95

All our Hi-Tek racks come with 20" T-bar base and fasteners.



Elite or Extreme V  
Spare Base Plate  
HTRH-10 \$16.99



Extreme V  
Holder Only  
#HMBO-EXTREME  
\$13.95



Extreme V  
Holder with Block  
#HMB-EXTREME  
\$17.95



Holder Only  
#HMBO-ELITE  
\$11.95



Holder with Block  
#HMB-ELITE  
\$15.95



HTNH-01 \$34.95

Depth Finder Mount

HTDFH-02  
\$44.95

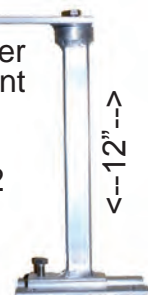

To Order: 1-800-305-9866

## Mid-South Legend: Louie Mansfield

By: Joe Sills

*Mid-South Hunting & Fishing News*

As we present these Mid-South Legends, we occasionally come across someone we have known long before they attained legendary status. Such is the case with January's Legend, Louie Mansfield, whose Grizzly Jig retail store in Caruthersville, Missouri has been acclaimed by many as "The Nation's Biggest Crappie Store".

And if it's not now, it certainly will be soon, when the new Grizzly Jig Superstore opens later this year. In development now, the gigantic 144,000 square-foot showroom, seminar venue, and warehouse will be the crappie fisherman's Heaven on Earth.

I met Louie and his sons Wade and Lance around 30 years ago while traveling the area. At the time, I was involved in fundraising for school groups. His small downtown store was brimming with fishing products, trolling motors and boat accessories such as seats, pedestals, fish finders and lures. After a brief introduction, Louie's easy-going manner was a pleasant disguise for a professional fisherman, lure maker and intense businessman. We called it, at the time, the fisherman's paradise.

Soon after, I became associated with the Mid-South Hunting and Fishing News and my relationship with the Mansfield family progressed from a business acquaintance to a valued friendship.

Louie's story rings familiar to those involved in fishing. His began as a youngster, trailing along after his dad, with a fishing pole and a can of worms. After high school, he began a career in the local barge-building industry, all the while serving his country in the Army National Guard and, of course, fishing. In 1993, Wade attended a class on fly-tying which led him into tying crappie jigs. Then he taught his dad.

His quality products were quickly being rec-

ognized over commercial offerings, and the demand became so overwhelming he contracted them to be made by a local public service organization. In 1991, he opened a small store near the present location and went full-time. The one stipulation that his wife Lancy placed on him was that the venture would not dig into the family budget.

In 2003 he began his annual January Crappie Show, which has drawn thousands of crappie anglers from all over the country.

Louie's successful tournament experience, knowledge of the species' habits and friendship with the world's top crappie anglers have led him to become recognized as THE Go-To-Crappie Expert in terms of tackle and techniques. His shipping department sends all types of related products over the entire country and overseas. His annual catalog is eagerly awaited by those that fish for many species.





Made in the U.S.A. 🇺🇸



# BEAVER BOTTOM BAITS

SHAD Infused - 2.0" - 10 Qty.

Check out our line of new Beaver Bottom Baits. With perfect color contrasts and large profiles, these baits are guaranteed to be seen!! We've also infused a shad attractant into the baits to ensure the fish will hold the bait longer. Match these baits with a Redneck Rubber Jig head to fish the total package!!

**\$3.99/10PK**



White Lightenin'-RR119



Frosty Mug-RR118



Fried Pickle-RR105



Voo Doo-RR120



Salty Dog-RR107



Ashdown Smackdown-RR112



Truman Tornado-RR109



Blue Bayou-RR121



Pink Panther-RR114



Mardi Gras-RR117



Frost Bite-RR115

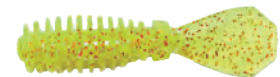

Shar Roux-RR122



Dream Sicle-RR116



Monkey Butt-RR101



Fried Okra-RR106



Grass Hopper-RR123



Cherry Mash-RR102



Green Machine-RR108



Thunder Bug-RR104



Light N Bug-RR103



Fire Alarm-RR111



Screwdriver-RR110



Blue Grass-RR113



Milk Weed-RR124



Bone Meal-RR125



Silver Tongue Devil-RR126



Big Mama-RR127



Wister Wildcat-RR128



Identity Crisis-RR129



Warmouth-RR130



Redneck Rubber LLC

These jigs fit the Beaver Bottom Baits perfectly. Featuring a 2/0 black nickel finished hook, you can feel confident when swinging those giant crappie over the rail and in the pale.

Available in 1/16, 1/8, and 1/4 oz.

**\$3.99/5PK**



Chartreuse Yellow

RRCY-1/16

RRCY-1/8

RRCY-1/4



Pink

RRP-1/16

RRP-1/8

RRP-1/4



Black

RRB-1/16

RRB-1/8

RRB-1/4

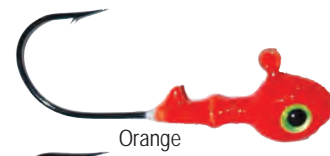

Orange

RRO-1/16

RRO-1/8

RRO-1/4

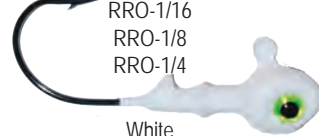

White

RRW-1/16

RRW-1/8

RRW-1/4

To Order: 1-800-305-9866

JIGS, SOFT BAITS, AND CRANK BAITS



#012  
Chart./Chart. Halo Glitter

**Mr. Crappie's SLABALICIOUS® by Strike King®, features an extra long tail "hinge" for an irresistible action!**



#021  
Chart./Monkey Shine



#030  
Chart./Black/Chart.



#039  
White/Blue/White



#061 Chart./  
June Bug/Chart.



#078  
Electric Chicken



#080 Chart./White/  
Opaque Chart.



#174 Chart./  
Popsicle



#541 White/  
Glimmer-Blue

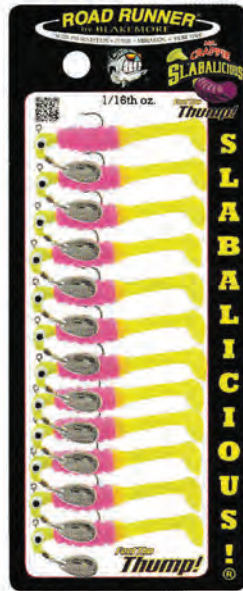

SINGLES  
1701\_\_-size  
\$1.99 ea

STRIP CARD  
12 ea  
\$19.99

SLABALICIOUS ROAD RUNNER® ORDER INFO			
Size	Hook	Strip Card	Color
1/16 oz.	#4	#1702	---
1/8 oz.	#1	#1703	---

*Extra Slabalicious® bodies are available!*

ALL  
5 PK5  
\$4.99



ALL  
12 PK5  
\$9.95



**Barbed  
Road Runner Heads  
with  
Bleeding Bait Hooks**

4 PK-1/16 oz.  
C-152-001 WHITE  
C-152-012 CHARTREUSE  
C-152-009 ORANGE

11 PK-1/16 oz.  
C-102-001 WHITE  
C-102-012 CHARTREUSE  
C-102-019 ORANGE

4 PK-1/8 oz.  
C-153-001 WHITE  
C-153-012 CHARTREUSE  
C-153-009 ORANGE

11 PK-1/8 oz.  
C-103-001 WHITE  
C-103-012 CHARTREUSE  
C-103-009 RED



**Pro Series  
with  
Brass Willow Blades**

4 PK-1/16 oz.  
C-162-001 WHITE  
C-162-012 CHARTREUSE

11 PK-1/16 oz.  
C-112-001 WHITE  
C-112-012 CHARTREUSE

4 PK-1/8 oz.  
C-163-001 WHITE  
C-163-012 CHARTREUSE

11 PK-1/8 oz.  
C-113-001 WHITE  
C-113-012 CHARTREUSE

# CRAPPIE THUNDER® Road Runner® by Mr. Crappie®

The CRAPPIE THUNDER Road Runner features:  
a long-lasting solid-body, a flared-tail  
for a slower descent and longer presentation



**Tips: Be ready to change colors when the wind picks up or if you get cloud cover.**

**Don't forget to try fishing shallow-shady areas in the spring. Spare Crappie Thunder bodies are available at Strike King Lures.**

SINGLES  
1801\_\_-size  
\$1.99 ea

STRIP CARD  
12 ea  
\$19.99



CRAPPIE THUNDER ROAD RUNNER ORDER INFO			
Size	Hook	Strip Card	Color
1/16 oz.	#4	#1802	---
1/8 oz.	#1	#1803	---

To Order: 1-800-305-9866



# Arkie 350

**\$3.99**

The hottest Crankbaits going for Crappie, Walleye and Bass!  
 Casting, Cranking, Trolling, Pushing or Pulling these baits will make  
 your partner a better net handler, guaranteed!



#20 Pink Black



#83 Blue Chart



#84 Black Chart Splash



#22 Orange Chart



#86 Pink Black Splash



#85 Chart Black Splash



#33 Black Purple



#27 Orange Black



#24 Chart Black



#82 Chart Blue



#87 Pink Chart Splash



#58 Strawberry Lemon



#57 Lemon Lime



#80 Black Pink



#65 Mad Dawg



#41 Pink Sparkle



#40 Orange Sparkle



#45 Lemonade



#44 Marmalade



#42 Chartreuse Sparkle



#81 Pink Black/Chart



#63 Wild Thang



#31 Purple Pink



#43 Black Bubble Gum



#30 Orange Black White



#71 Chart Stripe



#73 Orange Stripe



#70 Blue Stripe



#72 Pink Stripe



#74 Striped Wild Thang



#64 Grass Shrimp



#29 Okatibbee



#62 Purple Dawn



#46 Pearl



#25 Chart Orange Stripe

Looking for a way to extend your Crappie season? Trolling for Crappie has become a year round method for putting fish in the boat, and is very effective in the Summer and Fall. Use these charts to adjust line length and bait depth as needed for your conditions. Trolling speeds range from 1.2 MPH up to 2.2 MPH.

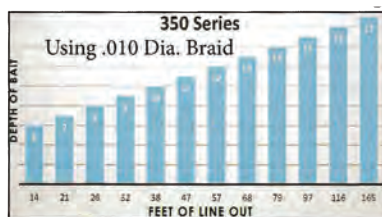

Arkie Field Tester, David Shands a.k.a. "G" of Crappie.com, is shown with some nice Summer time Crappie, caught while trolling Arkie Crankbaits!

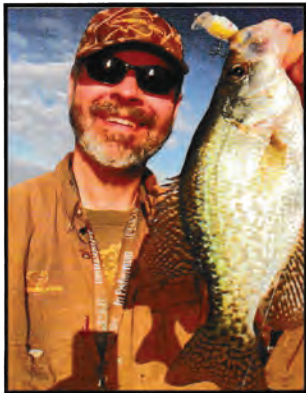

First, we designed the right shape of bait to match natural forage in two different sizes. Next, we created a diving bill that generates one of the most enticing actions in the water while running true right out of the package! Then we implemented a dual rattle system that combines two sounds into one for a distinct vibration and sound, a sound only found in an Arkie Crankbait. We finished by adding super sharp red hooks to over 60 colors for any array of water, light, & forage conditions.

### 350 SERIES



#35 Chrome Clown



350 Series Crank, PRODUCT CODE: CD3-



#55 Kentucky Shad



#51 Shad



#54 Arkansas Shad



#56 Missouri Shad



#3 Sexee Shad



#59 Cotton Candy



#92 Tennessee Shad



#53 Cajun Shad



#13 Splattershad



#32 Perch



#2 Black Shiner



#4 Blue Shiner



#5 Black Gold



#16 Firetiger



#60 Crappie



#52 Blue Bayou



#14 Bluegill



#36 Black



#61 Mudbug



#50 Sunfish



#90 Spring Craw



#67 Green Craw



#66 Brown Craw



#91 Ghost Craw



#18 Red Craw



#21 Chart Black Stripe



#23 Chart Pink Stripe



#28 Orange Black Stripe



#19 Chart Blue Stripe



#26 Pink Black Stripe



### Expand your trolling set up by pushing Crankbaits!

There's more than one way to troll Crankbaits, as Arkie Field Tester and paint designer Scott Vance, a.k.a. ScottyV of Crappie.com, shows with a couple of nice crappie caught pushing the Arkie Crankbaits.



To Order: 1-800-305-9866

\$5.99/ea



Buy-6  
\$5.50 ea



#B300-\_\_\_  
color

2 inches long  
runs 8 to 12 feet



#BGLO-\_\_\_  
color

### Glow Crappie Bandits



Glow Series-01  
Green/Blk Splatter



Glow Series-03  
Pink/Silver Spk



Glow Series-05  
Chart/Blue Back



Glow Series-06  
Two Tone

## CRAPPIE

#B-CR-\_\_\_  
color





01  
Baby Bass



02  
Tenn Shad



03  
Prl/Blk Back



04  
Brn Craw/Org  
Belly



06  
Chrt/Blk Stripes



07  
Humble Bee



08  
LA Shad



09  
Prl/Red Eyes



15  
Prl/Chrt Back



18  
Solid Black



19  
Chrt/Grn Back



20  
Fire Tiger



21  
Hot Chocolate



22  
Parrot/Orange



26  
Spring Craw/  
Yellow



31  
Chr/Blk Back



32  
Chr/Blue Back



36  
Chrt/Blue Back



38  
Red Crawfish



41  
Chrt Belly



43  
Splatterback



43B  
Blue Splatterback



58  
Mistake



65-SPEC  
Purple Tiger  
Stripes



76  
Slv Minnow  
Sparkle



82  
Chrt/BlkBack/  
Scales



83  
Prl/Blue Back



88  
Prl/Chrt Belly



A05  
Rootbeer



A20  
Threadfin Shad



A28  
Chrt/Rootbeer



B06  
Avocado Splatter



B38  
Cr Bluegill



B49  
Red Spring Craw



B50  
Brn Fall Craw



B51  
Grn Speckled  
Craw



B52  
Blue Ghost



B60  
Citrus Shad Chr



D01  
Citrus Shad



D02  
Taco Salad



D09-SPEC  
Awesome Pink



D21  
Mad Cow



D23  
Wild Thing



D26  
Salad Bar



D35  
Sun Perch



D37  
River Bream



**\$5.99 EACH**

**BUY-6 \$5.50 EACH**



D38  
Crappie



D62  
Natural Shad



D66  
Chrt Fleck



D67  
Metal Flake Shad

**To Order: 1-800-305-9866**

NEW  
from Grizzly Jig Co.



# Grizzly's Elite Jigs



685-Crystal Pink

**\$3.49**  
**4 PK**

- Hand Painted
- Black Nickle Needle Point Hooks
- Multi-Tone with 3D Eyes
- 1/4 oz. Head....Just for Grenada Crappie!

Item	Size	Hook
GJC-GE-162_ _ _	1/16 oz.	#2
GJC-GE-181_ _ _	1/8 oz.	#1
GJC-GE-1420_ _ _	1/4 oz.	#2/0



850-Rainbow Trout

860-Bumble Bee



670-Purple



680-Killer Orange



675-Chartreuse Tiger



689-Fire Tiger



681-Minnow



690-Black Neon

NEW  
from Grizzly Jig Co.



# Grizzly's Crystal Elite Jigs

**\$2.99 - 3 PK**  
**\$10.99 - DOZEN**

- Minnow Heads
- Double Painted Eyes
- Hand Tied with ICE Chenille & Feathers
- Red Eagle Claw Hooks

Item	Size	Hook
GJC-CFJ-324_ _ _	1/32 oz.	#4 Red
GJC-CFJ-162_ _ _	1/16 oz.	#2 Red
GJC-CFJ-182_ _ _	1/8 oz.	#2 Red



#5-Orange/Chartreuse



#1-White



#2-Chartreuse



#3-Black/Yellow

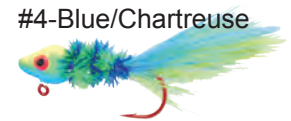

#4-Blue/Chartreuse



#6-Pink/White



#15-Black

## Lindy True-Spin



**\$1.99 - PK**

Item	Color	Size	Qty
SP800	Nickel	1	3 pk
SP810	Nickel	2	3 pk
SP801	Gold	1	2 pk
SP811	Cold	2	2 pk

## Lindy 4MM Beads

- \$1.99 - 125 PK**
- LB405 Silver
  - LB402 Pearl
  - LB417 Glow
  - LB416 Red Metallic





# Grenada Sickles

FT-Fire Tiger



\$3.29  
5 PK

-  NS- Natural Shad
-  OC- Orange/Chart
-  PW- Pink/White
-  KO- Killer Orange
-  RT- Rainbow Trout
-  LC- Lime/Chart

**FEATURES:**

- Special Tapered Wedge Shaped Head Design
- Two-Tone, Multi-Tone and X-Glo Finishes with Holographic Eyes
- Black Nickel Sickle Hook with Fine Wire and Needle Point
- Barb Shoulder to Hold Live Bait or Plastics
- Pacakged in Reusable Vinyl Bag

ITEM #	SIZE	HOOK
GJC-GS-18__	1/8 oz	#1/0
GJC-GS-14__	1/4 oz	#2/0

## Grizzly's Grenada Rattlers Coming Soon!!

**NEW**  
From Grizzly Jig Co.

# PRO Grenada Sickles



with Blade  
\$4.49  
5 PK

LIVE SCOPE STYLE

-  Just Remove the Blade
-  1-White
-  3-Black
-  6-Pink
-  8-Orange
-  10-Chartreuse

**FEATURES:**

- Hammered nickel willow leaf
- Oversized black nickel needle point hook
- Barbed shoulder
- Aspirin head with hologram dome eyes

ITEM #	SIZE	HOOK
GJC-RHVS16__	1/16 oz.	#1/0
GJC-RHVS18__	1/8 oz.	#1/0
GJC-RHVS14__	1/4 oz.	#1/0

To Order: 1-800-305-9866



**GRIZZLY JIG  
COMPANY**

**\$2.99 - 3 PK  
OR  
\$10.99/DOZEN**

**1/32 oz. Grizzlys  
FOR SLOW-FALL  
CRAPPIE  
FISHING**

**Grizzly Jigs**

**#GJC-G32\_ \_**



06 GRIZZLY WHITE



07 BLACK



10 CHARTREUSE



11 BLACK ON RED



14 JUNEBUG



16 OTIS



21 BLACK/CHART.



22 CUNNINGHAM



23 MCGRAW SPECIAL



28 BO



30 ORANGE/WHITE



31 TIDWELL'S TEAL



34 NORMAN'S RAINBOW



35 KELLY GREEN



37 KILLER



40 LOU'S HOT BROWN



45 BULLFROG



47 PERCH



52 KATYDID

**Grizzly's Mississippi Style Crappie Jigs**

**1/16 oz. #GJC-MS16\_ \_**



01 ORANGE/CHART.



02 PINK/WHITE



03 BROWN/YELLOW



04 KELLY GREEN



05 BLACK/WHITE



06 ORANGE/BLACK/CHART



07 CHART./BLACK



08 BLACK/YELLOW



09 BLACK/CHART.



10 YELLOW/WHITE



11 YELLOW/PURPLE



12 CHART./BLACK/KELLY



13 CHART./PINK



14 CHART./ORANGE



15 BLACK EMERALD



16 KATYDID

**Grizzly's Google Eye Jigs**

**#GJC-GE16\_ \_**

with

**Dancin, Rattling Eyes**

**1/16 oz.**

**Google Eye Jigs**



01 BLACK



02 WHITE



03 RED/BLACK



04 CANDY



05 ORANGE



06 CUNNINGHAM (WHITE/RED/BLACK)



07 TIDWELL'S TEAL (ORANGE/GRIZZLY GRAY)



08 BO (RED/BLACK/YELLOW)



09 CHARTREUSE



10 WILLOW FLY/CHART/GRIZ GRAY



13 RED/CHART



11 BLACK/CHART



12 KILLER (ORANGE/BLACK/CHART)

**To Order: [www.grizzlyjig.com](http://www.grizzlyjig.com)**



# GRIZZLY JIG COMPANY

## 1/80 oz. Grizzlys

- Hand tied on a size 10 dry fly hook
- The jig and technique worthy enough to write a book about. See *Grizzly Fishin'* by Tim Huffman and the new Grizzly fishing video with Tim Huffman and Louie Mansfield.

Grizzly Jigs

**\$2.99 - 3 pk. OR \$10.99/DOZEN**  
**#GJC-G80\_\_**



01 GRIZZLY GRAY



02 GRIZZLY BROWN



03 GRIZZLY YELLOW



04 GRIZZLY GREEN



05 GRIZZLY ORANGE



06 GRIZZLY WHITE\*



07 BLACK\*



08 WHITE



09 PURPLE



10 CHARTREUSE\*



11 BLACK ON RED\*



12 SUZY BROWN



13 GRIZZLY GOLD



14 JUNEBUG\*



15 TEAL



16 OTIS\*



17 BLACK ON YELLOW



18 CANDY



19 RED



20 ORANGE



21 BLACK ON CHART\*



22 CUNNINGHAM\*



23 MCGRAW SPECIAL\*



24 REDHEAD GRIZZLY



25 BILL'S WATERFLEA



26 CHART ON GIN GREEN



27 H.PINK/GUINEA BLUE



28 BO\*



29 CRAWDAD



30 ORANGE & WHITE\*



31 TIDWELL'S TEAL\*



32 SUZY YELLOW



33 WILLOW FLY



34 NORMAN'S RAINBOW\*



35 KELLY GREEN\*



36 SKY BLUE



37 KILLER\*



38 H. PINK & BLACK



39 PURPLE OTIS



40 LOU'S HOT BROWN\*



41 USA



42 JAIL BIRD



43 FIRETAIL



44 GLOW



45 BULLFROG



46 STARBURST



47 PERCH



58 GLO-ORANGE



59 GLO-GREEN



60 GLO-BLUE



51 COTTON CANDY



52 KATYDID



53 CHART/PINK



54 GRIZZLY CHART



57 GLO-WHITE

To Order: 1-800-305-9866



MRCSS



Length: 2 1/4"  
(Each available 15 per package)



Colors

- 41 Glimmer Blue
- 48 Pumpkin/Chart
- 183 Tuxedo Black/Chart
- 186 Refrigerator White
- 194 Pink Tuxedo
- 277 Monkey Shine
- 242 Hot Chicken

15 CT  
\$2.99

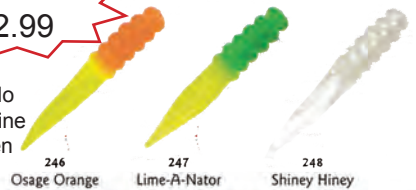

246 Osage Orange    247 Lime-A-Nator    248 Shiny Hiney

The Mr. Crappie Jokers are designed with a solid body and three vibrating tails that drive the crappies wild!



15 CT  
\$2.99

(Each available 15 per package)

Great for vertical, casting, long line trolling, tight line trolling and catch crappie in all types of cover!

Trollers Love'em!



41 Glimmer Blue    48 Pumpkinseed/Chartreuse    60 Electric Chicken    174 Popsicle    181 Blue Grass    183 Tuxedo Black/Chartreuse    184 Tuxedo Black/Sparkle Laminare    185 Blue/Pearl    186 Refrigerator White  
187 Red/Chartreuse Sparkle    188 Junebug Chartreuse    192 Electric Lime    193 Cajun Cricket    223 Purple Sage    225 Acid Rain    226 Blue Tuxedo    242 HotChicken.com

The Mr. Crappie Crappie Thunders are designed with a solid ripple body and the tails that flare out at 90 degrees!



15 CT  
\$2.99

(Each available 15 per package)

Great for vertical, casting, long line trolling, tight line trolling and catch crappie in all types of cover!

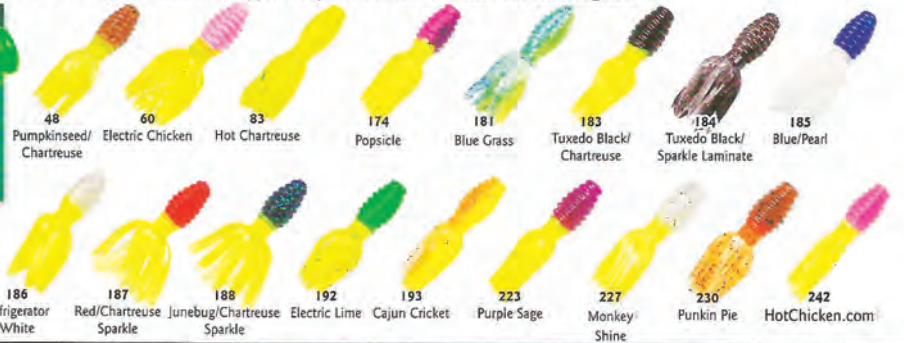

48 Pumpkinseed/Chartreuse    60 Electric Chicken    83 Hot Chartreuse    174 Popsicle    181 Blue Grass    183 Tuxedo Black/Chartreuse    184 Tuxedo Black/Sparkle Laminare    185 Blue/Pearl  
186 Refrigerator White    187 Red/Chartreuse Sparkle    188 Junebug/Chartreuse Sparkle    192 Electric Lime    193 Cajun Cricket    223 Purple Sage    227 Monkey Shine    230 Punkin Pie    242 HotChicken.com



15 CT  
\$2.99

Length: 2"

The Mr. Crappie Slabalicious™ (Crappie Swim Bait) is designed for casting, trolling, pulling, flipping or pitching! Great swimming action and vibration from the unique tapered design and a special paddle tail that crappie can't resist!



41 Glimmer Blue    48 Pumpkinseed/Chartreuse    60 Electric Chicken    174 Popsicle    183 Tuxedo Black/Chartreuse    185 Blue/Pearl    186 Refrigerator White    187 Red Chartreuse  
188 Junebug Chartreuse    193 Cajun Cricket    194 Pink Tuxedo    195 Chartreuse Shiner    225 Acid Rain    226 Blue Tuxedo    227 Monkey Shine    235 TN Shad Chartreuse Tail    242 HotChicken.com

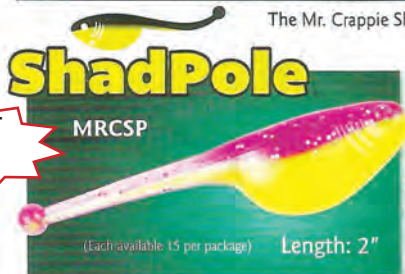

15 CT  
\$2.99

MRCSP

(Each available 15 per package)

Length: 2"

Great for flippin', dippin', skippin', trollin' or shootin'!

The Mr. Crappie ShadPole®s are designed with the darting action of a Threadfin Shad and a squiggin' tail like a Tadpole!



41 Glimmer Blue    48 Pumpkinseed/Chartreuse    57 Smokey Shad    60 Electric Chicken    164 Salt-N-Pepper    183 Tuxedo Black/Chartreuse    186 Refrigerator White    188 Junebug Chartreuse    192 Electric Lime  
193 Cajun Cricket    194 Pink Tuxedo    195 Chartreuse Shiner    196 Red Chili Pepper    222 Blue Ice    223 Purple Sage    224 Pepper Shad    230 Punkin Pie    242 HotChicken.com



# SPIN BABY

With **ShadPole<sup>CT</sup>** Body



Finally! Mr. Crappie® and Strike King® have come up with the world's best crappie spinnerbait. Designed with total vibration with a custom willow blade and the Shadpole<sup>CT</sup> body. Great for trolling and casting in creeks, ponds or lakes. Hook up with a Spin Baby™ today! Comes in 1/8 oz. size with Eagle Claw® Light Wire Platinum Black Hook.

Mr. Crappie™ Spin Baby  
**MRCSB18**



**\$3.59**  
per kit  
1 Bait w/  
2 Bodies



Mr. Crappie™ Scizzor Shad  
**MRCSZR116S • MRCSZR18S**



The All New Revolutionary Scizzor Shad™ by Mr.Crappie™ is designed to cast, vertical jig or troll! Scizzor Shad™ has the Mr.Crappie™ signature balls and twin tails for twice the action! It has a secret port for any type of crappie scent and 3D eyes for a natural shad like presentation! Mr.Crappie™ and Strike King® are #1 in design and producing the most innovative crappie baits ever made! The Mr. Crappie™ Scizzor Shad™ is made for wackin' and stackin'!



**\$3.59**  
3 pk

NEW FOR 2020

# NEW MR. CRAPPIE® SNAP JACK

SIZE: 2"  
\$2.99  
15 pk

MRGSNAP

The Snap Jack by Strike King is two inches long Solid Body with Twin Wedge tails! The Snap Jack is designed for trolling, casting and vertical jiggling! The win Wedge Tails moves a lot of water especially when casting and vertical techniques! It's a Crappie Catcher!" says Wally Marshall, aka Mr. Crappie. This lure will be a go-to for the fisherman who wantsto fill the livewell."



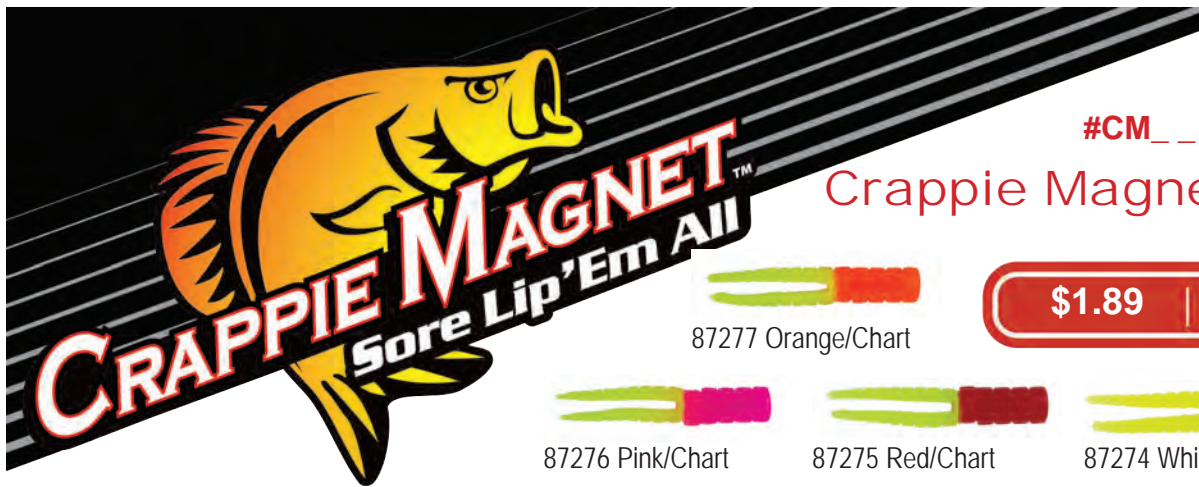

#CM\_\_\_\_\_ Crappie Magnets

\$1.89 | 15 PK

				
			87277 Orange/Chart	
				
87273 Black/Chart	87272 Opaque/Chart	87271 Blue/White	87270 White	87269 White/Red
				
87266 Pink/Pearl	87263 Chart w Black Flk	87262 Chart w Silv Flash	87261 Red/Chart Flash	87260 Black/Chart FI
				
87256 White/Blue/Slv Flk	87231 Midnight Blue	87230 Green w Red Flk	87257 ShoNuff	32101 Therapist
				
32103 Spicy Mustard	32102 Percy	32104 Heavy D	13003 Purple Haze	11124 Killer Klatt
				
11117 Blake's Glow	11115 Salt & Pepper	11113 Wizard Glow	14071 Pumpkin Pie	14073 Fast Lane
				
14075 Zoe's Glow	14024 Bison	14065 Norma Jean	14069 Glow Pop	17005 Mermaid
				
13026 Electric Chicken	18077 ShoNuff/Chart	19082 Butla Gold	19083 Watermelon	19084 Midnight Pink

Fin Spin

\$9.99 | 11 PK

#FS\_\_\_\_\_

		
1/4 oz. 19000	1/4 oz. 19001	1/4 oz. 19002
1/8 oz. 19003	1/8 oz. 19004	1/8 oz. 19005
1/16 oz. 19006	1/16 oz. 19007	1/16 oz. 19008

Double Cross Jigheads

\$6.49 | 25 PK

#DCJH\_\_\_\_\_

1/32oz-Size 3  
1/16oz-Size 3  
1/8oz-Size 3

				
WHITE	CHART	PINK	NICKEL	UNPAINTED
11083	11084	11082	11081	11099
11075	11076	11074	11073	11097
11067	11068	11066	11065	11095

# Slab Curly

#SC\_\_\_\_\_

**\$1.99 | 12 PK**



19121 Black/Chart    19122 Black Widow    19123 Butla Gold    19124 Blake's Glow    19127 Candy Corn Fls  
 19128 Dude Flash    19129 Harlan    19130 Mardis Gras/Chart    19131 Midnight Blue    19132 Midnight Blue/Wte  
 19144 Midnight Flash    19134 Mermaid    19135 Pink/Chart    19136 Princess    19137 Red/Chart  
 19138 Sardis Gold/Chart    19138 ShoNuff/Chart    19140 Therapist    19141 Tenn Shad    19142 White/Chart  
 19143 Wizard's Glow    19239 Trick-or-Treat    19240 Pumpkin Pie    19241 Midnight Pink    19242 Chart/Orange

#SM\_\_\_\_\_

# Slab Magnet

**\$1.89 | 8 PK**



15000 Or/Chart Glow    15001 Pink/Chart    15006 Wizard Glow  
 15007 Fast Lane    15009 Chart/Blk Flk    15011 Canned Tomatoes    15013 Salt & Pepper    15014 Zoe's Glow  
 15015 Percy    15016 Chartreuse    15018 Dude    15019 Wht/Chart    15020 Red/Chart  
 15021 Black/Chart    15022 Blake's Glow    15026 Double Ugly    15029 Chartreuse Ice    15047 Pale Moon  
 15075 Lemon Meringue    17421 Mermaid    19076 Cajun Cricket    19077 Candy Corn    19078 Elsie's Glow  
 19079 Midnight Blue/Wht    19080 Sunset Glow    19081 Sardis Gold/Chart    15004 Therapist    15005 ShoNuff

## MUDDY WATER (15030)



## CLEAR WATER (15031)



## GLOW (15033) **\$1.89**





### Crappie Magnet Mini Skirt

**\$2.99 | 4 PK**

BLACK/CHART  
19258



CANDY CORN  
19257



MARDI GRAS  
19254

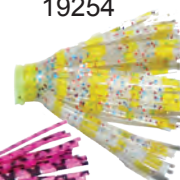

#MS\_\_\_\_\_

MERMAID  
19252



NORMA JEAN  
19259



OCTOBER  
19260



### Fin Spin Pro Series

#FSPS\_\_\_\_\_

**\$2.99 | 2 PK**

WIZARD'S CHART

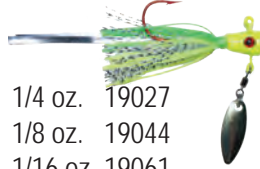

1/4 oz. 19027  
1/8 oz. 19044  
1/16 oz. 19061

CANDY CORN ORANGE

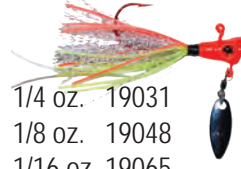

1/4 oz. 19031  
1/8 oz. 19048  
1/16 oz. 19065

POP CHART



1/4 oz. 19032  
1/8 oz. 19049  
1/16 oz. 19066

LES PINK



1/4 oz. 19035  
1/8 oz. 19052  
1/16 oz. 19069

FANCY PINK

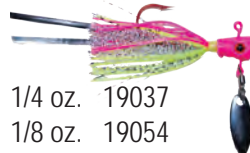

1/4 oz. 19037  
1/8 oz. 19054  
1/16 oz. 19071

OCTOBER ORANGE



1/4 oz. 19039  
1/8 oz. 19056  
1/16 oz. 19073

THERAPIST

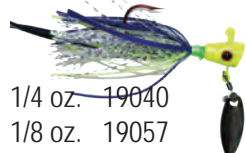

1/4 oz. 19040  
1/8 oz. 19057  
1/16 oz. 19074



## VIE Shiner

From **Mister Twister**

Designed and tested by crappie guides and tournament anglers in 3 states. The vertical twin paddle tails displace more water, create more vibration, and impart an extreme swimming action. Small (1 3/4") shiner profile with an enhanced scale pattern. Every VIE Shiner is laminated, tri-colored or multi-colored for added visibility.



310-Black/Chartreuse



13GNS10-Junebug/Chartreuse



0S510S-Clear Flake/Blue/Chartreuse Silver Flake



0S-Clear Silver Flake/Black Back



58BK0S-Blue/Orange Black Flake/Clear Silver Flake



N7BS1P-Smoke Blue Flake/Pearl



128BK10P-Lime Blk Flk/Orange Blk Flk/Chartreuse



591-Blue/Red/White



31-White Pearl/Black Back



9010S-Red/Clear/Chartreuse Flake



31P10S-Black/Pearl/Chartreuse Silver Flake



N122BK-Lime Black Flake/Yellow



3610S-Black/Pink/Chartreuse Flake



N12BK1P-Lime Black Flake/Pearl



3S0S0RS-Black Silver Flk/Clear Silver Flk/Clear Red Flk



N3RS10P-Black Red Flake/Chartreuse Pearl



51P0S-Blue/Pearl/Clear Silver Flake



N3RS1P-Black Red Flake/Pearl

1 3/4" VIE Shiner  
10/resealable bag

Stock #  
VS10

Be sure to add the color  
code # after the stock #

Price  
\$4.29

To Order: [www.grizzlyjig.com](http://www.grizzlyjig.com)



## 2" Teenie™



### The Original Twister® Tail

**\$2.49**

TTSF20 + Color

**Solid and Flake (SF) 20 PK**

1-White



2-Yellow



3-Black



4-Purple



6-Pink



8-Orange



9R-Rocket Red



10-Chartreuse



10S-Chartreuse Flake



11BKS-Pumpkin Pepper



14BBG-Watermelon  
Blue, Black, Gold Flake



LS-Luminescent



DA10-Milktreuse



20-Motor Oil

## Curly Tail® Grubs

Your Choice  
**\$3.99**

TTO20 + Color

**Multicolors 20 PK**



198-Brown/Orange Tail



2410BK-Carolina Pumpkin/  
Chartreuse Tail



310P-Black/Chartreuse Pearl Tail



091-Opaque Red/White Tail



122BK-Lime/Black Flake/Yellow Tail



129BK-Lime/Black Flake/  
Opaque Red Tail



16-White/Firetail



90S-Opaque Red/Clear Flake Tail

**Bloodline 20 PK**



93-Red/Black Line



03-Clear/Black Core



143-Chartreuse/Black Line



108-Chartreuse/Orange Core



101S-Neon Chartreuse Flake



61S-Neon Pink Flake

# Micro Crawfish



32GN  
LA Craw

7RS  
Smoke/Red Flake

24  
Natural

N39  
Black & Red

The Mister Twister® Micro Crawfish is a great Micro Mania lure that can fool even the most cautious slab crappie, big bream or trout. It's the perfect duplication of a baby crawfish. Designed to mimic Mother Nature, the Mister Twister® Micro Crawfish comes in the natural colors fish love. Fish it with a 1/16 oz. or 1/32 oz. jighead or rigged on a single hook for a natural presentation.

# Micro Shad



103-Chartreuse/  
Black Back

31-White Pearl/  
Black Back

1P-White Pearl

105-Chartreuse  
Flake

Mister Twister® downsized its Sassy Shad®, one of the most successful lures of all time, to produce the Micro Shad. Only 1-1/8" long, the Micro Shad is designed specifically for trout, crappie and bream. Rig it on a 1/64 oz. jighead. Proven design and a great color selection make the Mister Twister® Micro Shad perfect for both the trout and panfisherman.

# Nymph



198-Brown/Orange

219-Yellow/Brown

1P-White Pearl

3-Black

11BKS-Pumpkin Pepper

## Perfect for Trout or Panfish

The Mister Twister® Nymph is another great trout, crappie and bream lure that will truly "match the hatch." The Nymph is the perfect duplication of a mayfly nymph designed to mimic Mother Nature. At 1/4" long, not only are the colors perfect, so is the size. Fish this little creature with a 1/16 oz. or 1/32 oz. jighead or rigged on a single hook to provide a more natural presentation.

Micro Crawfish	Stock#	Price
20/resealable bag	MCF20	\$3.49
Micro Shad	Stock#	Price
20/resealable bag	MMS20	\$3.49
1 1/4 Nymph	Stock#	Price
20/resealable bag	MMN20	\$3.49

Be sure to add the color code # after the stock #.



To Order: [www.grizzlyjig.com](http://www.grizzlyjig.com)

# 2" HOT GRUB

**\$4.79**  
**50 PK**

JIGS, SOFT BAITS, AND CRANK BAITS



HG01 - Tennessee Shad



HG02 - Bad Blood



HG03 - Blue Shiner



HG04 - Smoke Blue & Gold Spk/  
Clear Gold Sparkle



HG05 - Acid Rain



HG06 - Crawdad



HG07 - Red Head



HG08 - Jawbreaker



HG09 - Acid Rain/Junebug



HG10 - Bumble Bee



HG11 - Wally World



HG12 - Chartreuse Shad



HG13 - Junebug/Chartreuse



HG14 - Black/Blue/Chartreuse



HG15 - Green/Yellow



HG16 - Lemon Meringue



HG17 - Blue/Chartreuse



HG18 - Wildcat/Chartreuse



HG19 - Sourgrape/Chartreuse



HG20 - Orange Crush



HG21 - Bubblegum/Chartreuse



HG22 - Black/Red/Chart Sparkle



HG23 - Orange Chartreuse Crush



HG24 - Yellow Jacket



HG25 - Popsicle



HG26 - Firetiger



HG27 - Green Hornet



HG28 - Halloween



HG29 - Kentucky Lake Killer



HG30 - Mistake



HG31 - Double Trouble



HG32 - Black/Chartreuse Spk



HG33 - Bleeding Tenn. Shad



HG34 - Weiss Lake Killer



HG35 - Red Shiner



HG36 - Albino Shad



HG37 - Fire & Ice Shad



HG38 - Tenn Shad/Chartreuse Sparkle



HG39 - Electric Chicken



HG40 - All American



HG41 - Black Gold Shiner



HG42 - Watermelon Sunset



HG43 - White Lightning



HG44 - Purple Shad



HG45 - Rosey Red



HG46 - Perch



HG47 - Pumpkin Shad



HG48 - Arkansas Shad



HG49 - Black/Chartreuse



HG50 - Pearl



HG51 - Chartreuse Sparkle



HG52 - Lime Sparkle



HG53 - Pure White



HG54 - Blue/White/Chart  
with Red Sparkle



HG55 - JuneBug



HG56 - Blue Ice/Chart Sparkle



HG57 - Pinky Shad



HG58 - Smurf Limeade



HG59 - Monkey Milk



HG60 - Monkey Milk Chartreuse



To Order: 1-800-305-9866

# 2" TRIPLE TIP GRUB

\$4.79  
50 PK



# 2.5" BASS SHAD

\$2.49 - 15 PK

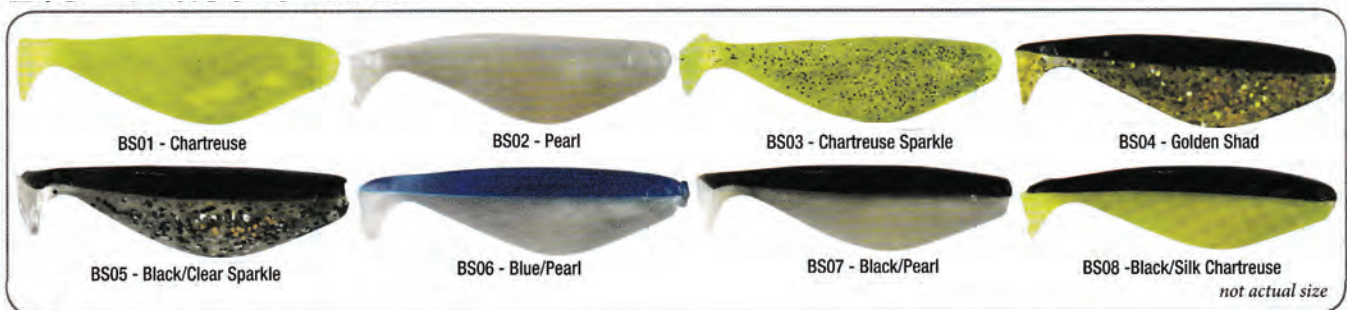

# 2" CRAPPIE MAGNUM

*Solid Body*  
**\$2.19 • 10 PK**

JIGS, SOFT BAITS, AND CRANK BAITS



- 2CM01 - Tennessee Shad
- 2CM02 - Black Red/Chartreuse
- 2CM03 - Black/Blue/Chart Sparkle
- 2CM04 - Red/Pink/Pearl
- 2CM05 - Orange/White/Chart Sparkle
- 2CM06 - Lemon Meringue
- 2CM07 - Black/Blue/Pearl
- 2CM08 - Blue Shiner
- 2CM09 - Green/Yellow
- 2CM10 - Popsicle
- 2CM11 - Pumpkin/Orange/Chartreuse Pepper
- 2CM12 - Chartreuse Shad
- 2CM13 - Red/White
- 2CM14 - Blue/White
- 2CM15 - White/Chartreuse Sparkle
- 2CM16 - Monkey Milk
- 2CM17 - Smoke Neon / Glow
- 2CM18 - Black / Chartreuse Glow
- 2CM19 - Pink/White Glow
- 2CM20 - Orange/Chartreuse Glow
- 2CM21 - Red/Chartreuse Glow
- 2CM22 - Lime/Chartreuse Glow
- 2CM23 - Pumpkin / Chartreuse Sparkle
- 2CM24 - Pearl Glow

# 2" CRAPPIE STINGER

**\$1.99 • 10 PK**

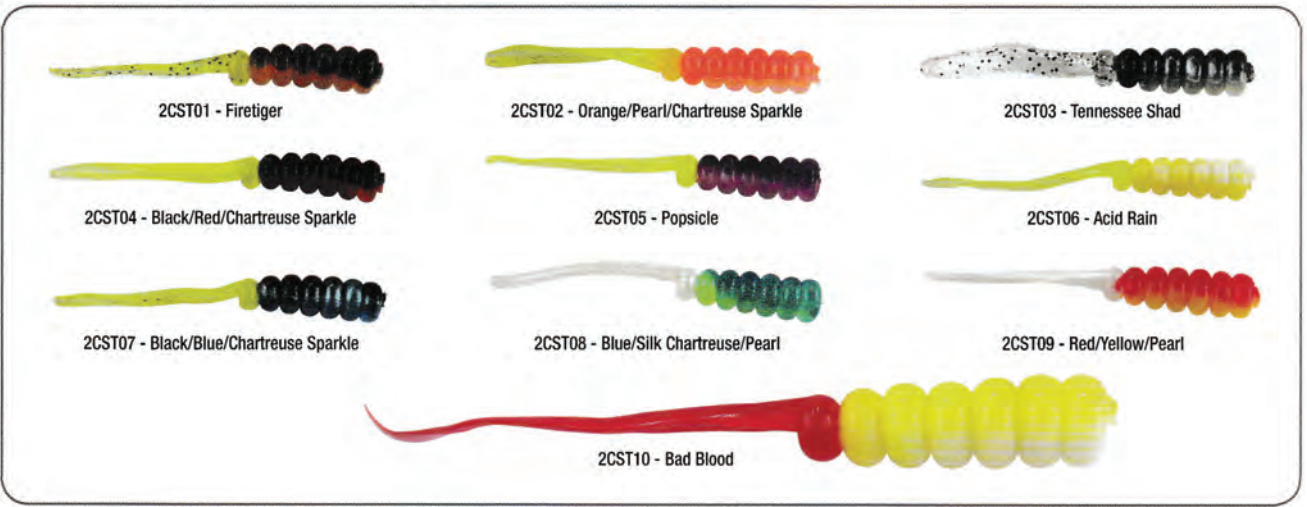

- 2CST01 - Firetiger
- 2CST02 - Orange/Pearl/Chartreuse Sparkle
- 2CST03 - Tennessee Shad
- 2CST04 - Black/Red/Chartreuse Sparkle
- 2CST05 - Popsicle
- 2CST06 - Acid Rain
- 2CST07 - Black/Blue/Chartreuse Sparkle
- 2CST08 - Blue/Silk Chartreuse/Pearl
- 2CST09 - Red/Yellow/Pearl
- 2CST10 - Bad Blood

# 1.5" PRO SERIES LIT'L HUSTLERS

**\$1.59**  
**10 PK**



PT01 - Tennessee Shad



PT02 - Kentucky Lake Killer



PT03 - Popsicle



PT04 - Blue Shad



PT05 - Money



PT06 - Junebug / Chartreuse



PT07 - Cajun Cricket



PT08 - Red Shad



PT09 - Weiss Lake Killer



PT10 - Kryptonite



PT11 - Mexican Sunrise



PT12 - Lightning Bug Glow

# 1.5" SCALE HEAD LIT'L HUSTLERS

**\$2.99**  
**50 PK**



SH01 - Red/White



SH02 - Blue/White



SH03 - Red/Chartreuse



SH04 - Orange/Chartreuse



SH05 - Blue/Chartreuse



SH06 - Silver/White



SH07 - Chartreuse/White



SH08 - Silver/Chartreuse



SH09 - Silver/Firetail



SH10 - Purple/Chartreuse



SH11 - Green/Chartreuse



SH12 - Blue/Yellow



SH13 - Orange/Pumpkinseed



SH14 - Blue/Black



SH15 - Purple/Black



SH22 - Chartreuse/Chartreuse



SH23 - Black/Chartreuse



SH25 - Blue/Firetail



SH27 - Silver/Red



SH28 - Orange/Watermelon

# 1.5" PANFISH STINGER

**\$1.99**  
**10 PK**



PS01 - Black/Chartreuse Sparkle



PS02 - Red/White

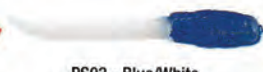

PS03 - Blue/White



PS04 - Red/Chartreuse Sparkle



PS05 - Black/White



PS06 - Chartreuse



PS07 - Red/Yellow



PS08 - Pearl



PS09 - Black/Firetail



PS10 - White/Chartreuse Sparkle

# 1.5" LIT'L HUSTLERS

America's #1 Crappie Tube!!!

\$2.99 - 50 PK



# 1.5" RAINBOW TUBES

\$1.59 - 10 PK



To Order: 1-800-305-9866

JIGS, SOFT BAITS, AND CRANK BAITS

# 1.5" TRI-COLOR LIT'L HUSTLERS

\$2.99  
50 PK



# 1.5" HOT TUBE LIT'L HUSTLERS

\$1.89  
10 PK



# 2" MINNOW TUBE

\$1.69 - 6 PK

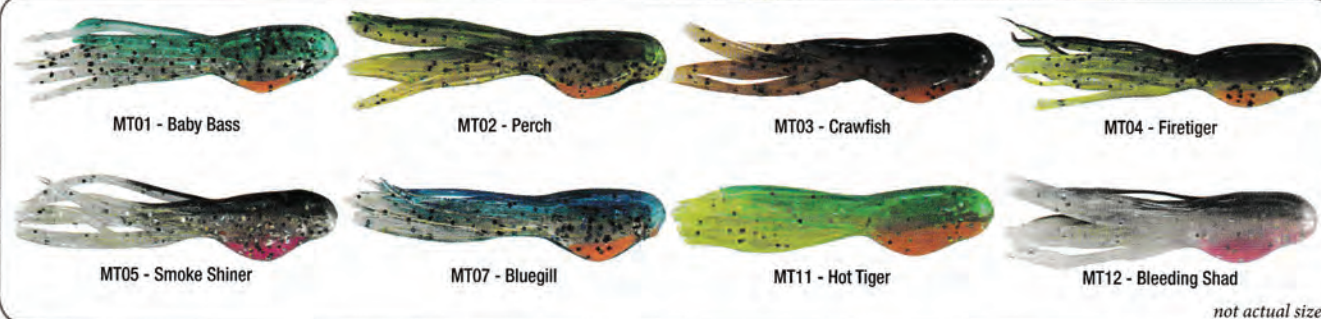



# 2" UMBRELLA CRAPPIE TUBES

**\$3.99**  
**25 PK**

JIGS, SOFT BAITS, AND CRANK BAITS



# 1.5" CRAPPIE CRAW

**\$1.99 - 10 PK**



To Order: 1-800-305-9866

# 1.5" GLOW LIT'L HUSTLERS

\$1.49  
10 PK



# 2.5" LIT'L HUSTLERS \$1.89 - 10 PK



not actual size

# 1.5" CRAPPIE SHAD \$1.99-10 PK \$8.99-100 PK

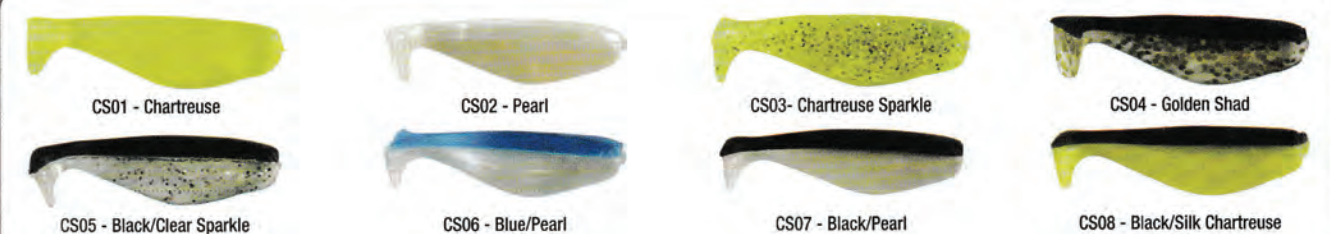

# 1.5" CORE LIT'L HUSTLERS

**\$2.99**  
**50 PK**



# 1.5" BI-COLOR LIT'L HUSTLERS

**\$1.89**  
**10 PK**

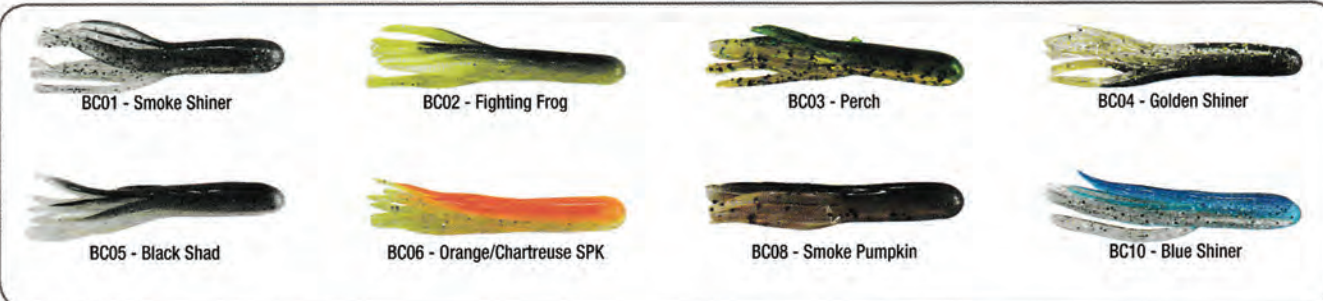

# 1.5" BREAM BUG

**\$8.99**  
**100 PK**

**\$1.09**  
**10 PK**

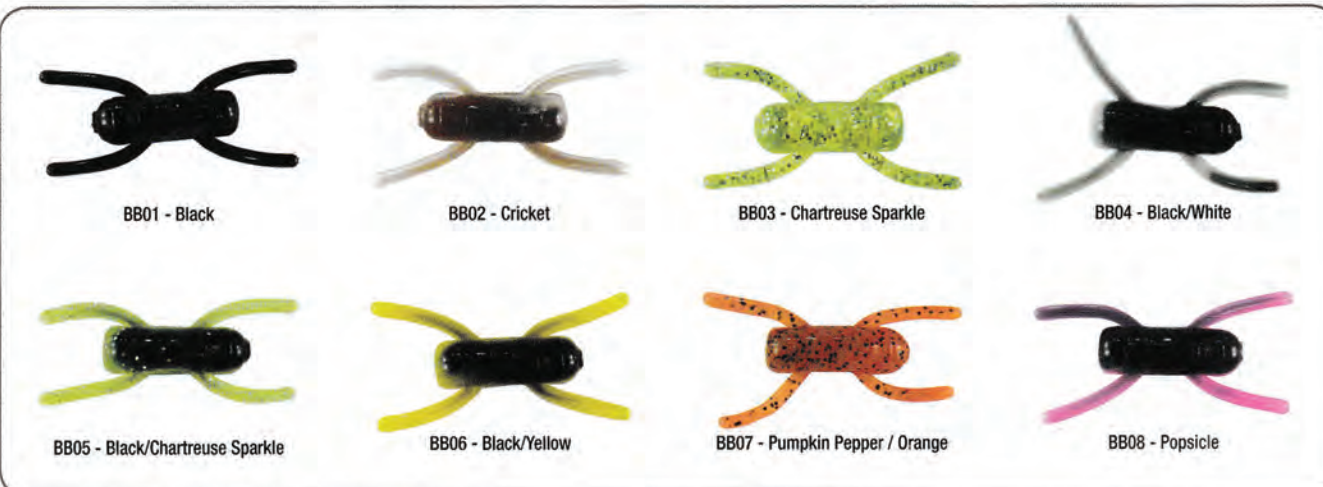

To Order: 1-800-305-9866

JIGS, SOFT BAITS, AND CRANK BAITS

# 2" STINGER SHAD

**\$3.29**  
**20 PK**



SS01 - Tennessee Shad



SS02 - Popsicle



SS03 - Blue Shiner



SS04 - Black/Blue/Chartreuse Sparkle



SS05 - Blue Storm



SS06 - Smokey Storm



SS07 - Black/Red/Chrt. Sparkle



SS08 - Pinky Shad



SS09 - Albino Shad



SS10 - Electric Chicken



SS11 - Blue Thunder



SS12 - Red Thunder



SS13 - Rainbow Shad



SS14 - Crystal Shad



SS15 - Blue Ice



SS16 - Bleeding Shad



SS17 - Chartreuse Shad



SS18 - Cajun Shad



SS19 - Blk. Shad/Firetail



SS20 - Pumpkin Shad



SS21 - Midnight Ghost



SS22 - Smurf Limeade



SS23 - Tiger Candy



SS24 - Bayou Booger



SS25 - Cajun Cricket



SS26 - Blue Thunder/Chartreuse



SS27 - Blue Thunder / Firetail



SS28 - Pink Panther



SS29 - Cajun Chicken



SS30 - Fred's Mistake



SS31 - Black Magic



SS40 - Monkey Milk

# 1" LIT'L HUSTLERS

**\$.99  
10 PK**



# 1" LIT'L HUSTLERS \$1.59 - 10 PK



To Order: 1-800-305-9866



**\$2.99**  
**6 PK.**



**HOT PINK**  
LJIG607-3/8OZ  
LJIG507-1/4OZ



**ORANGE**  
LJIG610-3/8OZ  
LJIG510-1/4OZ



**YELLOW/CHARTREUSE**  
LJIG612-3/8OZ  
LJIG512-1/4OZ



**BLACK/GREEN CHART**  
LJIG536-1/4OZ



**GREEN/YELLOW CHART**  
LJIG539-1/4OZ

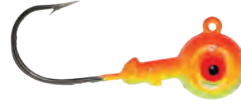

**ORANGE/YELLOW CHART**  
LJIG542-1/4OZ



**PINK/YELLOW CHART**  
LJIG540-1/4OZ

**Weed Guards**

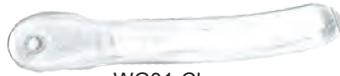

WG01-Clear



WG03-Black



WG05-Chartreuse



**\$0.99**  
**10 PK.**

**Pro Heads**

**Your Choice**  
**\$1.99**  
**10 pk.**

*Eagle Claw*  
*Platinum*  
*Hook*



Double Barb  
1/32, 1/16, 1/8, 1/4

**DCC32 1/32 oz.**  
**DCC16 1/16 oz.**  
**DCC18 1/8 oz.**  
**DCC14 1/4 oz.**

**\$1.99**  
**10 pk.**

**Teaser Double Barb Heads 3/32 oz.**



TH00 - Unpainted



TH01 - White



TH02 - Black



TH05 - Red



TH06 - Orange



TH07 - Chartreuse



TH03 - Yellow Chartreuse



TH04 - Pink

**Red Hot Minnow Head**

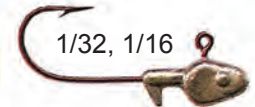

1/32, 1/16

**RHMH32-10**  
**RHMH16-10**  
**\$1.89/10 Pack**

**RHMH32-100**  
**RHMH16-100**  
**\$12.95/100 Pack**

**Crappie Wide Gap**

1/32, 1/16, 1/8

**RWG32-10**  
**RWG16-10**  
**RWG8-10**  
**\$1.99/10 PK**

**RWG32-50**  
**RWG16-50**  
**RWG8-50**  
**\$7.95/50 PK**



**Lightwire Jig Head**

**ITEM SIZE HOOK**  
**LWH- 1/32-10 #4**  
**LWH- 1/16-10 #2**  
**LWH- 1/8-10 #2**

**\$1.89**  
**10 pk.**



1/32, 1/16, 1/8



**\$12.95**  
**100 pk.**

**ITEM SIZE HOOK**  
**LWH- 1/32-100 #4**  
**LWH- 1/16-100 #2**  
**LWH- 1/8-100 #2**

**To Order: [www.grizzlyjig.com](http://www.grizzlyjig.com)**

### Leadheads

1/32 oz., 1/16 oz., and 1/8 oz.

 <b>RH - ROUND HEAD</b> 1/64 - 1/32 - 1/16 - 1/8 - 1/4	 <b>FL - FAST LOAD</b> 1/32 - 1/16 - 1/8 - 3/16	 <b>MH - MINNOW HEAD</b> 1/32 - 1/16 - 1/8
\$1.49/10 pk. \$10.95/100 pk. 1/4 oz-\$12.95/100 pk.	\$1.59/10 pk. \$12.95/100 pk.	\$1.49/10 pk. \$10.95/100 pk.

### Painted Heads

1/32 oz., 1/16 oz., and 1/8 oz.

 <b>PH01 - WHITE</b> 1/32 - 1/16 - 1/8	 <b>PH02 - BLACK</b> 1/32 - 1/16 - 1/8	 <b>PH03 - CHARTREUSE</b> 1/32 - 1/16 - 1/8
 <b>PH04 - PINK</b> 1/32 - 1/16 - 1/8	 <b>PH05 - RED</b> 1/32 - 1/16 - 1/8	
 <b>PH06 - BLUE</b> 1/32 - 1/16 - 1/8	 <b>PH08 - YEL/CHART</b> 1/32 - 1/16 - 1/8	 <b>PH07 - ORANGE</b> 1/32 - 1/16 - 1/8
\$1.89 10 PK.	\$16.95 100 PK. <i>BRONZE OR GOLD</i>	Also Available in 1/4 oz. 5 PK \$1.69 100 PK \$19.99

### Rattle Eye Jigheads Google Eyes









\$2.99  
6 PK.

\$10.99  
24 CT

 <b>RPH01 - WHITE</b> 1/32 - 1/16	 <b>RPH02 - BLACK</b> 1/32 - 1/16	 <b>RPH03 - CHARTREUSE</b> 1/32 - 1/16
 <b>RPH04 - PINK</b> 1/32 - 1/16	 <b>RPH05 - RED</b> 1/32 - 1/16	 <b>RPH06 - ORANGE</b> 1/32 - 1/16

### GRIZCO Splash Heads

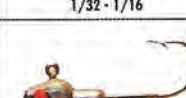
\$1.99  
10 PK.

 <b>MPH01 - BLACK/CHARTREUSE</b> 1/32 - 1/16	 <b>MPH02 - ORANGE/CHARTREUSE</b> 1/32 - 1/16
 <b>MPH04 - GREEN/CHARTREUSE</b> 1/32 - 1/16	 <b>MPH05 - RED/CHARTREUSE</b> 1/32 - 1/16
 <b>MPH07 - PINK/WHITE</b> 1/32 - 1/16	 <b>MPH08 - BLACK/GOLD</b> 1/32 - 1/16
 <b>MPH03 - BLACK/MINNOW SILVER</b> 1/32 - 1/16	 <b>MPH06 - CHARTREUSE/WHITE</b> 1/32 - 1/16

OUR STANDARD SIZE  
1/32 - #4 Hook  
1/16 - #2 Hook  
1/8 - #2 Hook

### WEEDLESS

\$1.59/5 pk.

#WRH-SIZE



Weedless Round Head  
1/32 - 1/16 - 1/8

1/32 - 1/16 - 1/8 oz.



#SRRH-10 \$1.89/10 pk.  
#SRRH-100 \$12.95/100 pk.



Red Hook

### Hot Heads

\$1.99 10 PK. 1/32, 1/16, or 1/8 oz.  
\$2.99 10 PK. 1/4 oz.

Hot heads feature Eagle Claw hooks and are available in 1/32 oz., 1/16 oz., 1/8 oz. and 1/4 oz.

 <b>HJ01 - Orange/Chartreuse</b>	 <b>HJ02 - Green/Chartreuse</b>	 <b>HJ03 - Black/Chartreuse</b>	 <b>HJ04 - Orange/Black</b>
 <b>HJ05 - Blue/Chartreuse</b>	 <b>HJ06 - Black/Silver</b>	 <b>HJ07 - Black/Yellow</b>	 <b>HJ08 - Pink/White</b>

To Order: 1-800-305-9866



# 1.5" Tiny Shad

15 Pk  
\$2.99

JIGS, SOFT BAIT, AND CRANK BAIT



Alewife  
SA01108/ 15 Ct.



Glow  
SA01116/ 15 Ct.



Limetreuse  
SA01118/ 15 Ct.



Texas Avocado  
SA01218/ 15 Ct.



Slammin' Chicken  
SA01265/ 15 Ct.



Black Shad  
SA01300/ 15 Ct.



Spring Minnow  
SA01315/ 15 Ct.



Albino Shad  
SA01330/ 15 Ct.



Arkansas Shiner  
SA01331/ 15 Ct.



Rainbow Trout  
SA01332/ 15 Ct.



Chartreuse Perch  
SA01334/ 15 Ct.



Gold Pepper Shiner  
SA01335/ 15 Ct.



Salt & Pepper Silver Phantom  
SA01336/ 15 Ct.



Meat Hook  
SA01338/ 15 Ct.



Pink/White Floater  
SA01340/ 15 Ct.



Chartreuse Pepper Shad  
SA01341/ 15 Ct.



Crystal Shad  
SA01343/ 15 Ct.



Pumpkinseed Shad  
SA01344/ 15 Ct.



Green Pumpkin/Gold  
SA01350/ 15 Ct.



Mississippi Hippie  
SA01352/ 15 Ct.



B-52  
SA01359/ 15 Ct.



Grasshopper  
SA01363/ 15 Ct.



Tomato Seed  
SA01364/ 15 Ct.



Orange/Gold Shiner  
SA01373/ 15 Ct.



Baby Bass  
SA01375/ 15 Ct.



Electric Chicken  
SA01376/ 15 Ct.



Opening Night  
SA01385/ 15 Ct.



Chartreuse Woodpecker  
SA01391/ 15 Ct.



Sunfish  
SA01392/ 15 Ct.



Silver Minnow  
SA01393/ 15 Ct.



Violet Moon  
SA01433/ 15 Ct.



Green Moon  
SA01435/ 15 Ct.



Chartreuse/Silver Glitter  
SA01452/ 15 Ct.



Rainbow Shad  
SA01462/ 15 Ct.



Albino Ghost  
SA01474/ 15 Ct.



Limetreuse Ghost  
SA01475/ 15 Ct.



Pink Ghost  
SA01476/ 15 Ct.



Natural Glow  
SA01509/ 15 Ct.



Orange Glow  
SA01511/ 15 Ct.



Blue Ice  
SA01522/ 15 Ct.



Limetreuse Glow  
SA01523/ 15 Ct.



Sugar & Spice  
SA01524/ 15 Ct.



Monkey Milk  
SA01527/ 15 Ct.



Monkey Storm  
SA01530/ 15 Ct.



Chico's Red Ear  
SA01540/ 15 Ct.



Purple Ice  
SA01541/ 15 Ct.



Texas Hippie  
SA01542/ 15 Ct.



## 2" Curly Shad

\$2.99  
10 PK



Alewife  
CSA35108/ 10 Ct.

Limetreuse  
CSA35118/ 10 Ct.

Slammin' Chicken  
CSA35265/ 10 Ct.

Black Shad  
CSA35300/ 10 Ct.

Candy Corn  
CSA35305 / 10 Ct.

Smokin' Shad  
CSA35314/ 10 Ct.

Albino Shad  
CSA35330/ 10 Ct.

Arkansas Shiner  
CSA35331/ 10 Ct.

Rainbow Trout  
CSA35332/ 10 Ct.

Salt & Pepper Silver Phantom  
CSA35336/ 10 Ct.

Chartreuse Pepper Shad  
CSA35341/ 10 Ct.

Crystal Shad  
CSA35343/ 10 Ct.

Pumpkinseed Shad  
CSA35344/ 10 Ct.

Orange/Gold Shiner  
CSA35373/ 10 Ct.

Pink Diamond  
CSA35374/ 10 Ct.

Electric Chicken  
CSA35376/ 10 Ct.

Fire Cracker  
CSA35414 / 10 Ct.

Violet Moon  
CSA35433/ 10 Ct.

Green Moon  
CSA35435/ 10 Ct.

Chartreuse/Silver Glitter  
CSA35452/ 10 Ct.

Limetreuse Ghost  
CSA35475/ 10 Ct.

Pink Ghost  
CSA35476/ 10 Ct.

Sugar & Spice  
CSA35524/ 10 Ct.

Chico's Red Ear  
CSA35540/ 10 Ct.

Texas Hippie  
CSA35542/ 10 Ct.

## 2" Pro Tiny Shad

15 PK  
\$2.99



Alewife  
PTS69108/ 15 Ct.

Black/Chartreuse tail  
PTS69205/ 15 Ct.

Chicken on a Chain  
PTS69214/ 15 Ct.

Pumpkinseed/Chartreuse Tail  
PTS69215/ 15 Ct.

Texas Avocado  
PTS69218/ 15 Ct.

Salt & Pepper Silver Phantom/  
Chartreuse Tail  
PTS69238/ 15 Ct.

Fire Tiger  
PTS69245/ 15 Ct.

Pearl/Chartreuse Tail  
PTS69256/ 15 Ct.

Slammin' Chicken  
PTS69265/ 15 Ct.

Pink/Chartreuse Tail  
PTS69269/ 15 Ct.

Lime/Orange Tail  
PTS69270/ 15 Ct.

Blue Thunder/Chartreuse Tail  
PTS69271/ 15 Ct.

Monkey Milk/Chartreuse Tail  
PTS69272/ 15 Ct.

Black Shad  
PTS69300/ 15 Ct.

Spring Minnow  
PTS69315/ 15 Ct.

Albino Shad  
PTS69330/ 15 Ct.

Salt & Pepper Silver Phantom  
PTS69336/ 15 Ct.

Electric Chicken  
PTS69376/ 15 Ct.

Limetreuse Ghost  
PTS69475/ 15 Ct.

Pink Ghost  
PTS69476/ 15 Ct.

Blue Thunder  
PTS69518/ 15 Ct.

Key Lime Pie  
PTS69519/ 15 Ct.

Silk Chartreuse  
PTS69520/ 15 Ct.

Blue Grass  
PTS69521/ 15 Ct.

Blue Ice  
PTS69522/ 15 Ct.

Limetreuse Glow  
PTS69523/ 15 Ct.

Chartreuse White  
PTS69526/ 15 Ct.

Monkey Milk  
PTS69527/ 15 Ct.

Dreamsicle  
PTS69528/ 15 Ct.

Lime Green  
PTS69529/ 15 Ct.

# Super Jigs By Mid-South Tackle

\$1.99  
18PK



100 PEARL



102 WHITE/CLEAR SPK



103 WHITE/CLEAR PEPPER



104S WHITE/BLUE SPK



106 WHITE/PINK



108 WHITE/CHART



108S WHITE/CHART SPK



110 PEARL/RED



111 PEARL/BLUE



116 BACON GLO



120 WHITE



200 RED/PEARL



201 RED/YELLOW



202 RED/CHART



203 RED/CLEAR SPK



210 RED/CHART SPK



211 RED/CHART/GN FLK



220 RED/CHART/RED FLK



301 YELLOW/PEARL



302 YELLOW/CHART



310 YELLOW/CHART SPK



311 YELLOW/CHART/GN FLK



400 BLACK SPK



401 BLACK/PEARL



402 BLACK/YELLOW



403 BLACK/FLO GREEN



404 BLACK/CHART



404B BLACK/CHART PEPPER



405 BLACK/RED



406 BLACK/HOT PINK SPK



407 BLACK/CLEAR SPK



409 BLACK/ORNG PEPPER



410 BLACK/CHART SPK

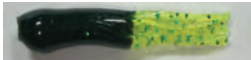

411 BLACK/CHART/GN FLK



412 BLACK/BLUE SPK



416 MCCLURE'S MU



420 BLACK/CHART/RED FLK



501 PURPLE/PEARL



502 GRAPE/CLEAR SPK



503 GRAPE/CHART



507 PURPLE/ORANGE



516 PRETTY GIRL



517 DEPOT



580 JUNEBUG/CHART SPK



530 PURPI F/CHART



600 HOT PINK SPK



600N PINK NEON



602 PINK/CLEAR SPK



603 PINK/CHART



603S ELECTRIC CHICKEN



620 PINK/WHITE



700N ORANGE NEON



701 ORANGE/PEARL



703 ORANGE/CLEAR SPK



710 ORANGE/CHART SPK



800 CHARTREUSE



800B CHART PEPPER



800BC ORANGE/CHART PEP



800RC CHART/RAINBOW CORE



801 CHART/PEARL



802 CHART/CLEAR SPK



810 CHART/GN FLK

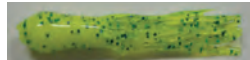

811 CHART/BL FLK OVER WHITE



820C CHART/RED FLK CORE



900 BROWN/PEARL



901 BROWN/ORANGE



902 BROWN/CHART SPK



911 PUMPKIN PEP/GN FLK



920 WINE/CHART



1000 CHART SPK



1002 BLUE/CHART



1003 BLUE/CLEAR SPK



1004 PALE BLUE/PEARL



1005 BLUE/FLO GREEN



1010 GREEN/CHART SPK



1016 OKER BLUE



1050 BURPLE

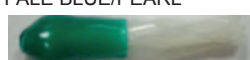

1101 GREEN/PEARL

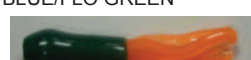

1102 GREEN/ORANGE



1103 FLO GN/CLEAR SPK



1105 GREEN/CHART



1106 GREEN/PINK



1107 BULLFROG



1180 RED PEPPER/SILK CHART



1200 SMOKE SPK



1201 SMOKE/RED BLACK



1202 SMOKE NEON WITH CHART CORE

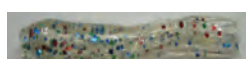

1301 CLEAR FIRECRACKER

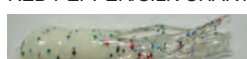

1301C CLR FIRECRACKER CORE



1303 SAND (GRASS SHRIMP)

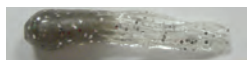

1500 SILVER/CLR SPK



1508 SILVER/CHART



2017 CM CLASSIC



2018 WYATT'S TUBE



5108 CRAPPIEHOLIC



10095 ICE MONTELEONE

## Super Jigs Glow Skirts By Mid-South Tackle

\$1.99  
18 PK

Glow Skirts are also available in 2 3/4". For a 15 pk, add "2" to the Item #.

(For example: 100GL-2) Pro Series \$2.99/15 PK

The Super Jig tube skirts are 1 3/4" long. A little longer than your regular crappie tubes, with some of the most brilliant colors I've seen. A little more expensive, but well worth the money.



100GL PEARL GLOW



200GL RED/PEARL GLOW



202GL RED/CHART GLOW



302GL YELLOW/CHART GLOW



404GL BLACK/CHART GLOW



601GL PINK/PEARL GLOW



702GL ORANGE/CHART GLOW



800GL CHARTREUSE GLOW



902GL BROWN/CHART GLOW



1001GL BLUE/PEARL GLOW



1105GL GREEN/CHART GLOW



10012GL PILLSBURY GLOW



1201GL SMOKE GLOW



406GL BLACK/PINK GLOW



516GL Pretty Girl Glo



0015GL LIME GLOW

## Glitter Head Skirts By Mid-South Tackle

\$1.99  
18 PK



212 RED GLITTER/SMOKE



2012 RED GLITTER/CHART



4012 BLACK GLITTER/CHART



512 PURPLE GLITTER/CHART



612 PINK GLITTER/CHART



712 ORANGE GLITTER/CHART



812 SILVER GLITTER/CHART



1012 BLUE GLITTER/CHART



1512 SILVER GLITTER/PEARL GLOW



813 FIRECRACKER GLITTER/CHART



1112 GREEN GLITTER/CHART



10812 WHITE GLITTER/CHART



011 PUTNAM GREEN/CLEAR



0095 MONTELEONE SILVER



716 GOLD GLITTER W/ ORANGE



8016GL CHART GLITTER/PRL GLO



816 GOLD GLITTER W/ CHART



617 PINK GLITTER/ORANGE



486 BLK & CHART GLITTER PINK



1070 BLUE GLITTER/ORANGE



1116 GOLD GLITTER W/ GREEN



2020 SILVER GLITTER W/ FLO PINK

To Order: 1-800-305-9866



# Dead Ringers

## Crappie Series

- Solid Bodies
- Super Scent Holding Ring to Entrap and Hold Attractant Longer
- High Quality Precision Plastic
- Brilliant No Bleed Colors

### 2" Dead Ringer Stingers

\$2.99 - 20 ct DRS-# \_\_\_\_\_

-  Red/Pearl 01
-  Pearl 04
-  Chartreuse Sparkle 05
-  Blue/Pearl 06
-  Red/Chartreuse Sparkle 70
-  Black/Chartreuse Sparkle 72
-  Pearl/Chartreuse/Hot Pink 80
-  Hot Orange/Hot Pink 81
-  Hot Pink/Pearl/Chartreuse 82
-  Hot Pink/Hot Orange 83
-  White/Chartreuse Sparkle 97
-  Cajun Cricket 98



### 2" Dead Ringer Crappie Crickets

\$2.99 - 20 ct DRCC-# \_\_\_\_\_

-  Blue/Pearl 02
-  Red/Pearl 03
-  Black/Pearl 04
-  Pearl 05
-  Chart. Sparkle 06
-  Black/Chart. Spk. 07
-  Red/Chart. Spk. 09
-  Punkin Pepper 24
-  Hot Ora./Hot Pk. 81
-  Pum. Pep. Pearl/Chartreuse 72



Hot Pk./Pearl/Chartreuse 82



Cajun Cricket 98



Hot Pk./Hot Orange 83



Pearl/Chartreuse/Hot Pink 80

To Order: [www.grizzlyjig.com](http://www.grizzlyjig.com)



# Dead Ringers

## Crow's Feet

2" Dead Ringer Crow's Feet

DRCT-#\_\_\_\_

**\$2.99 - 20 ct**

- Solid Bodies
- Super Scent Holding Ring to Entrap and Hold Attractant Longer
- Long 1" Feet



Chartreuse Sparkle 05



Hot Pink/Pearl Chartreuse 82



Blue/Pearl 06



White/Chartreuse Sparkle 97



Red/Chartreuse Sparkle 70



Cajun Cricket 98



Black/Chartreuse Sparkle 72



Blue/Pearl Chartreuse 99

# MR. CRAPPIE Slab Daddy<sup>®</sup> Super Finesse Jigs

4 PK  
\$3.59

SD2-# \_\_\_ 1/16 oz.  
SD3-# \_\_\_ 1/8 oz.



#701  
"Snowballs"



#711  
"Parrot Head"



#743  
"Fake Bait"



#744  
"Shell Cracker"



#752  
"Pink Pearl"



#738  
"Electric Chicken"



#733  
"White Perch"



#730  
"Classic"



#751  
"Pank"



#765  
"Candy Cane"

### Mr. Crappie Troll-Tech Crappie Rigs complete with hooks and leaders



Item	Size	Pk	Price
MCCR12	1/2 oz.	2	\$4.99
MCCR34	3/4 oz.	2	\$4.99
MCCR1	1 oz.	2	\$4.99

To Order: 1-800-305-9866

•Double Dotted  
Glo-Ring Eyes

# Dead Ringer Glo-Heads

•Extra  
Sharp  
Jig Hook

**\$3.99**  
20 ct



**Glo-Yellow Chartreuse**  
1/32 oz....DRGH-32Y  
1/16 oz....DRGH-16Y  
1/8 oz....DRGH-18Y



**Glo-Orange**  
1/32 oz....DRGH-32O  
1/16 oz....DRGH-16O  
1/8 oz....DRGH-18O



**Glo-Pink**  
1/32 oz....DRGH-32P  
1/16 oz....DRGH-16P  
1/8 oz....DRGH-18P

**25 PK**  
**\$3.49**  
(Add -25 to Item #)

## SPECIAL BUY Double Barbed Jig Heads

5 Colors



**100 PK**  
**\$12.95**  
(Add -100 to Item #)  
2 Sizes  
1/32 - #6  
1/16 - #4

SIZE	WHITE	BLACK	PINK	ORANGE	RED
1/32 oz	GJC-DBJ-32W-__	GJC-DBJ-32B-__	GJC-DBJ-32P-__	GJC-DBJ-32O-__	GJC-DBJ-32R-__
1/16 oz	GJC-DBJ-16W-__	GJC-DBJ-16B-__	GJC-DBJ-16P-__	GJC-DBJ-16O-__	GJC-DBJ-16R-__

## Garrett Outdoors

Red Sickle Hooks with Painted Heads

**\$6.99**  
**25 PK**

1/32 oz-#4 Hook		1/16 oz-#2 Hook		1/8 oz-#4 Hook	
GAR32R	RED	GAR16R	RED	GAR18R	RED
GAR32O	ORANGE	GAR16O	ORANGE	GAR18O	ORANGE
GAR32B	BLACK	GAR16B	BLACK	GAR18B	BLACK
GAR32W	WHITE	GAR16W	WHITE	GAR18W	WHITE
GAR32C	CHARTREUSE	GAR16C	CHARTREUSE	GAR18C	CHARTREUSE
GAR32YC	YELLOW/CHART	GAR16YC	YELLOW/CHART	GAR18YC	YELLOW/CHART
GAR32P	PINK	GAR16P	PINK	GAR18P	PINK
GAR32SF	SILVER FLAKE	GAR16SF	SILVER FLAKE	GAR18SF	SILVER FLAKE
GAR32GF	GOLD FLAKE	GAR16GF	GOLD FLAKE	GAR18GF	GOLD FLAKE
GAR32CHF	CHART FLAKE	GAR16CHF	CHART FLAKE	GAR18CHF	CHART FLAKE



To Order: [www.grizzlyjig.com](http://www.grizzlyjig.com)

**Muddy Water  
Custom Crappie  
Baits**

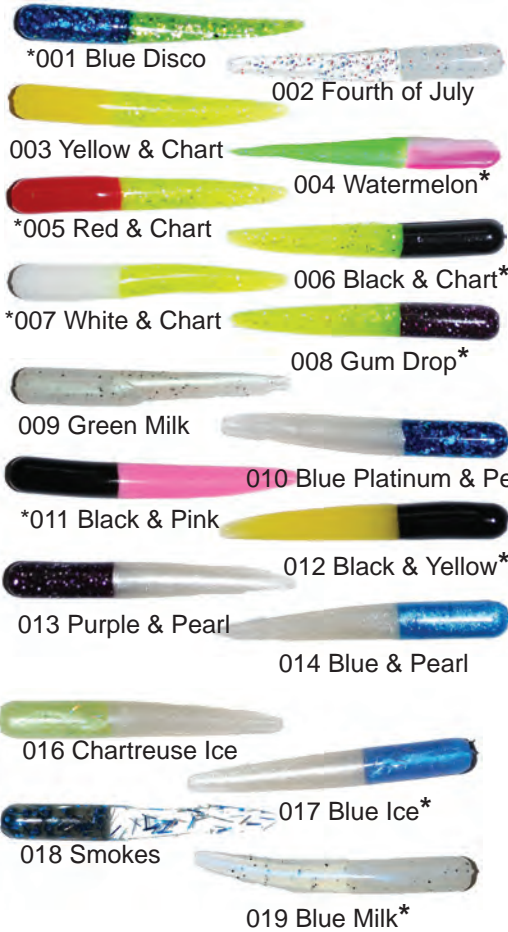

2-1/4" Solid Body  
& Tail w/ Garlic  
#MW        
color

**\$2.99  
12 PK**



**\*Available in 2"**  
#2MW        
color



FROM:  
Bullet  
Weights

ADD-A-HOOK



MCAH 10PK \$4.69

**Mr. Crappie Double Down Rig**

Item	Size	Pk	Price
MCDDR14	1/4 oz.	3	\$7.99
MCDDR38	3/8 oz.	3	\$7.99
MCDDR12	1/2 oz.	3	\$7.99
MCDDR34	3/4 oz.	3	\$7.99

**Mr. Crappie Crankbait Down Riggers**

Item	Size	Pk	Price
MCCBDR2	2 oz.	2	\$3.49
MCCBDR3	3 oz.	2	\$3.49

**Mr. Crappie Slo-Troll Rig**

Item	Size	Pk	Price
MCSTR14	1/4 oz.	3	\$7.99
MCSTR38	3/8 oz.	3	\$7.99
MCSTR12	1/2 oz.	3	\$7.99
MCSTR34	3/4 oz.	3	\$7.99

To Order: 1-800-305-9866



# 1-1/2" Crappie/Panfish Slider Grubs

Actual Size



- |  |   |  |  |
|--|---|--|--|
| <p><b>CSGG88</b> - Avocado</p> <p><b>CSG1</b> - Black</p> <p><b>CSG4</b> - White</p> <p><b>CSG5</b> - Chartreuse</p> <p><b>CSG5M</b> - Chartreuse Multi Glitter</p> <p><b>CSG13</b> - Motor Oil Red Glitter</p> <p><b>CSG33</b> - Pearl</p> <p><b>CSG36</b> - Funky Monkey</p> <p><b>CSG56</b> - Blue/Chartreuse</p> <p><b>CSG815</b> - Watermelon Seed</p> <p><b>CSG4F3-GLO</b> - White/Pink Glow Tail</p> <p><b>CSG7168</b> - Blue Gill</p> <p><b>CSGC128</b> - Char/June Bug Core</p> <p><b>CSGF3</b> - Pink Pearl Tail</p> <p><b>CSGF05</b> - Gold Glitter/Chartreuse</p> <p><b>CSGF5</b> - Black/Chartreuse</p> <p><b>CSGF6</b> - Blue Ice/Chartreuse</p> <p><b>CSGF8</b> - Pearl Green/Silver Glitter</p> <p><b>CSGF9</b> - Red/Chartreuse</p> <p><b>CSGF10</b> - Mustang Black/Gold/Char</p> <p><b>CSGF13</b> - Motor Oil Glitter/Orange Tail</p> <p><b>CSGF17</b> - Pumpkin Black/Chartreuse</p> <p><b>CSGF30</b> - Hot Pink/Silver Glitter Tail</p> <p><b>CSGF45</b> - White/Chartreuse</p> <p><b>CSGF46</b> - White/Blue</p> <p><b>CSGF51</b> - Creamy Green/Black</p> <p><b>CSGF59</b> - Chartreuse Glitter/Red</p> <p><b>CSGF85</b> - Grasshopper</p> <p><b>CSGF88</b> - Avocado/Chartreuse</p> <p><b>CSGF318</b> - Baby Bass/Chartreuse Tail</p> <p><b>CSGF335</b> - Bubble Gum/Chartreuse Tail</p> <p><b>CSGF368</b> - Cotton Candy/Chartreuse Tail</p> <p><b>CSGF615</b> - Rainbow Orange</p> <p><b>CSGF2506</b> - Wild Cat/Blue Tail</p> <p><b>CSGFGLO</b> - Black/Glow Tail</p> <p><b>CSGFL185</b> - Star Dust/Chartreuse</p> | <p><b>CSG17</b> - Black</p> <p><b>CSGG88</b> - Avocado</p> <p><b>CSGG368</b> - Cotton Candy</p> <p><b>CSGG8171</b> - Green Pumpkin/Black</p> <p><b>CSGGF15</b> - Chartreuse Black/Orange</p> <p><b>CSGGF55</b> - Lemonade</p> <p><b>CSGGF128</b> - June Bug/Chartreuse</p> <p><b>CSGGLO</b> - Glow</p> <p><b>CSGL28</b> - Muscadine</p> <p><b>CSGL148</b> - Caterpillar</p> <p><b>CSGL163</b> - Tennessee Shad</p> <p><b>CSGL148</b> - Caterpillar</p> <p><b>CSGL163</b> - Tennessee Shad</p> <p><b>CSGL103</b> - Brown Pearl</p> | <p><b>CSGFL2210</b> - Craw Fish</p> <p><b>CSGFLCDY</b> - Candy Corn</p> <p><b>CSGG226</b> - TN Blue Glitter</p> <p><b>CSGG5</b> - Chartreuse Glitter</p> <p><b>CSGG7</b> - Smoke Glitter</p> <p><b>CSGG8</b> - Green Gold Glitter</p> <p><b>CSGG17</b> - Pumpkin Black Flake</p> <p><b>CSGG88</b> - Avocado</p> <p><b>CSGG368</b> - Cotton Candy</p> <p><b>CSGG8171</b> - Green Pumpkin/Black</p> <p><b>CSGGF15</b> - Chartreuse Black/Orange</p> <p><b>CSGGF55</b> - Lemonade</p> <p><b>CSGGF128</b> - June Bug/Chartreuse</p> <p><b>CSGGLO</b> - Glow</p> <p><b>CSGL28</b> - Muscadine</p> <p><b>CSGL148</b> - Caterpillar</p> <p><b>CSGL163</b> - Tennessee Shad</p> <p><b>CSG814</b> - Deer John</p> <p><b>CSGLF1445</b> - Acid Rain</p> <p><b>CSGLG15</b> - Orange/Chartreuse</p> <p><b>CSGC89</b> - Chart Red Core</p> <p><b>CSGL103</b> - Brown Pearl</p> | <p><b>CSG815</b> - Watermelon Seed</p> <p><b>CSG4F3-GLO</b> - White/Pink Glow Tail</p> <p><b>CSG7168</b> - Blue Gill</p> <p><b>CSGC128</b> - Char/June Bug Core</p> <p><b>CSGF3</b> - Pink Pearl Tail</p> <p><b>CSGF05</b> - Gold Glitter/Chartreuse</p> <p><b>CSGF5</b> - Black/Chartreuse</p> <p><b>CSGF6</b> - Blue Ice/Chartreuse</p> <p><b>CSGF8</b> - Pearl Green/Silver Glitter</p> <p><b>CSGF9</b> - Red/Chartreuse</p> <p><b>CSGF10</b> - Mustang Black/Gold/Char</p> <p><b>CSGF13</b> - Motor Oil Glitter/Orange Tail</p> <p><b>CSGF17</b> - Pumpkin Black/Chartreuse</p> <p><b>CSGF30</b> - Hot Pink/Silver Glitter Tail</p> <p><b>CSGF45</b> - White/Chartreuse</p> <p><b>CSGF46</b> - White/Blue</p> <p><b>CSGF51</b> - Creamy Green/Black</p> <p><b>CSGF59</b> - Chartreuse Glitter/Red</p> <p><b>CSGF85</b> - Grasshopper</p> <p><b>CSGF88</b> - Avocado/Chartreuse</p> <p><b>CSGF318</b> - Baby Bass/Chartreuse Tail</p> <p><b>CSGF335</b> - Bubble Gum/Chartreuse Tail</p> <p><b>CSGF368</b> - Cotton Candy/Chartreuse Tail</p> <p><b>CSGF615</b> - Rainbow Orange</p> <p><b>CSGF2506</b> - Wild Cat/Blue Tail</p> <p><b>CSGFGLO</b> - Black/Glow Tail</p> <p><b>CSGFL185</b> - Star Dust/Chartreuse</p> <p><b>CSGFL2210</b> - Craw Fish</p> <p><b>CSGG5</b> - Chartreuse Glitter</p> <p><b>CSGG7</b> - Smoke Glitter</p> <p><b>CSGG8</b> - Green Gold Glitter</p> <p><b>CSGG17</b> - Pumpkin Black Flake</p> <p><b>CSGG88</b> - Avocado</p> <p><b>CSGG368</b> - Cotton Candy</p> <p><b>CSGG8171</b> - Green Pumpkin/Black</p> <p><b>CSGGF15</b> - Chartreuse Black/Orange</p> <p><b>CSGGF55</b> - Lemonade</p> <p><b>CSGGF128</b> - June Bug/Chartreuse</p> <p><b>CSGGLO</b> - Glow</p> <p><b>CSGL28</b> - Muscadine</p> <p><b>CSGL148</b> - Caterpillar</p> <p><b>CSGL163</b> - Tennessee Shad</p> <p><b>CSG814</b> - Deer John</p> <p><b>CSGLF1445</b> - Acid Rain</p> <p><b>CSGLG15</b> - Orange/Chartreuse</p> <p><b>CSGC89</b> - Chart Red Core</p> <p><b>CSGL103</b> - Brown Pearl</p> <p><b>CSGF36</b> - Funky Monkey</p> <p><b>CSGF56</b> - Starlight</p> <p><b>CSGG00</b> - Clear Hologram</p> <p><b>CSGF94</b> - Red/White</p> <p><b>CSGG1289</b> - Camouflage</p> <p><b>CSGFL38</b> - Chicken</p> <p><b>CSGFL30</b> - Pink Ice</p> <p><b>CSGL893</b> - Green Ghost</p> <p><b>CSGF103</b> - Pumpkin/Pink</p> |
|--|---|--|--|

**\$2.99**  
**18 pk**



To Order: [www.grizzlyjig.com](http://www.grizzlyjig.com)



# 2-1/8" Double Action Minnow

Great for Bass - Crappie - Panfish

**\$2.99**  
**10 PK**



**SMF368**  
Cotton Candy Chartreuse

This new grub minnow is the same design as the 3" Double Action Grub but in a 2 1/8" length. You get the same vibra-tail action and wave movement as the longer model just in a smaller package to appeal to crappie and panfish as well as bass.



COLOR SAMPLES SHOWN AT REDUCED SIZE



- SMGF55** - Lemonade
- SMGF128** - June Bug Minnow
- SM145** - Yellowbelly
- SMF3** - Pink Pearl
- SMF6** - Blue Ice/Chartreuse
- SMF12** - Black/Purple Tail
- SMF45** - White Chartreuse
- SMF62** - Blue Glitter/Purple Tail

- SMF85** - Grasshopper
- SMF88** - Avocado Chartreuse
- SMF368** - Cotton Candy Chartreuse
- SMG74** - Silver Blue
- SMG89** - Watermelon/Red/  
Copper/Black Flake
- SMF5** - Black/Chartreuse
- SMGF15** - Chartreuse Orange

- SML103** - Brown Pearl
- SMFGLO** - Black Glo Tail
- SMGFL38** - Chicken
- SMGFL185** - Stardust
- NEW** **SMFGFL1445** - Acid Rain
- NEW** **SMF3-GLO** - White/Pink Glo
- NEW** **SML893** - Green Ghost
- NEW** **SMF65** - Creamy Blue/Chartreuse
- NEW** **SMF35** - Florescent Orange/ Chart

# Slider Weedless Crappie Slider Head



Available in 4 colors: orange, black, chartreuse, and red.  
Size 1 hook 1 1/2" Long

**\$2.79**  
**ea.**

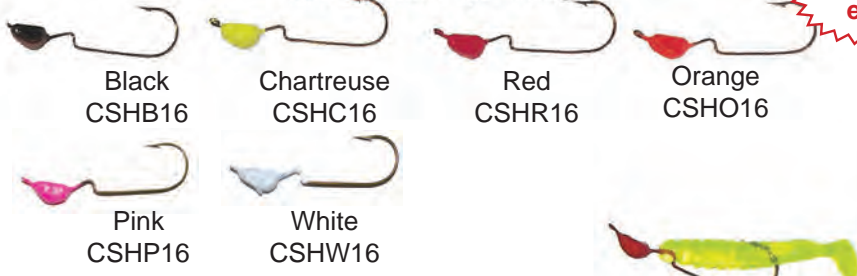

Black CSHB16    Chartreuse CSHC16    Red CSHR16    Orange CSHO16  
Pink CSHP16    White CSHW16

**1/16 oz. 4 Pack \$2.69**



Charlie Brewer, Jr.

To Order: 1-800-305-9866

JIGS, SOFT BAITS, AND CRANK BAITS



# BOBBY GARLAND CRAPPIE BAITS

JIGS, SOFT BAITS, AND CRANK BAITS

**1.25" ITTY BIT SWIM'R** With a name longer than its length, this tiny Swim'R starts every day with a chip on its shoulders to prove it can catch them big and small year 'round. 20-count bag.

**\$3.29**

- |                                     |   |                         |
|-------------------------------------|---|-------------------------|
| IBS43 MO' GLO GHOST SPARKLE         | IBS196 NATURAL CRICKET (LAM)              | IBS325 PENNY BACK (LAM) |
| IBS65 PEARL WHITE                   | IBS203 MONKEY MILK                        | IBS326 ICE OUT (LAM)    |
| IBS128 MO' GLO BLUE GHOST (LAM)     | IBS206 KEY LIME PIE (LAM)                 | IBS327 ECLIPSE (LAM)    |
| IBS142 BLUE THUNDER (LAM)           | IBS219 ELECTRIC CHICKEN (LAM)             | IBS336 BLUE ICE (LAM)   |
| IBS148 CRYSTAL (LAM)                | IBS249 MO' GLO ELECTRIC CHICKEN GLO (LAM) | IBS349 BLACK CRICKET    |
| IBS149 CHARTREUSE RED GLITTER (LAM) |   | IBS350 TADPOLE (LAM)    |
| IBS181 BLUEGRASS (LAM)              | IBS284 MO' GLO SCREAMER (LAM)             | IBS370 MAYFLY (LAM)     |
| IBS187 MO' GLO OUTLAW SPECIAL (LAM) | IBS311 LIGHTS OUT! (LAM)                  | IBS371 MIDGE (LAM)      |
| IBS195 CAJUN CRICKET (LAM)          | IBS313 GLACIER                            |                         |



MAYFLY (370)

Refer to Swim'R color chart below.

**2.25" BABY SHAD SWIM'R** A segmented swimming version of America's favorite crappie bait – the Baby Shad – featuring a tight-action swim tail and a special Scent Channel in the belly for optional scent application. 15-count bag.

**\$3.29**

- |                                      |  |                                  |                                      |
|--------------------------------------|--|----------------------------------|--------------------------------------|
| BSSW43 MO' GLO GHOST SPARKLE         | BSSW203 MONKEY MILK                        | BSSW327 ECLIPSE (LAM)            | BSSW378 GREEN BANANA (LAM)           |
| BSSW65 PEARL WHITE                   | BSSW206 KEY LIME PIE (LAM)                 | BSSW329 GLITTER CRITTER (LAM)    | BSSW379 NEON PRISM (LAM)             |
| BSSW128 MO' GLO BLUE GHOST (LAM)     | BSSW219 ELECTRIC CHICKEN (LAM)             | BSSW336 BLUE ICE (LAM)           | BSSW380 PURPLE PASSION (LAM)         |
| BSSW142 BLUE THUNDER (LAM)           | BSSW249 MO' GLO ELECTRIC CHICKEN GLO (LAM) | BSSW346 SWEET TEA W/ LEMON (LAM) | BSSW382 INDIGO SKY (LAM)             |
| BSSW143 BLEEDING SHAD (LAM)          |  | BSSW347 PINK LEMONADE (LAM)      | BSSW383 MO' GLO THE SHADOW (LAM)     |
| BSSW148 CRYSTAL (LAM)                | BSSW284 MO' GLO SCREAMER (LAM)             | BSSW348 BLUEBACK SHAD (LAM)      | BSSW384 MO' GLO GREEN LANTERN (LAM)  |
| BSSW149 CHARTREUSE/RED GLITTER (LAM) | BSSW311 LIGHTS OUT! (LAM)                  | BSSW350 TADPOLE (LAM)            | BSSW385 MO' GLO MONKEY MILK GLO      |
| BSSW150 LICORICE/CHART PEARL (LAM)   | BSSW312 FULL MOON                          | BSSW369 LIVE MINNOW (LAM)        | BSSW388 MUD DAUBER                   |
| BSSW181 BLUEGRASS (LAM)              | BSSW313 GLACIER                            | BSSW370 MAYFLY (LAM)             | BSSW389 PURPLE MONKEY                |
| BSSW183 PATRIOT (LAM)                | BSSW318 GLO BOY (LAM)                      | BSSW371 MIDGE (LAM)              | BSSW390 BLOOD MINNOW                 |
| BSSW187 MO' GLO OUTLAW SPECIAL (LAM) | BSSW319 FIRST LIGHT (LAM)                  | BSSW372 MO' GLO SUNSET (LAM)     | BSSW391 COPPERNOSE                   |
| BSSW191 THREADFIN SHAD (LAM)         | BSSW325 PENNY BACK (LAM)                   | BSSW376 BLUE CHROME (LAM)        | BSSW1905 BONE WHITE/CHARTREUSE (LAM) |
| BSSW195 CAJUN CRICKET (LAM)          | BSSW326 ICE OUT (LAM)                      | BSSW377 DIAMOND MIST (LAM)       |                                      |



The Itty Bit and Baby Shad Swim'Rs have a Scent Channel under the belly for optional application of Mo'Glo Slab Jam or other scents.



## BABY SHAD - MO' GLO COLORS



To Order: [www.grizzlyjig.com](http://www.grizzlyjig.com)

# BOBBY GARLAND CRAPPIE BAITS



JIGS, SOFT BAITS, AND CRANK BAITS

**2" BABY SHAD** Just try to hold this bait so the tail doesn't dance. You can't and that's why this bait catches more fish. 18-count bag.

**\$3.29**

- BS33 CHARTREUSE SILVER
- BS63 PEARL CHARTREUSE
- BS65 PEARL WHITE
- BS92 SMOKE SILVER
- BS123 BABY BASS (LAM)
- BS141 CHART/BLACK PEPPER (LAM)
- BS142 BLUE THUNDER (LAM)
- BS143 BLEEDING SHAD (LAM)
- BS144 BLUE PEARL (LAM)
- BS145 HOLOGRAM GHOST (LAM)
- BS146 KIWI (LAM)
- BS147 RED THUNDER (LAM)
- BS148 CRYSTAL (LAM)
- BS149 CHARTREUSE/RED GLITTER (LAM)
- BS150 LICORICE/CHART PEARL (LAM)
- BS151 PINK PEARL (LAM)
- BS152 RAINBOW (LAM)
- BS153 DOUBLE SILVER RAINBOW
- BS154 EMERALD SHAD (LAM)
- BS158 BABY CRAWDAD (LAM)
- BS159 PURPLE MIST (LAM)
- BS177 GUMDROP (LAM)
- BS179 HOT LIPS

- BS181 BLUEGRASS (LAM)
- BS182 BLACK GUM (LAM)
- BS183 PATRIOT (LAM)
- BS188 GREEN THUNDER (LAM)
- BS191 THREADFIN SHAD (LAM)
- BS194 GREEN TOMATO (LAM)
- BS195 CAJUN CRICKET (LAM)
- BS196 NATURAL CRICKET (LAM)
- BS200 ALBINO SHAD (LAM)
- BS201 BUTTER BELLY (LAM)
- BS202 BAYOU BOOGER (LAM)
- BS203 MONKEY MILK
- BS204 VEGAS (LAM)
- BS206 KEY LIME PIE (LAM)
- BS219 ELECTRIC CHICKEN (LAM)
- BS222 OPENING NIGHT (LAM)
- BS279 HALO (LAM)
- BS280 SHIMMER SHAD
- BS281 GREEN HORNET (LAM)
- BS295 TUXEDO SHIMMER (LAM)
- BS296 DREAMSICLE DELIGHT (LAM)
- BS297 BLACK NIGHT
- BS298 BBQ CHICKEN (LAM)

- BS305 WATERMELON WINE (LAM)
- BS311 LIGHTS OUT (LAM)
- BS312 FULL MOON
- BS313 GLACIER
- BS325 PENNY BACK (LAM)
- BS326 ICE OUT (LAM)
- BS327 ECLIPSE (LAM)
- BS329 GLITTER CRITTER (LAM)
- BS336 BLUE ICE (LAM)
- BS346 SWEET TEA W/ LEMON (LAM)
- BS347 PINK LEMONADE (LAM)
- BS348 BLUEBACK SHAD (LAM)
- BS350 TADPOLE (LAM)
- BS369 LIVE MINNOW (LAM)
- BS370 MAYFLY (LAM)

- BS371 MIDGE (LAM)
- BS376 BLUE CHROME (LAM)
- BS377 DIAMOND MIST (LAM)
- BS378 GREEN BANANA (LAM)
- BS379 NEON PRISM (LAM)
- BS380 PURPLE PASSION (LAM)
- BS382 INDIGO SKY (LAM)
- BS388 MUD DAUBER
- BS389 PURPLE MONKEY
- BS390 BLOOD MINNOW
- BS391 COPPERNOSE
- BS0364 BLACK/HOT PINK (LAM)
- BS1809 RED/CHARTREUSE SILVER (LAM)
- BS1905 BONE WHITE/CHARTREUSE (LAM)



BBQ CHICKEN (298)

## BABY SHAD - COLORS

ALBINO SHAD (200)	*BLUE THUNDER (142)	FULL MOON (312)	*LICORICE/CHARTREUSE PEARL (150)	PINK PEARL (151)
BABY BASS (123)	BONE WHITE/CHAR. (1905)	GLACIER (313)	LIGHTS OUT (311)	PURPLE MIST (159)
BABY CRAWDAD (158)	BUTTER BELLY (201)	GLITTER CRITTER (329)	LIVE MINNOW (369)	PURPLE MONKEY (390)
BAYOU BOOGER (202)	CAJUN CRICKET (195)	GREEN BANANA (378)	MAYFLY (370)	PURPLE PASSION (380)
BBQ CHICKEN (298)	*CHARTREUSE SILVER (33)	GREEN HORNET (281)	MIDGE (371)	RAINBOW (152)
BLACK GUM (182)	*CHARTREUSE/BLACK PEPPER (141)	GREEN THUNDER (188)	*MONKEY MILK (203)	RED THUNDER (147)
BLACK/HOT PINK (0364)	CHARTREUSE/RED GLITTER (149)	GREEN TOMATO (194)	MUD DAUBER (388)	RED/CHARTREUSE SILVER (1809)
BLACK NIGHT (297)	COPPERNOSE (391)	GUMDROP (177)	NATURAL CRICKET (196)	SHIMMER SHAD (280)
BLEEDING SHAD (143)	CRYSTAL (148)	HOLOGRAM GHOST (145)	NEON PRISM (379)	SMOKE SILVER (92)
BLOOD MINNOW (390)	DIAMOND MIST (377)	HALO (279)	OPENING NIGHT (222)	SWEET TEA W/ LEMON (346)
BLUEBACK SHAD (348)	DOUBLE SILVER RAINBOW (153)	HOT LIPS (179)	PATRIOT (183)	TADPOLE (350)
BLUE CHROME (376)	DREAMSICLE DELIGHT (296)	ICE OUT (326)	PEARL CHARTREUSE (63)	*THREADFIN SHAD (191)
*BLUEGRASS (181)	*ECLIPSE (327)	INDIGO SKY (382)	*PEARL WHITE (65)	TUXEDO SHIMMER (295)
*BLUE ICE (336)	*ELECTRIC CHICKEN (219)	KEY LIME PIE (206)	PENNY BACK (325)	*VEGAS (204)
BLUE PEARL (144)	EMERALD SHAD (154)	KIWI (146)	PINK LEMONADE (347)	WATERMELON WINE (305)

To Order: 1-800-305-9866



# BOBBY GARLAND CRAPPIE BAIT

**1.25" ITTY BIT SLAB SLAY'R** The lure is small but the action big in Bobby Garland Crappie Bait new 1.25" Itty Bit Slab Slay'R. 20-count bag. **\$3.29**

- |                               |                                   |
|-------------------------------|-----------------------------------|
| IBSS153 DOUBLE SILVER RAINBOW | IBSS349 BLACK CRICKET             |
| IBSS195 CAJUN CRICKET         | IBSS350 TADPOLE                   |
| IBSS219 ELECTRIC CHICKEN      | IBSS0303 BLACK/ CHARTREUSE SILVER |
| IBSS336 BLUE ICE              | IBSS0364 BLACK/ HOT PINK          |
| IBSS346 SWEET TEA W/ LEMON    | IBSS1809 RED/ CHARTREUSE SILVER   |
| IBSS347 PINK LEMONADE         | IBSS1905 BONE WHITE/ CHARTREUSE   |



SWEET TEA WITH LEMON (346)

**2" & 3" SLAB SLAY'R** The perfect combination of a solid body and a thin spear-tail for enticing crappie. 2" in 12-count bag. 3" in 10-count bag. **\$3.29**

- |                             |                          |
|-----------------------------|--------------------------|
| SS153 DOUBLE SILVER RAINBOW | SS312 FULL MOON          |
| SS168 BUMBLEBEE             | SS325 PENNY BACK         |
| SS177 GUMDROP               | SS327 ECLIPSE            |
| SS181 BLUEGRASS             | SS328 STORM WARNING      |
| SS195 CAJUN CRICKET         | SS336 BLUE ICE           |
| SS219 ELECTRIC CHICKEN      | SS346 SWEET TEA W/ LEMON |
| SS281 GREEN HORNET          | SS347 PINK LEMONADE      |
| SS287 HORSEFLY              | SS350 TADPOLE            |
| SS288 LOVE BUG              | SS369 LIVE MINNOW        |
| SS295 TUXEDO SHIMMER        | SS373 GOLDMEMBER         |
| SS298 BBQ CHICKEN           | SS374 KEYSTONE CANDY     |
| SS311 LIGHTS OUT            | SS378 GREEN BANANA       |

- |                                 |
|---------------------------------|
| SS381 UGLY DUCKLING             |
| SS386 RED HORSE MINNOW          |
| SS392 SOUR MILK                 |
| SS0303 BLACK/CHARTREUSE SILVER  |
| SS0364 BLACK/HOT PINK           |
| SS0809 ORANGE/CHARTREUSE SILVER |
| SS1465 POWDER BLUE/PEARL WHITE  |
| SS1809 RED/CHARTREUSE SILVER    |
| SS1865 RED/PEARL WHITE          |
| SS1716 BLUE/PEARL WHITE         |
| SS1905 BONE WHITE/CHARTREUSE    |
| SS1965 BONE WHITE/PEARL WHITE   |

- |                                 |
|---------------------------------|
| SS3305 CHARTREUSE SILVER/CHART  |
| SS6416 PINK/PEARL WHITE         |
| SS4863 JUNEBUG/PEARL CHARTREUSE |
| SS8763 PUMPKINSEED/PEARL CHART. |



ELECTRIC CHICKEN (219)

To specify size, place 2 or 3 with color number

**2.5" STROLL'R** Stroll it. Troll it. Cast it. Jig it. No other crappie bait has this much action from head to tail. 12-count bag. **\$3.29**

- |                              |                            |
|------------------------------|----------------------------|
| SR63 PEARL CHARTREUSE        | SR278 MIDNIGHT SUN (LAM)   |
| SR65 PEARL WHITE             | SR287 HORSEFLY             |
| SR121 METEOR SHOWER          | SR288 LOVE BUG             |
| SR142 BLUE THUNDER (LAM)     | SR295 TUXEDO SHIMMER (LAM) |
| SR144 BLUE PEARL (LAM)       | SR311 LIGHTS OUT (LAM)     |
| SR147 RED THUNDER (LAM)      | SR313 GLACIER              |
| SR151 PINK PEARL (LAM)       | SR327 ECLIPSE (LAM)        |
| SR153 DOUBLE SILVER RAINBOW  | SR328 STORM WARNING        |
| SR177 GUMDROP (LAM)          | SR331 BLUE MOON            |
| SR181 BLUEGRASS (LAM)        | SR336 BLUE ICE (LAM)       |
| SR195 CAJUN CRICKET (LAM)    | SR350 TADPOLE (LAM)        |
| SR203 MONKEY MILK            | SR369 LIVE MINNOW (LAM)    |
| SR204 VEGAS (LAM)            | SR373 GOLDMEMBER           |
| SR219 ELECTRIC CHICKEN (LAM) | SR374 KEYSTONE CANDY       |
| SR259 SHINY HINEY            | SR375 GRENADA GOLD         |
| SR260 BLUE LIPS              | SR376 BLUE CHROME          |

- |                                 |
|---------------------------------|
| SR378 GREEN BANANA (LAM)        |
| SR379 NEON PRISM (LAM)          |
| SR380 PURPLE PASSION (LAM)      |
| SR386 RED HORSE MINNOW          |
| SR388 MUD DAUBER                |
| SR0303 BLACK/CHARTREUSE SILVER  |
| SR0363 BLACK/PEARL CHARTREUSE   |
| SR0364 BLACK/HOT PINK           |
| SR0633 BUBBLE GUM/CHART SILVER  |
| SR0809 ORANGE/CHARTREUSE SILVER |
| SR1716 BLUE/PEARL WHITE         |
| SR1809 RED/CHARTREUSE SILVER    |
| SR1810 BLUEGILL/FIRE            |
| SR1905 BONE WHITE/CHARTREUSE    |
| SR4863 JUNEBUG/PEARL CHARTREUSE |
| SR8763 PUMPKINSEED/PEARL CHART  |



BLACK/HOT PINK (0364)

**2" SPLIT TAIL** Proof that two tails are better than one for finicky feeders. 15-count bag. **\$3.29**

- |                             |                               |
|-----------------------------|-------------------------------|
| ST49 CHARTREUSE GREEN       | ST157 PEARL SALT AND PEPPER   |
| ST63 PEARL CHARTREUSE       | ST180 CHARTREUSE GOLD GLITTER |
| ST92 SMOKE SILVER           | ST203 MONKEY MILK             |
| ST153 DOUBLE SILVER RAINBOW | ST313 GLACIER                 |
| ST155 PINK COTTON CANDY     | ST336 BLUE ICE                |
| ST156 PEARLESCENT           |                               |



BLUE ICE (336)

**2" SWIMMING MINNOW** The best swimming tail on the market in a crappie minnow bait. 15-count bag. **\$3.29**

- |                                   |                                      |
|-----------------------------------|--------------------------------------|
| 2SM32 FIRECRACKER                 | 2SM159 PURPLE MIST (LAM)             |
| 2SM33 CHARTREUSE SILVER           | 2SM161 PASSIONATE PURPLE             |
| 2SM63 PEARL CHARTREUSE            | 2SM162 SMOKE BLUE                    |
| 2SM65 PEARL WHITE                 | 2SM165 SMOKIN JOE BLEEDING BLUE SHAD |
| 2SM89 SMOKE                       | 2SM166 GRAPE SILVER                  |
| 2SM92 SMOKE SILVER                | 2SM181 BLUEGRASS (LAM)               |
| 2SM142 BLUE THUNDER (LAM)         | 2SM195 CAJUN CRICKET (LAM)           |
| 2SM148 CRYSTAL (LAM)              | 2SM203 MONKEY MILK                   |
| 2SM150 LICORICE CHART PEARL (LAM) | 2SM219 ELECTRIC CHICKEN (LAM)        |
| 2SM154 EMERALD SHAD (LAM)         | 2SM336 BLUE ICE (LAM)                |



BLUE ICE (336)

Unique swim foot on tip of tail affords fast-start swimming action and lively tail action at slow retrieves.

To Order: [www.grizzlyjig.com](http://www.grizzlyjig.com)

# BOBBY GARLAND CRAPPIE BAITS

STROLL'R - COLORS SR



SLAB SLAY'R - COLORS SS



JIGS, SOFT BAITS, AND CRANK BAITS



# BOBBY GARLAND CRAPPIE BAIT

**2.25" SLAB HUNT'R MINNOW** The Slab Hunt'R is a large profile minnow bait with unique easy-swim tail and a body design for holding optional scent and crappie rattle to serve up sight, sound and smell. 10-count bag.

- |                              |                               |
|------------------------------|-------------------------------|
| SH63 PEARL CHARTREUSE        | SH369 LIVE MINNOW (LAM)       |
| SH181 BLUEGRASS (LAM)        | SH375 GRENADA GOLD            |
| SH191 THREADFIN SHAD (LAM)   | SH384 GREEN LANTERN (LAM)     |
| SH195 CAJUN CRICKET (LAM)    | SH388 MUD DAUBER              |
| SH203 MONKEY MILK            | SH389 PURPLE MONKEY           |
| SH219 ELECTRIC CHICKEN (LAM) | SH390 BLOOD MINNOW            |
| SH287 HORSEFLY               | SH391 COPPERNOSE              |
| SH291 BRIGHT WHITE           | SH1810 BLUEGILL/FIRE          |
| SH311 LIGHTS OUT (LAM)       | SH1905 BONE WHITE/ CHARTREUSE |
| SH313 GLACIER                | SH4863 JUNEBUG/ CHARTREUSE    |
| SH336 BLUE ICE (LAM)         |                               |

**\$3.29**



CAJUN CRICKET (195)



**2.5" PILE DIVER** The Pile Diver is designed for tantalizing action in and around a crappie's favorite hideout – the brush pile. Ribbed body vibrates on contact with limbs. Streamer-like legs tickle a crappie's fancy. 10-count bag.

**\$3.49**

- |                              |                        |
|------------------------------|------------------------|
| DV65 PEARL WHITE             | DV219 ELECTRIC CHICKEN |
| DV128 MO' GLO BLUE GHOST     | DV311 LIGHTS OUT!      |
| DV149 CHARTREUSE RED GLITTER | DV313 GLACIER          |
| DV181 BLUEGRASS              | DV336 BLUE ICE         |
| DV187 MO' GLO OUTLAW SPECIAL | DV369 LIVE MINNOW      |
| DV191 THREADFIN SHAD         | DV372 MO' GLO SUNSET   |
| DV195 CAJUN CRICKET          | DV0364 BLACK/ HOT PINK |
| DV203 MONKEY MILK            |                        |

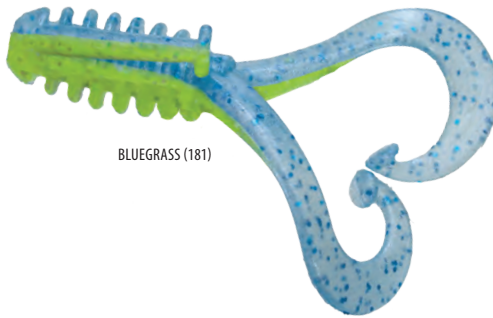

BLUEGRASS (181)



**1.5" CRAPPIE SHOOTER** Compact, streamlined and aerodynamic, the Crappie Shooter is the perfect shooting/skipping bait. 12 per bag.

**\$3.29**

- |                              |                             |
|------------------------------|-----------------------------|
| CS191 THREADFIN SHAD (LAM)   | CS313 GLACIER               |
| CS195 CAJUN CRICKET (LAM)    | CS336 BLUE ICE (LAM)        |
| CS203 MONKEY MILK            | CS350 TADPOLE (LAM)         |
| CS219 ELECTRIC CHICKEN (LAM) | CS369 LIVE MINNOW (LAM)     |
| CS311 LIGHTS OUT (LAM)       | CS0364 BLACK/HOT PINK (LAM) |



GLACIER



# BOBBY GARLAND CRAPPIE BAITS



## 2" MO' GLO SWIMMING MINNOWS 15-count bag.

**\$3.29**

- MG2SM129 PINK PHANTOM (LAM)
- MG2SM187 OUTLAW SPECIAL (LAM)
- MG2SM247 SUNRISE (LAM)
- MG2SM284 SCREAMER (LAM)



SCREAMER (284)

# Mo' Glo

## MO' GLO BABY SHAD Bright in daylight; glow in the dark. 18-count bag.

**\$3.29**

- MGBS43 GHOST
- MGBS127 GHASTLY MINNOW (LAM)
- MGBS128 BLUE GHOST (LAM)
- MGBS129 PINK PHANTOM (LAM)
- MGBS187 OUTLAW SPECIAL (LAM)
- MGBS247 SUNRISE (LAM)
- MGBS248 TWILIGHT (LAM)
- MGBS249 ELECTRIC CHICKEN GLO (LAM)
- MGBS284 SCREAMER (LAM)
- MGBS285 DEVIL'S GRIN (LAM)
- MGBS372 SUNSET (LAM)

- MGBS383 THE SHADOW (LAM)
- MGBS384 GREEN LANTERN (LAM)
- MGBS385 MONKEY MILK GLO



PINK PHANTOM (129)

See Baby Shad Mo' Glo Color Chart

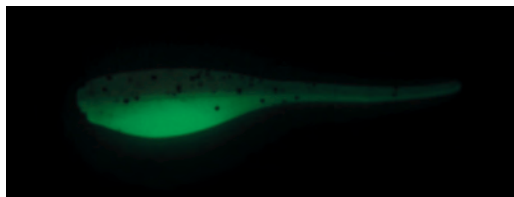

## MO' GLO STROLL'R Bright in daylight; glow in the dark. 12-count bag.

**\$3.29**

- MGSR43 GHOST
- MGSR127 GHASTLY MINNOW (LAM)
- MGSR128 BLUE GHOST (LAM)
- MGSR129 PINK PHANTOM (LAM)
- MGSR187 OUTLAW SPECIAL (LAM)
- MGSR247 SUNRISE (LAM)
- MGSR248 TWILIGHT (LAM)
- MGSR249 ELECTRIC CHICKEN GLO (LAM)
- MGSR284 SCREAMER (LAM)
- MGSR285 DEVIL'S GRIN (LAM)
- MGSR372 SUNSET (LAM)



GHOST (43)

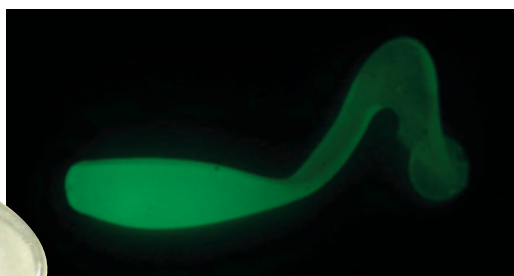

## MO' GLO SLAB SLAY'R Bright in daylight; glow in the dark.

**\$3.29**

- 2" SLAB SLAY'R 12-count bag
- MG2SS43 GHOST
  - MG2SS127 GHASTLY MINNOW
  - MG2SS384 GREEN LANTERN
  - MG2SS128 BLUE GHOST
  - MG2SS129 PINK PHANTOM
  - MG2SS187 OUTLAW SPECIAL
  - MG2SS247 SUNRISE
  - MG2SS248 TWILIGHT
  - MG2SS249 ELECTRIC CHICKEN GLO
  - MG2SS284 SCREAMER
  - MG2SS285 DEVIL'S GRIN
  - MG2SS372 SUNSET

- 3" SLAB SLAY'R 10-count bag
- MG3SS43 GHOST
  - MG3SS127 GHASTLY MINNOW
  - MG3SS384 GREEN LANTERN
  - MG3SS128 BLUE GHOST
  - MG3SS129 PINK PHANTOM
  - MG3SS187 OUTLAW SPECIAL
  - MG3SS247 SUNRISE
  - MG3SS248 TWILIGHT
  - MG3SS249 ELECTRIC CHICKEN GLO
  - MG3SS284 SCREAMER
  - MG3SS285 DEVIL'S GRIN
  - MG3SS372 SUNSET

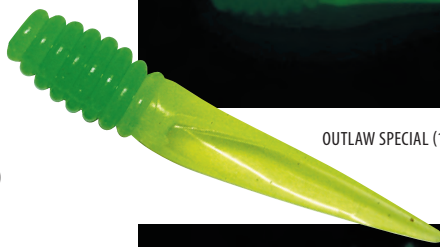

OUTLAW SPECIAL (187)

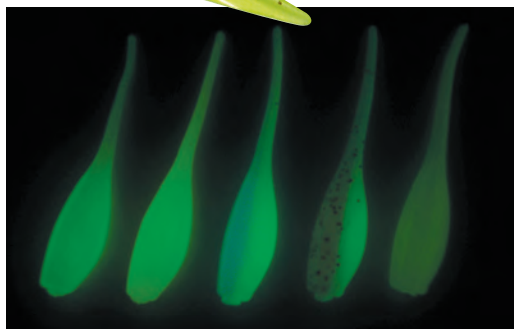
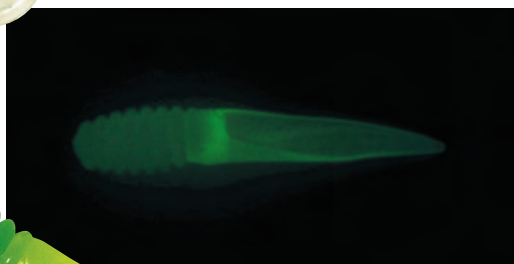

Bobby Garland Mo' Glo baits glow in different colors according to hues, providing contrasting shades in two-color lures.



MO' GLO BLUE GHOST (128)



MO' GLO OUTLAW SPECIAL (187)



MO' GLO SCREAMER (284)



MO' GLO PINK PHANTOM (129)



MO' GLO ELECTRIC CHICKEN (249)



MO' GLO DEVIL'S GRIN (285)



MO' GLO GHASTLY MINNOW (127)



MO' GLO SUNRISE (247)



MO' GLO GHOST (43)



MO' GLO SUNSET (372)



MO' GLO GREEN LANTERN (384)



MO' GLO TWILIGHT (248)

To Order: 1-800-305-9866



# BOBBY GARLAND CRAPPIE BAITS

**ACCESSORIES** Dress for success by adding scent, sound and flash to your crappie jigs with these innovative accessories. And dare to send your jig into spots where traditional techniques can't reach with Garland's Dock Shoot'R Pull Tabs.



### CRAPPIE DOCK SHOOT'R PULL TABS

These waterproof and tear-proof pull tabs simply slip over the point of a rigged jighead to provide an easier, safer and more reliable way to hold and release a bait for dock shooting than by the hook. Holographic version provides fish attracting flash. Natural Fin adds to the bait's natural look.

PULL356-24 HOLOGRAPHIC SCALE  
PULL65-24 NATURAL FIN

1/4" X 7/8" 24/PACK **\$4.99**



### ITTY BITS JIGHEADS

Little jigheads with a big bite. These tiny heads, featuring an optimal "down" bait keeper ideal for holding tiny bodies and fitted with a super sharp Eagle Claw® #8 hook, are a perfect complement to Itty Bit baits. Unpainted. 20-count pack.

148IBJ-20 1/48 OZ.; SIZE 8 HOOK  
164IBJ-20 1/64 OZ.; SIZE 8 HOOK

**\$3.99**



**MO' GLO SLAB JAM** Long lasting and easy-to-apply minnow-scent gel formulated especially for crappie. 1.25 oz. **\$3.29**

MGSJ-1 MO' GLO SLAB JAM



**CRAPPIE GLASS RATTLES** 3-ball tiny glass rattles made exclusively for Bobby Garland to fit small soft-plastic crappie baits. 15 count.

3M916RT3-15 USA GLASS CRAPPIE RATTLES (3MM - 9/16")

**\$4.79**



## CRAPPIE PRO JIGHEADS *Crappie* Pro

### OVERBITE SICKLE MO' GLO JIGHEADS

Overbites solve the age-old dilemma of little jig heads also meaning little hooks. Sickle hooks unique shape fits tiny and regular size crappie baits. 10-count bag.

1/16 OZ.: SIZE 2 SICKLE HOOK	1/32 OZ.: SIZE 6 SICKLE HOOK	1/48 OZ.: SIZE 6 SICKLE HOOK
116OBS06 MO' GLO PINK	132OBS06 MO' GLO PINK	148OBS06 MO' GLO PINK
116OBS17 MO' GLO BLUE	132OBS17 MO' GLO BLUE	148OBS17 MO' GLO BLUE
116OBS43 MO' GLO GHOST	132OBS43 MO' GLO GHOST	148OBS43 MO' GLO GHOST
116OBS62 MO' GLO ORANGE	132OBS62 MO' GLO ORANGE	148OBS62 MO' GLO ORANGE
116OBS63 MO' GLO CHARTREUSE	132OBS63 MO' GLO CHARTREUSE	148OBS63 MO' GLO CHARTREUSE

**\$4.79**

1/48 OZ. PINK



### MO' GLO GLOW-IN-THE-DARK JIGHEADS 1/24 oz., 1/16 oz., 1/8 oz. and 3/16 oz. 10-count bag.

1/24 oz.: Size 4 black chrome hook	1/8 oz.: Size 1 black chrome hook
124MGH06-10 PINK GLO	18MGH06-10 PINK GLO
124MGH17-10 BLUE GLO	18MGH17-10 BLUE GLO
124MGH43-10 GHOST GLO	18MGH43-10 GHOST GLO
124MGH62-10 ORANGE GLO	18MGH62-10 ORANGE GLO
124MGH63-10 CHARTREUSE GLO	18MGH63-10 CHARTREUSE GLO
1/16 oz.: Size 2 black chrome hook	3/16 oz.: Size 1 black chrome hook
116MGH06-10 PINK GLO	316MGH06-10 PINK GLO
116MGH17-10 BLUE GLO	316MGH17-10 BLUE GLO
116MGH43-10 GHOST GLO	316MGH43-10 GHOST GLO
116MGH62-10 ORANGE GLO	316MGH62-10 ORANGE GLO
116MGH63-10 CHARTREUSE GLO	316MGH63-10 CHARTREUSE GLO

**\$4.79**



To Order: [www.grizzlyjig.com](http://www.grizzlyjig.com)



# BOBBY GARLAND CRAPPIE BAITS



JIGS, SOFT BAITS, AND CRANK BAITS

## 2.5" SLAB DOCKT'R

Although bulked up and shaped especially for skipping under docks, this large profile bait with twin kicker tails brings a new level of performance to all crappie techniques. 12 per bag.

- |                                       |                              |
|---------------------------------------|------------------------------|
| DR33 CHARTREUSE SILVER                | DR203 MONKEY MILK            |
| DR65 PEARL WHITE                      | DR204 VEGAS (LAM)            |
| DR142 BLUE THUNDER (LAM)              | DR219 ELECTRIC CHICKEN (LAM) |
| DR150 LICORICE/CHARTREUSE PEARL (LAM) | DR311 LIGHTS OUT (LAM)       |
| DR181 BLUEGRASS (LAM)                 | DR313 GLACIER                |
| DR187 OUTLAW SPECIAL (LAM)            | DR336 BLUE ICE (LAM)         |
| DR191 THREADFIN SHAD (LAM)            |                              |

**\$3.49**



THREADFIN SHAD (191)

For SLAB DOCKT'R colors, see the alphabetical-listed Baby Shad color chart for identification of the Slab Dockt'R color names listed here.

## 2.25" MINNOW MIND'R

Tip it with a live minnow or fish it as is. This unique twin-tailed crappie catcher provides color, flash and hook-holding security to a live minnow. 12-count bag.

**\$3.29**

- |                     |                    |                              |
|---------------------|--------------------|------------------------------|
| MM203 MONKEY MILK   | MM245 STINK BUG    | MM311 LIGHTS OUT             |
| MM237 FIREFLY       | MM246 DRAGONFLY    | MM312 FULL MOON              |
| MM238 BEETLEJUICE   | MM281 GREEN HORNET | MM313 GLACIER                |
| MM239 ROLY POLY     | MM282 BLUE DAUBER  | MM326 ICE OUT (LAM)          |
| MM240 BLACK WIDOW   | MM287 HORSEFLY     | MM329 GLITTER CRITTER        |
| MM241 YELLOW JACKET | MM288 LOVE BUG     | MM330 LIGHTNING BUG          |
| MM242 BED BUG       | MM289 DEER FLY     | MM388 MUD DAUBER             |
| MM243 SILVERFISH    | MM299 CICADA       | MM1905 BONE WHITE/CHARTREUSE |
| MM244 LADY BUG      | MM300 MAY BUG      |                              |



ROLY POLY (239)



## 2.5" SCENT WIGGL'R

Scent is cooked in to this dancing minnow imitation.

Use it on a jig as is, or separate the segments and use any piece to add color and scent to any crappie jig. Works great with the Minnow Mind'R. 18-count bag.

**\$3.29**

- |                                      |  |
|--------------------------------------|--|
| MGSW43 MO' GLO GHOST                 | MGSW249 MO' GLO ELECTRIC CHICKEN (LAM) |
| MGSW127 MO' GLO GHASTLY MINNOW (LAM) | SW250 FLUORESCENT ORANGE SPARKLE       |
| MGSW128 MO' GLO BLUE GHOST (LAM)     | SW251 FLUORESCENT CHART PEARL SPARKLE  |
| MGSW129 MO' GLO PINK PHANTOM (LAM)   | SW252 FLUORESCENT WHITE SPARKLE        |
| SW181 BLUEGRASS (LAM)                | SW253 FLUORESCENT PINK SPARKLE         |
| MGSW187 MO' GLO OUTLAW SPECIAL (LAM) | SW297 BLACK NIGHT (LAM)                |
| SW191 THREADFIN SHAD (LAM)           | SW298 BBQ CHICKEN (LAM)                |
| MGSW247 MO' GLO SUNRISE (LAM)        | SW336 BLUE ICE (LAM)                   |
| MGSW248 MO' GLO TWILIGHT (LAM)       |  |



MO' GLO TWILIGHT (248)



To Order: 1-800-305-9866



Big T Fringe Fry 2" - 12 Pk  
 #MJ2 \_\_ \_\_ color **\$3.29**



Mermaid Jig 2.5" - 15 Pk  
 #MJ2 \_\_ \_\_ color **\$3.29**



Big T Fry Baby 2" - 15 Pk  
 #BTFB2 \_\_ \_\_ color **\$3.29**

Big T Fry Daddy 3" - 12 Pk  
 #BTFB3 \_\_ \_\_ color **\$3.29**



Big T Paddle Fry 2" - 15 Pk  
 #BTPF2 \_\_ \_\_ color **\$3.29**

To Order: [www.grizzlyjig.com](http://www.grizzlyjig.com)



Big T Curly Fry 2.25"  
- 12 Pk  
#BTCF2\_\_  
color **\$3.29**



JB-June Bug



MM-Mississippi Money



BG-Blue Grass



CAC-Candy Apple Chart



FI-Fire and Ice



LL-Lucky Leprechauns



PD-Pepper Dew



SD-Spud



BIC-Blue Ice Chart



CL-Chart Lime



FC-Funky Chicken



MC-Midnight Chart



PG-Pink Ghost



SB-Sun Burst



BM-Blue Moon



DM-Dirty Milk



GT-Glitter Time



MP-Midnight Pink



PP-Purple Passion



WM-Whatcha Macallit

### Slasher Crappie Jig Head

5 per pack in the 1/32, 1/16 and 1/8.  
4 per pack in the 1/4 ounce.

**\$4.99**



**1/4 oz.**  
SCJH014B Black  
SCJH014C Chartreuse  
SCJH014O Orange  
SCJH014P Pink  
SCJH014R Red  
SCJH014W White

**1/16 oz.**  
SCJH116B Black  
SCJH116C Chartreuse  
SCJH116O Orange  
SCJH116P Pink  
SCJH116R Red  
SCJH116W White

**1/8 oz.**  
SCJH018B Black  
SCJH018C Chartreuse  
SCJH018O Orange  
SCJH018P Pink  
SCJH018R Red  
SCJH018W White

**1/32 oz.**  
SCJH132B Black  
SCJH132C Chartreuse  
SCJH132O Orange  
SCJH132P Pink  
SCJH132R Red  
SCJH132W White

### Slasher Spin Jig Heads

**\$5.59 - 3 PK**



**1/4 oz.**  
SSJH014B Black  
SSJH014C Chartreuse  
SSJH014O Orange  
SSJH014P Pink  
SSJH014R Red  
SSJH014W White

**1/8 oz.**  
SSJH018B Black  
SSJH018C Chartreuse  
SSJH018O Orange  
SSJH018P Pink  
SSJH018R Red  
SSJH018W White

**1/16 oz.**  
SSJH116B Black  
SSJH116C Chartreuse  
SSJH116O Orange  
SSJH116P Pink  
SSJH116R Red  
SSJH116W White

**1/32 oz.**  
SSJH132B Black  
SSJH132C Chartreuse  
SSJH132O Orange  
SSJH132P Pink  
SSJH132R Red  
SSJH132W White

To Order: 1-800-305-9866

## Diamond Flash Holographic Colors



2" Tubby Grubs  
Diamond Flash Series

20 CT  
\$2.99



TG-0204  
JUNEBUG/CHART TAIL



TG-0230  
GLO



TG-0227  
OPAL AND PINK



TG-0117  
OPAL



TG-0152  
WATERMELON/CHART TAIL



TG-0136  
CLEAR/CHART.

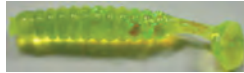

TG-0121  
CHARTREUSE



TG-0125  
SMOKE



TG-0109  
CRYSTAL CLEAR



TG-0184  
OPAL AND RED TAIL



TG-0132  
CHART AND RED TAIL



TG-0228  
SMOKE/CHART

2" Curly Tail  
Grub Diamond  
Flash Series

20 CT  
\$2.99



GR-0117  
OPAL



GR-0121  
CHARTREUSE



GR-0123  
PINK



GR-0228  
SMOKE/CHART



GR-0187  
CLEAR/WHITE



GR-0183  
CHART/ORANGE



GR-0136  
CLEAR/CHART



GR-0184  
OPAL/RED



GR-0109  
CRYSTAL CLEAR



GR-0227  
OPAL/PINK



GR-0204  
JUNEBUG/CHART



GR-0245  
PEPPER



GR-0151  
WATERMELON RED FLK



GR-0125  
SMOKE



GR-0186  
CLEAR/PINK



TT-0187  
CLEAR/WHITE TAIL



TT-0132  
CHART/RED TAIL



TT-0188  
SMOKE/WHITE



TT-0186  
CLEAR/PINK TAIL



TT-0190  
BLUE ICE/PINK TAIL



TT-0183  
CHART/ORANGE

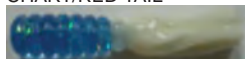

TT-0191  
BLUE ICE/WHITE TAIL

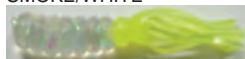

TT-0136  
CLEAR/CHART TAIL



TT-0204  
JUNEBUG/CHART



TT-0189  
SMOKE/PINK TAIL



TT-0121  
CHARTREUSE

15 CT  
\$2.99

2" Tasty Tube (Solid Body)  
Diamond Flash Series

\$5.99

Jig-N-Coat Powder Paint

JNC-BLUE  
JNC-WHITE  
JNC-YELLOW  
JNC-BLACK  
JNC-GLO  
JNC-HOT PINK

JNC-CHART/GLITTER  
JNC-BLAZE ORANGE  
JNC-BLOOD RED  
JNC-FLO GREEN  
JNC-BROWN  
JNC-PURPLE GLITTER  
JNC-SILVER HOLO GLITTER  
JNC-GOLD GLITTER

JNC-YELLOW CHARTREUSE  
JNC-BLACK GLITTER



\$4.99

Dip-N-Glo Plastic Worm Dye  
with Gamefish Scent

DNG-CHARTREUSE  
DNG-BLACK  
DNG-HOT PINK  
DNG-ORANGE  
DNG-FIRE RED



## Ready Made Crappie Rigs

Crappie Rigs  
Reelfoot & Kentucky Lake Style  
Light Wire Gold E.C.Hooks

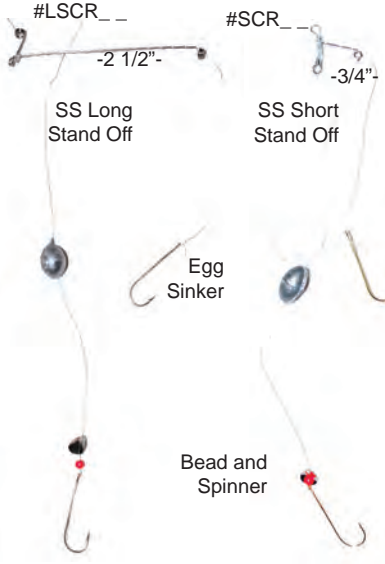

**3 PK  
\$3.49**

**Box of 36**  
1/4, 3/8, and 1/2 oz.  
**\$31.95**  
3/4 and 1 oz. **\$34.95**

### GRIZCO CRAPPIE RIG WIRES

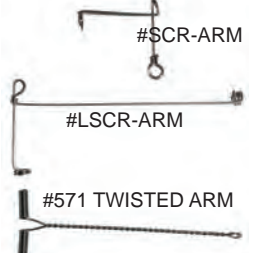

Pk....	10	\$ .99
Pk....	100	\$ 8.99
Pk....	1000	\$86.99

Make Your Own Rigs  
Nickle Rig Spinners 100 pk **\$4.95**  
Flo Red Beads 100 pk **\$1.95**  
Rig Tubes 6" Cut 50 pk **\$5.00**

Grizzly Jig Rig  
Color makes the difference.

**2 PK  
\$2.99**



#GJC-GR-\_\_

**10 Colors**

- 01 Black
- 02 White
- 03 Kelly Green
- 04 Orange
- 05 Yellow
- 06 Chartreuse
- 07 Pink
- 08 Purple
- 09 Grizzly Gray
- 10 Red

### LINDY RIGGER Holds 12 Rigs

LINDY RIGGER  
Holds 12 Rigs  
Item Count Price



Item	Count	Price
AC-100	1 ea.	\$4.99
AC-101	Bx/6	\$26.99
AC-103	3 ea. w/	\$14.95

Plastic T-Box

Blue Plastic Rig Holders  
Reusable!!



Item	Quantity	Price
LW6-BLUE-10H	10 PK	\$3.50
LW6-BLUE-50H	50 PK	\$16.95
LW6-BLUE-100H	100 PK	\$29.95

## GRIZCO



Kentucky Lake  
Trolling Jigs

- Pony Head w/ Barb
- Colorado Blades

#KLT-UP Unpainted  
#KLT-B Black  
#KLT-W White  
#KLT-O Orange  
#KLT-C Chartreuse  
Add Size and Amount

#### UNPAINTED

#### PAINTED

SIZE	5 PK	25 PK	SIZE	5 PK	25 PK
1/16 oz.	\$3.49	\$15.95	1/16 oz.	\$3.69	\$17.95
1/8 oz.	\$3.49	\$15.95	1/8 oz.	\$3.69	\$17.95
1/4 oz.	\$3.69	\$15.95	1/4 oz.	\$3.89	\$17.95

## Tip-Its

Tip-Its for the above rigs.

**2 PK  
99¢**



**Build  
Your Own  
Jig Rigs  
or  
Use It As  
A Single  
Hook**

Tip with small *shiner* or *rosie red*.  
OR  
It can be used as a trailer on a long line behind a road runner.

**To Order: 1-800-305-9866**



New for 2020!











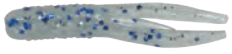

**1 3/4" Stump Bugs**

**\$2.99**

**Item #SB\_\_**

COLOR

Durable soft plastic • High-action split tail • Made in the USA • 16 Pk.

				
BN - Black Neon	BS - Bleeding Shiner	BG - Blue Grass	BI - Blue Ice	CF - Confetti
				
CC - Confetti Chart	CK - Crazy Chicken	GV - Grapevine	GS - Green Shad	LL - Lemon Lime
				
NS - Night Stick	PA - Palestine Special	PD - Paradise	PS - Purple Shad	SS - Silver Shad
				
SK - Slick	SN - Slick Neon	WL - White Lightning	MD - Moon Dust	BM - Blood Moon

**2" Brush Glider**

**\$2.99**

**Item #BG\_\_**

COLOR

Wide body profile • Ridged body design • Versatile beaver tail • Durable soft plastic, Made in the USA, 16 Pk.

				
BN - Black Neon	BS - Bleeding Shiner	BG - Blue Grass	BI - Blue Ice	CF - Confetti
				
CC - Confetti Chart	CK - Crazy Chicken	GV - Grapevine	GS - Green Shad	LL - Lemon Lime
				
NS - Night Stick	PA - Palestine Special	PD - Paradise	PS - Purple Shad	SS - Silver Shad
				
SK - Slick	SN - Slick Neon	WL - White Lightning	MD - Moon Dust	BM - Blood Moon





**2.5" Minnow**

**\$2.99**

**Item #MN\_\_**

COLOR

Made in the USA • 16 Pk.

				
CF - Confetti	CC - Confetti Chart	SK - Slick	MD - Moon Dust	BI - Blue Ice
				
BG - Blue Grass	GS - Green Shad	BS - Bleeding Shiner	PD - Paradise	PS - Purple Shad
				
CK - Crazy Chicken	CP - Pearl Chart			

### Slim Stick

Long pointed tail • Durable soft plastic • Baitfish style profile, • Made in the USA • 16 Pk.

**\$2.99**      **2 3/8"** Item #S2\_\_\_\_  
COLOR      **3"** Item #S3\_\_\_\_  
COLOR



### BX Jig Heads

**\$4.99**

Made in USA • 10 pk: 1/8 or 1/16 • 5 pk: 1/4

**1/8 oz. #BX18**\_\_\_\_ **1/16 oz. #BX116**\_\_\_\_ **1/4 oz. #BX14**\_\_\_\_  
COLOR      COLOR      COLOR



### BX Bladed Jig Heads

**\$4.99**

Made in USA • 5 pk

**1/8 oz. #BXB18**\_\_\_\_ **1/16 oz. #BXB116**\_\_\_\_  
COLOR      COLOR



### Bulk Jig Heads (With Collar)

**\$4.99 • 20 Pk**

**1/8 oz. #BX18B20**

**1/16 oz. #BX116B20**



### Bulk Jig Heads (No Collar)

**\$4.99 • 20 Pk**

**1/8 oz. #BX18NCB20**

**1/16 oz. #BX116NCB20**



To Order: 1-800-305-9866

**NEW!**



**PRO TIP-ITS**

- Tip with a shiner or rosie red
- Build your own jig rigs
- #1 red Eagle Claw sickle style hooks

**\$1.49  
2 PK**

#GJC-ATPI-\_\_

#1 Baby Bass	#6 Black/Chart	#11 Pink/Chart	#16 Purple/Purple/Chart	#21 Pink/Pink
#2 White/Black	#7 White/Chart	#12 White/Glo Pearl	#17 White/Blue/Pearl/Red	#22 Pink/Glo-Pink
#3 Red/Chart	#8 White/Blue	#13 White/Pearl	#18 Orange/Chart	#23 Green/Pearl
#4 Orange/Orange Glo	#9 Orange/Black	#14 Orange/Orange	#19 Blue/Glo Blue	#24 Blue Chart
#5 Chart/Purple	#10 Chart/Chart Glo	#15 Chart/Chart	#20 Purple/Purple	

**Ross Whitney's  
CRAPPIE PRO BEAD JIGS**

1/26 oz.

Size 1 214 EL Eagle Claw Hook



2001 Crappie USA Champion

**\$3.99  
3 PK**

RW-G2 Pink/Chart/Pink	RW-G12 Chart/Black
RW-G4 White/Blk&White/Blue Slvr	RW-G13 Red/Chart
RW-G8 Black/Yellow&Blk/Chart	RW-G10 Green/Purple/Chart
RW-G11 Green/Orange&Blk Chart	RW-G14 Pink/Black

To Order: [www.grizzlyjig.com](http://www.grizzlyjig.com)





# BUY BULK & SAVE

**EAGLE CLAW®**

GOLD ABERDEEN JIG HOOK



SIZE	100 PK	1000 PK
#6, 8, 10	9.99	39.95
#4, 2, 1	9.99	39.99
1/0	10.99	42.99
2/0	11.99	46.99
3/0, 4/0	11.99	59.99

BRONZE ABERDEEN JIG HOOK



SIZE	100 PK	1000 PK
#6, 8, 10	7.49	29.99
#4, 2, 1	7.99	29.99
1/0	8.15	34.95
2/0	8.99	36.95
3/0	9.99	42.95
4/0	9.99	44.95

GOLD ABERDEEN CRAPPIE HOOK



(EXTRA LITE)

\*Standard Gold Hook

SIZE	10 PK	50 PK	100 PK	1000 PK
#6, 8, *10	1.69	5.59	8.99	59.99
#4, 2, 1	1.69	5.59	8.99	59.99
1/0	1.79	5.99	9.49	62.99
2/0	1.79	6.49	9.59	66.95
*3/0	1.99	6.99	9.99	69.95
*4/0	N/A	N/A	10.99	N/A

BRONZE BAITHOLDER



SIZE	10 PK	100 PK
#6, 8	1.99	12.79
#4, 2	1.99	12.79
1	1.99	12.79
8 PK		100 PK
1/0	1.99	12.99
2/0	1.99	15.29
3/0	2.19	16.99
4/0	2.25	19.99
5/0	2.49	21.99

GOLD HAT HOOK OR TIE CLASP

**EAGLE CLAW®**

155M



60¢  
ea

To Order: 1-800-305-9866



**EAGLE CLAW®**

BRONZE CATFISH HOOK  
PLAIN SHANK - OFFSET

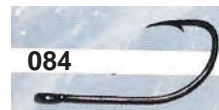

SIZE	10 PK	100 PK
#2, 4	1.69	7.49
1	1.69	7.49
8 PK		100 PK
1/0	1.79	8.49
2/0	1.79	9.99
3/0	1.79	11.49
4/0	1.79	11.99
5/0	1.99	12.99
6/0	2.09	14.99
7/0	2.29	16.99
8/0	2.39	19.99
9/0	2.69	23.99
10/0	2.99	28.99

084RA RED HOOK

SIZE	8PK	100 PK
1/0	2.59	N/A
3/0	2.59	N/A
5/0	2.59	N/A
7/0	2.59	N/A



**PRO-V SICKLE STYLE**

**EAGLE CLAW®**

90° Jig Hook  
Red Chrome

CODE	SIZE	100 PK PRICE	1000 BULK PRICE
500-10	10	\$5.99	\$45.95
500-8	8	\$5.99	\$45.95
500-6	6	\$5.99	\$45.95
500-4	4	\$6.99	\$47.95
500-2	2	\$6.99	\$47.95
500-1	1	\$6.99	\$47.95
500-1/0	1/0	\$7.99	\$51.95
500-2/0	2/0	\$8.99	\$60.95
500-3/0	3/0	\$9.99	\$67.95
500-4/0	4/0	\$11.95	\$76.95



(Lil Nasty)



**EAGLE CLAW®**

254SS STAINLESS  
O'SHAUGHNESSY



254SS

SIZE	100 PK
1/0	15.95
2/0	19.95
3/0	23.99
4/0	28.99
5/0	31.99
6/0	38.99
7/0	43.99
8/0	56.99
9/0	68.99
10/0	46.95 50 PK

049SSM STAINLESS  
Big Eye TROTLINE LIMERCK



049SSM

SIZE	BOX-1000 BULK
1/0	69.95
2/0	89.95
3/0	99.95

MUSTAD  
HM7904BR LIVER HOOK



SIZE	2 PK	10 PK
6	3.99	19.99
4	3.99	19.99
2	3.99	19.99

**ULTRA POINT**  
Mustad

DEMON CIRCLE HOOK  
#H-M39951NP-BN



SIZE	4 PK
9/0	4.99
10/0	4.99

TREBLE DOUGHBAIT HOOKS



SIZE	12 PK	1/4 GROSS (36)
DTH-6	1.95	6.50
DTH-4	1.95	6.50

BRONZE IMPORT TREBLE HOOKS

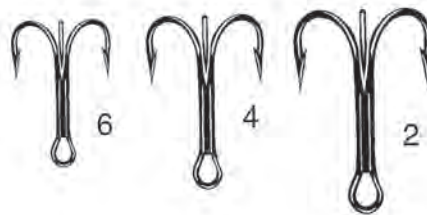
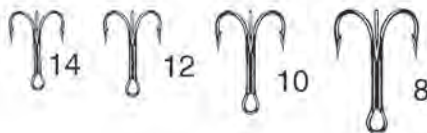

SIZE	PRICE	
	1/4 GROSS (36)	1 GROSS (144)
#14, 12	4.99	13.99
#10, 8	4.99	14.99
6, 4	5.50	15.99
2	5.99	16.99
1	5.99	17.99
1/0	6.99	23.95
2/0	7.50	26.95
3/0	8.49	28.95
4/0	8.99	30.95
5/0	9.99	33.99
6/0	11.99	44.99
7/0	12.99	49.99
8/0	14.99	56.99
10/0	22.99	82.99
12/0	34.99	129.99
14/0	39.99	149.99

**Weighted Snagging Hooks**



Bronze treble hooks with lead available in bulk or individually packed.

6/0 10/0  
1-1/4 oz. 2-1/2 oz.

SIZE	EA	DOZEN
SH-4/0	.99	9.99
SH-6/0	1.19	11.99
SH-8/0	1.49	14.95
SH-10/0	1.69	16.95
SH-12/0	1.89	18.95



**EAGLE CLAW®**

SNELLED HOOKS  
#139 BAIT HOLDER



SIZE	PK	PRICE
#2, 1	6	1.89
1/0, 2/0, 3/0	6	1.89

SNELLED HOOKS  
#121 BAIT HOLDER



SIZE	PK	PRICE
#4, 2, 1	6	1.89
1/0, 2/0, 3/0	6	1.89

**GRIZCO**

JIG SPINNERS  
WITH STAINLESS  
BLADES

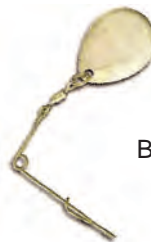

BJS-

SIZE	PRICE
00	1.99
0	1.99
1	1.99
2	1.99



L214 RED CRAPPIE HOOK



**EAGLE CLAW®**

RED CRAPPIE HOOK

SIZE	PRICE	
	#L214RGH_ 10 PK	#L214RFH_ 50 PK
8	2.19	5.99
6	2.19	5.99
4	2.19	5.99
2	2.19	5.99
1	2.19	5.99
	<b>8 PK</b>	<b>50 PK</b>
1/0	2.19	5.99

# CATFISH HOOKS



## #208 OCTOPUS CIRCLE HOOK

NS Black  
Offset



ITEM	SIZE	6 PK	25 PK
208411	1/0	3.59	12.99
208412	2/0	3.59	12.99
208413	3/0	3.59	12.99
208414	4/0	3.59	12.99
208415	5/0	3.59	12.99
208416	6/0	3.59	12.99
208417	7/0	3.59	13.99
208418	8/0	3.59	13.99

## #023 RED OCTOPUS HOOK

Red  
Offset



ITEM	SIZE	25 PK
02315	5/0	12.99
02316	6/0	12.99
02317	7/0	13.99



## BIG CAT CIRCLE #3564

ITEM	SIZE	PK	PRICE
356416	6/0	6	4.99
356417	7/0	5	4.99
356418	8/0	5	4.99
356420	10/0	3	5.99
356422	12/0	3	5.99



## OCTOPUS NICKEL #020

ITEM	SIZE	PK	PRICE
02019	9/0	5	3.69
02020	10/0	5	3.69



## BIG RIVER BAIT HOOK 3 PK

ITEM	SIZE	PRICE
225420	10/0	8.99
225422	12/0	8.99

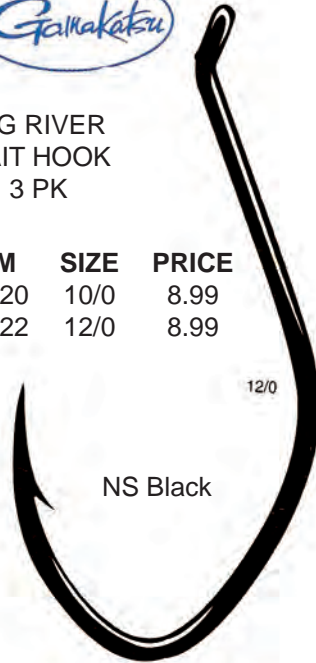

## TROTLINE HOOKS DURATIN #31010D

SIZE	100 PK
1/0	7.99
2/0	8.99
3/0	9.99
4/0	12.79
5/0	13.99
6/0	16.99
7/0	19.99



**EAGLE CLAW**

## BIG EYE TROTLINE HOOK



## LIMERICK - NON-OFFSET - ZINC

SIZE 100 PK

2/0	7.99
3/0	9.99
4/0	10.99
5/0	11.99



- Platinum Black
  - Octopus Circle
  - Wide Gap
  - Non-Offset
- Your Choice \$9.99**

L7228BPUH

SIZE	COUNT
5/0	29
6/0	23
7/0	19
8/0	17



## Platinum Black KING KAHLE HOOK #L141BPF

SIZE	PK	PRICE
5/0	50	8.99
7/0	50	9.99
8/0	50	17.99
9/0	50	18.99
10/0	50	19.99

## #L144SS STAINLESS KAHLE

SIZE	PK	PRICE
3/0	6	3.99
4/0	6	3.99
5/0	6	3.99
6/0	6	3.99

To Order: 1-800-305-9866



**Red Jig Hooks**



570R

SIZE	100 PK	1,000 PK
#8, 6, 4	\$ 9.99	\$42.95
#2	\$ 9.99	\$47.95
#1	\$10.99	\$55.95
#1/0	\$10.99	\$69.95
#2/0	\$10.99	\$69.95
#3/0	\$12.99	\$86.95

**Bronze Pro-V Jig Hook**  
(Compare to Matzuo Sickle)



500

SIZE	100 PK	1,000 PK
#8, 6, 4	\$5.99	\$29.99
#2, 1	\$6.49	\$31.99
#1/0	\$6.99	\$32.99
#2/0	\$6.99	\$35.99
#3/0	\$7.49	\$39.99

**Platinum Black Pro-V**



500BP

SIZE	100 PK	1,000 PK
#6, 4	\$7.99	\$38.95
#2, 1	\$8.99	\$39.95
#1/0	\$9.49	\$41.95
#2/0	\$10.99	\$49.95
#3/0	\$11.99	\$56.95

**Big Nasty Gold**  
Aberdeen



PRO-V 203GOLD

SIZE	10 PK	50 PK
1/0	\$1.79	\$6.99
1	\$1.69	\$6.49
2	\$1.69	\$6.49
4	\$1.69	\$6.49
6	\$1.69	\$6.49



**Circle Sea**

For Live and Cut Bait

Offset Platinum Black



L197B

SIZE	COUNT	PRICE
2/0	100 PK	\$17.95
3/0	100 PK	\$19.95
4/0	100 PK	\$20.95
5/0	100 PK	\$22.95
6/0	100 PK	\$24.95
7/0	100 PK	\$26.95

**Trot Line Big Eye Circle Hook**

Big Eye In Line



L198FH

SIZE	COUNT	PRICE
2/0	50 PK	\$ 9.49
3/0	50 PK	\$10.99
4/0	50 PK	\$11.99
5/0	50 PK	\$12.59



**TRIDENT HOOK**

2X Long Shank In-Line Circle

OHC BLACK



\$2.89

ITEM	SIZE	COUNT
OHC-705-19	7/0	5
OHC-805-2	8/0	5
OHC-904-21	9/0	4
OHC-1004-22	10/0	4

**2X Long Up Eye Circle**

OHC BLACK OFFSET



\$2.89

ITEM	SIZE	COUNT
OHC-506R-17	5/0	6
OHC-606R-18	6/0	6
OHC-705R-19	7/0	5
OHC-805R-2	8/0	5
OHC-904R-21	9/0	4
OHC-1004R-22	10/0	4



Jason Aycock - Grizzly Jig Pro Staff

To Order: [www.grizzlyjig.com](http://www.grizzlyjig.com)

## BRASS SNAP SWIVELS



MICRO

	DZ	GROSS (144)
BSS-20	1.29	9.99
BSS-14	1.29	9.99
BSS-12	1.29	9.99
BSS-10	1.29	9.99
BSS-7	1.49	11.99
BSS-5	1.69	12.99
BSS-3	1.89	17.99
BSS-1	2.39	22.99
BSS-1/0	2.59	24.99
BSS-2/0	2.95	29.49
BSS-3/0	3.79	35.95

## BLACK CROSSLINE SWIVEL

SIZE	DZ	GROSS
BCRS-10	1.79	10.95
BCRS-7-8	1.89	12.95
BCRS-5	1.99	13.95
BCRS-3	2.09	15.49
BCRS-1	2.19	18.95
BCRS-1/0	2.79	24.95
BCRS-2/0	2.99	26.95



## BRASS BARREL SWIVELS



SIZE	DZ	GROSS (144)
BBS-14	1.29	7.99
BBS-12	1.29	7.99
BBS-10	1.29	7.99
BBS-7	1.29	9.99
BBS-5	1.39	9.99
BBS-3	1.49	12.99
BBS-1	1.59	16.99
BBS-1/0	1.99	18.99
BBS-2/0	2.69	21.99
BBS-3/0	2.99	24.99
BBS-5/0	3.29	31.99

## BRASS 3-WAY SWIVELS



SIZE	DZ	GROSS (144)
TWS-8	1.89	12.99
TWS-5	1.89	16.99
TWS-4	1.89	17.99
TWS-3	1.99	18.99
TWS-1	2.49	24.95
TWS-1/0	2.79	27.95
TWS-3/0	3.99	N/A

## EAGLE CLAW® Black Interlock Snap Swivels



Item	Size	Qty
SBIBK-12	12	7
SBIBK-10	10	7
SBIBK-7	7	6
SBIBK-5	5	5
SBIBK-3	3	4
SBIBK-1	1	3
SBIBK-1/0	1/0	3
SBIBK-2/0	2/0	2
SBIBK-3/0	3/0	2

**\$1.39**  
per pk

**\$10.99**  
box of 12 pks

# SINKERS ~ BAG or BULK

The price of lead has gone crazy! We will hold these prices as long as we can. Price may increase without notice!

### Egg Sinkers



**BULK**

Item # **EGS-**\_\_\_\_  
Size

Size 5#  
1/4, 3/8, 1/2, 3/4, 1 **\$15.99**

Size 5#  
1 1/2, 2, 3, 4, 6, and 8 oz. **\$13.99**

### Removable Split-Shot Sinkers

Item # **RSS-**\_\_\_\_  
Size



Size BB  
3/0 **\$1.29**  
7 **per bag**  
5 **\$10.99**  
4 **per box**  
3 **of 12 bags**  
2

### Bulk Bank Sinkers

Item # **BANK-**\_\_\_\_  
Size



Oz.  
1/2, 3/4, 1, 1 1/2, 2,  
2 1/2, 3, 4, 5, 6,  
8, 10, or 12

5# **\$13.99**

### Pinch-On Sinkers



Item # **POS-**\_\_\_\_  
Size

Oz. **\$1.29**  
1/8 **per bag**  
3/16 **\$10.99**  
1/4 **per box**  
3/8 **of 12 bags**  
1/2

### Round Split-Sinkers

Item # **SS-**\_\_\_\_  
Size



Size BB  
3/0 **\$1.29**  
7 **per bag**  
5 **\$10.99**  
4 **per box**  
3 **of 12 bags**  
2

### Dollar Sinkers

Donut Shape  
Resists  
Currents



Also  
Called  
River  
Sinkers

Item # **DSRS-**\_\_\_\_  
Size

Oz.  
1, 2, 3, or 4

5# **\$14.99**



FLAT  
BANK  
SINKER

1, 2, 3, 4, 5, 6, 8 oz.



BELL  
SINKER

1, 1 1/2 oz.

NO ROLL SINKER



1, 1 1/2, 2, 3, 4, 5, 6, 8 oz.



CANNONBALL  
SINKER

5# **\$14.99**

For Bottom Bouncing  
1, 2, 3, 4, 5, 6 oz.



NO SNAG  
SINKER

1, 1 1/2, 2, 3, 4 oz.

Your  
Choice

5 LBS.  
**\$13.99**



5# **\$14.99**

BASS CAST  
SINKER

3/4, 1, 1 1/2, 2, 3, 4, 5 oz.

To Order: [www.grizzlyjig.com](http://www.grizzlyjig.com)



# Bait Nets & Accessories

AERATION SYSTEMS, NETS, TRAPS, AND WIRE BASKETS

## REPLACEMENT NETS



Item #	Fits (diameter)	Mesh	Depth	Net Material
RN-501B	28"-30"	3/8"	24"	Dura-Soft Mesh Dipped (Catch & Release/Snag Free)
RN-615	14"-18"	1"	10"	Rubber (Catch & Release/Snag Free)
RN-622	20"-24"	1"	14"	Rubber (Catch & Release/Snag Free)
RN-628	26"-30"	1 1/4"	20"	Rubber (Catch & Release/Snag Free)
RN-700	16"	3/4"	24"	Black Poly
RN-710	18"	1"	26"	Black Poly
RN-712	24"	1"	30"	Black Poly
RN-720	24"	1 1/4"	30"	Black Poly
RN-722	28"	1 1/4"	36"	Black Poly
RN-724	30"	1 1/4"	40"	Black Poly
RN-726	38"	1 1/4"	46"	Black Poly
RN-730	32"	1 1/2"	40"	Black Poly
RN-732	40"	1 1/2"	46"	Black Poly

## HOOK RESIST

RN-500BR	37-40	3/4"	40"	Black Coated Mesh
RN-501BR	28-30	3/4"	35"	Black Coated Mesh
RN-502BR	20-24	3/4"	24"	Black Coated Mesh
RN-503BR	18-20	3/4"	20"	Black Coated Mesh

## 400 Series Cast Nets (5/8" Mono)

### Application 6"-12" Bait

With 1.15 lbs of actual lead weight per foot and more Braille Lines and stronger mono, these nets are designed for use in deep water or strong currents. The 400 Series Nets feature Premium Green UBE Chip Monofilament Netting, 5/8" square mesh, and 90 lbs test Braille Lines. A long 30 ft handline is secured with a commercial grade anodized swivel. Each net is packed in an attractive reusable hard-shelled plastic container.

Net Size: 5 FT 6 FT

Model #: CN-405 CN-406

#CN405 \$52.95

#CN406 \$59.95



## 600 Series Cast Nets (1/4" Mono)

### Application 1-5" size Bait

The 600 Series Cast Nets are designed with 1/4" square mesh, 100 lbs test Braille Lines and 1.35 lbs of actual lead weight per foot. All 600 series nets are outfitted with round ball weights, which improve on the fine-tuned sink to weight ratio of all Ahi USA nets. A long 30 ft handline is secured with a commercial grade anodized swivel. Each net is packed in a durable plastic container or bucket, which also works great for holding bait.

Net Size: 5 FT 6 FT

#CN-605 \$78.95

#CN-606 \$86.95



## BAIT MOTEL

Deluxe Bait Motels feature larger more buoyant float rings and black heavy duty mesh.

NE-738 boasts massive storage capacity, triple float rings, and dual heavy duty handles for securing to docks or piers. Great for holding bait for extended periods of time.

#NE-738

36"x38"

165 Gallons

**\$99.<sup>99</sup>**

**OVERSIZE SHIPPING**



## BAIT MOTEL

NE-750

18"X28"

30 GALLONS

**\$21.95**



To Order: 1-800-305-9866

## 2 SPEED BAIT AERATORS



**AC-710**  
Runs for 30 hrs on 1 "D" battery.

**\$12.99**

## BAIT DEALER / SCIENTIFIC NET

These bait dealer and multipurpose nets feature the *ProtecNet* system designed with the net secured internally within the frame, eliminating abrasion on the net material. Great for minnows, shrimp, and shiners.

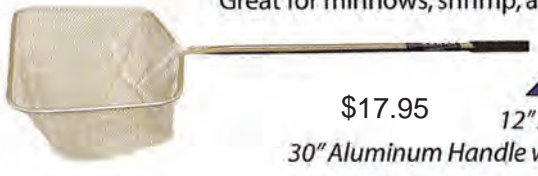

**\$17.95**  
**LN-412**  
12" X 16" Hoop  
30" Aluminum Handle w/ EVA Grip

## MINNOW SEINES

These heavy duty seine nets come assembled with floats and weights. Made from durable treated 1/4" poly coated black nylon. Great for catching your own bait from shore. 6 sizes to choose from.

*Requires 2 rigid poles measuring no less than 5 ft in length.*

- MS-408** - 4' x 8' \$15.95
- MS-410** - 4' x 10' \$17.99
- MS-412** - 4' x 12' \$21.99
- MS-420** - 4' x 20' \$36.99
- MS-425** - 4' x 25' \$47.95
- MS-450** - 4' x 50' \$74.95



## Angler Series Nets



- Octagon handles
  - Molded grip
- Small LN900 \$10.99**  
17" hoop  
18" handle
- Medium LN910 \$14.99**  
20" hoop  
30" handle
- Large LN920 \$17.99**  
24" hoop  
36" handle

## LIVE BAIT TRAPS

### Minnow Trap



**\$9.99**

**TR-501**  
18" x 10"  
Dual 2 1/2" Entrances

### Rice Slick/Crab/Crawdada Trap

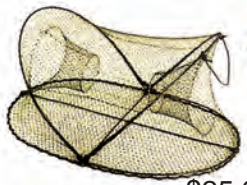

**\$25.99**

**TR-301**  
32" Length  
20" Width  
12" Height  
(dual 4 3/4" ring entrances)

### Rice Slick and Other Bait Fish



**\$18.95**

**TR-503**  
24" x 12"  
Dual 5" Entrances



All traps collapse to this size.

## WIRE FISH BASKET

Fully collapsible, these wire baskets feature spring-loaded trap doors on top and bottom for easy loading and unloading. Costructed of 5/8" wire mesh. Floating model also available.



**WB-13**  
**\$6.95**  
13" diameter  
18" height



**WB-14**  
**\$8.95**  
14" diameter  
24" height



**WB-14F**  
**\$9.95**  
14" diameter  
24" height  
(Floating lid)



**WB-19F**  
**\$14.95**  
19" diameter  
30" height  
(Floating lid)



# ENGEL

**A Legend in Reliability**



## Engel Live Bait Cooler

Model	SIZE	PRICE
#ENGLBC7.5	7.5 QT	\$59.99
#ENGLBC13	13 QT	\$64.99
#ENGLBC19	19 QT	\$69.99
#ENGLBC30	30 QT	\$79.99
#ENG-AP	Pump	\$24.99

## Engel Strainers for Live Bait Coolers

Velcro tabs for storage in your cooler lid.



Change water quick and easy.

#ES-13QT	\$15.95
#ES-19QT	\$17.95
#ES-30QT	\$19.95



## Minnow Net

#UCNET-13QT	\$7.99
#UCNET-19QT	\$8.99
#UCNET-30QT	\$9.99



## Minnow Holding Tray

#UCTRAY-13QT	\$7.99
#UCTRAY-19QT	\$8.99
#UCTRAY-30QT	\$9.99

## Engel's Deep Blue Performance Cooler



Left: Engel compared to a Yeti Cooler

Model	SIZE	PRICE
#ENG-25TAN	25 QT	\$159.99
#ENG-35TAN	35 QT	\$199.99
#ENG-50TAN	50 QT	\$229.99
#ENG-65TAN	65 QT	\$279.99
#ENG-80TAN	80 QT	\$299.99
#ENG-123TAN	123 QT	\$399.99

## Cooler/Dry Boxes



Pink with Shoulder Strap

Model	SIZE	PRICE
#UC7.5P	7.5 QT	\$44.95
#UC13P	13 QT	\$49.95
#UC19P	19 QT	\$59.95
#UC30P	30 QT	\$69.95

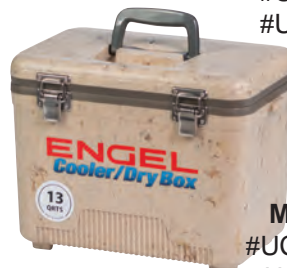

Grassland Camo with Shoulder Strap

Model	SIZE	PRICE
#UC7.5C1	7.5 QT	\$44.95
#UC13C1	13 QT	\$49.95
#UC19C1	19 QT	\$59.95
#UC30C1	30 QT	\$69.95

To Order: 1-800-305-9866



**The Livewell Aeration Company**



**Bubbles**

- Precision motor runs 85 hours on 2 alkaline "D" cell batteries
- Booted waterproof switch
- Weighted glass bead airstone with 30" of air line tubing
- Made in America
- Space saver package

5-5/8"x9-1/2"x2-1/8"D  
Stock #B-3  
Bubbles  
\$19.95

**Bubble Box**

- Exceptional customer value
- Runs up to 33 hours on 2 alkaline "D" cell batteries
- Space saver clam shell package

3-7/8"x7-1/2"x2-2"D  
Stock #B-11  
Bubble Box  
\$9.95

**Quiet Bubbles**

- Exceptionally quiet air pump
- Booted waterproof switch
- Runs up to 33 hours on 2 alkaline "D" cell batteries
- Space saver clam shell package

3-7/8"x7-1/2"x2"D  
Stock #B-14 Quiet Bubbles  
\$16.95

**2 Way Bubbles**

- Extremely quiet
- Runs up to 52 hours on 2 alkaline "D" cell batteries
- Comes with a 12 volt DC adapter
- Will operate on a 110 volt adapter (not included)

Available at your local Radio Shack  
Stock #B-17  
\$29.95

**Super Saver**

12 volt D.C. bilge pump and aerator kit - complete system

- Mounts with suction cups or screws in any livewell
- Most versatile - 1) Pumps water in, 2) Aerates, 3) Emergency bilge pump, 4) Pumps water out and washes down
- Keeps fish lively
- Fresh or salt water
- New non-toxic fish foam filter



Stock #SS212  
\$42.95

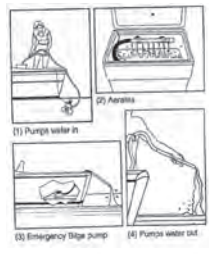

Spare Filter  
#SCOO \$4.49

\$16.95



A-1



A-2

\$24.95

Stock #	Tank size Gallons	Pump Volume STL/min	Outlets
A-1	5-15	1.3	1
A-2	20-50	5.0	2
A-3	100	5.5	2



**110 Volt Bubbles**

\$56.95

Included in A-3 kit

Increase the capacity of up to 2 livewells by saturating the water with oxygen from this quiet, powerful 12V air pump. Operates on only 1/4 amp. Can be easily wired directly to boat panel. Most effective when used with a water renewal system. Complete kit includes pump with 6' power cord and copper battery clips, 10' airline tubing, antisiphon valves, and large air stones.

#PB \$42.95

**Power Bubbles™**



**Super Bait Saver™**

Operating on only 3/4 amp, these low profile livewells include a durable poly well with molded handles, hinged lid, and cutting board tip. Ultrasonically sealed motor comes with 6' cord, copper clips, and filter. Tank tested. Made in the USA.  
\$79.95 10 Gal. Item  
\$99.95 20 Gal. Item

**Cool Bubbles™**



This 11-1/2-qt. insulated pail with detachable Bubbles Air Pump maintains constant water temperature and proper aeration. Runs up to 85 hours on 2 D cell batteries (not included). Includes 30" of air tubing and a weighted glass-bead air stone. Made in the USA.

CB3 11QT \$47.95  
CB35 5GAL \$51.99  
CB211 8QT \$26.99

- A. Stock #CB-3 - Cool Bubbles w/ Bubbles Pump (water resistant)
- B. Stock #CB-35 - 5 Gal. Cool Bubbles w/ Bubbles Pump
- C. Stock #CB-211 - 8 Qt. with Bubble Box and Net (not pictured)

**Baby Bubbles**

- ±20 hours on 1 or 2 AA Batteries
- Aerates up to 3 gallons
- Back up aquarium pump
- Fresh or Saltwater

Stock #B-18  
\$6.99



## Fish Saver

- 12 VDC livewell aerating system
- Pump attaches with suction cups to all non-porous surfaces--no drilling or screws
- Can be used in styrofoam containers by mounting smooth plastic base
- Spray tube may be cut or lengthened to fit different containers
- Certified non-toxic Fish Foam filter
- Low current -- up to 1-3/4 amps
- Complete ready to use system with copper battery clips
- Aerates 10 to 25 gallons
- Made in America

**FS-4 \$29.95**



- Includes:
- (2) Tool Holder Straps
  - (2) Thru-the-side or Top Airline Fittings
  - (8) 10 x 1/2" Stainless Steel Screws
  - (8) 2" Suction Cups
  - (1) Weighted Air Stone
  - (1) Bubble Box Aeration Pump (batteries not included)
  - 24" of Air Line Tubing
  - \*Cooler Not Included

## Bubble Donut Air Stone Diffuser



**ABS-5- 5" Stone \$6.99**  
**ABS-3- 3" Stone \$4.69**

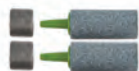

AS-01



AS-00



AT-6



L-5

## Bubble Box Livewell Kit

Build Your Own Live Bait Cooler

**#LWK-11 \$19.99**



**Silicone Air Line Tubing- 6' Stock # AT-6 \$2.99**

**Bubbles Top- Universal 5 gallon lid w/ accessory tabs Stock # L-5 \$9.99**

**Glass Bead Air Diffusers- (Pair) Made in USA Stock # AS-00 \$3.29**

**Glass Bead Air Diffusers- w/ weight (Pair) Stock # AS-01 \$3.99**

## Rule Aerator Pumps

For thru-hull application, angled 4" pickup tube and 3/4" discharge.

**401C (DMI#581757) 500 GPH Angled Pump \$64.95**

**403C (DMI#581810) 800 GPH Angled Pump \$69.50**



ANGLE PUMP

## Tsunami Recirc Aerator Kit

**#4253-7 \$48.95**

The Tsunami Recirc Kit recirculates livewell water to keep it cooler and rich in oxygen. This self-contained system feeds a separate aerator spray head and works even while you are underway and cannot use a thru-hull connection. Add this kit to any tank that already has a freshwater fill system. Or use as a backup pump for a fail-safe system.

Recirc Kit includes:

- 500 GPH Tsunami aerator pump with short inlet, threaded outlet
- 4125-1 aerator spray head
- 4232-1 stainless steel strainer
- 2 plastic hose clamps
- 3/4" dia., 23'L poly hose
- Straight thread-to-barb connector

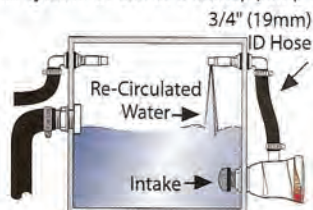

## Mesh Strainer 3/4"X14 NPSM

**#4232-1 \$7.99**



Prevent debris from clogging aerator pumps.

To Order: 1-800-305-9866



**AQUA-LIFE COOLER  
CONVERSION KIT**

**\$45.99**



#14371  
Whisper Quiet Operation

Includes everything you need to convert a cooler to a live bait tank.  
•Includes: Aerator, Hose, Bubble Defuser, Fittings, and Bracket  
•Power Options: 2 D-Cell Batteries (Not Included) 12 Volt and 110 Volt Adapters



**\$14.99**

**FRABILL PORTABLE  
AERATOR**



**\$27.95**

**MIN-O-LIFE AERATOR**



**\$36.95**

**AQUA-LIFE®  
PORTABLE AERATOR**



**\$12.99**

**FRABILL PORTABLE  
AERATOR**



**\$49.95**

**MIN-O-LIFE PERSONAL  
BAITSTATION**



**\$49.95**

**MIN-O2-LIFE AERATED  
BUCKET-4.25 GALLON**



**\$75.99**

**AQUA-LIFE™ BAIT  
STATION-6 GALLON**



**\$22.95**

**AERATION & LID  
COMBO PACK**



**\$6.99**

**AQUA-LIFE®  
ACCESSORY PACK**



**\$10.99**

**120 VOLT ADAPTOR**



**\$17.95**

**\$29.95**

**AQUA-LIFE® 110  
VOLT AERATOR**



**\$26.95**

**GALVANIZED 2-PIECE  
FLOATING BUCKET-  
8 QUART**

To Order: [www.grizzlyjig.com](http://www.grizzlyjig.com)



**BAIT COOLER FEATURES:**

- \*All of our coolers have bait-friendly rounded internal corners and center divider.
- \*Heavy-duty injection molded base with non-slip bottom
- \*1" of commercial grade foam insulation
- \*2 speed waterproof aerator allows for easy opening/closing of lid and run on (2) D-Cell batteries of included 12v plug. (30 QT has dual aerators.)
- \*Durable composite latches won't rust
- \*Large comfortable side mounted handles
- \*Integrated ruler on top

**MAGNUM BAIT STATION 19  
BAIT COOLER**



#FRBBA219  
**\$89.99**

**MAGNUM BAIT STATION 13  
BAIT COOLER**

#FRBBA213  
**\$79.99**



**NEW  
2020**

**MAGNUM BAIT STATION 30  
BAIT COOLER**



**\$129.99**

#FRBBA230



**TANGLE FREE CRANK  
BAIT BOXES**

#BB-464  
Holds 45 Bandits  
**\$49.95**  
6" x 12"

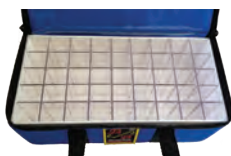

#BB-964  
Holds 96 Bandits  
**\$76.95**  
17" x 11"



By far the best  
crank bait box we  
have seen!

*Tangle free says  
it all!*

**G-Box 3200, Slit Foam Case**



- Size 8.1" x 5.7" x 1.6"
- Great for plastic baits and hard baits
- Micro Rib System- Micro Adjustable Dividers
- Easily opened with one hand
- Does not open when dropped
- Tackle stays in place and does not go to other compartments
- Rounded corners easy to get out of tackle bags or boat compartments

#G3200SF **\$9.99**

**NEW**



**G-Box 3600, Slit Foam Case**

Size 10" x 7.5" x 1.1". Great for Rigs, Hooks, Flies and Jig Heads. Easy to See Slits. Easily opened with one hand. Product stays in place and organized. Rounded corners easy to get out of tackle bags or boat compartments.

#G3600SF **\$12.99**



## Expandable Crappie Nets

Nations #1  
Selling Crappie Net



### Extendable Crappie Nets

Designed For The Savvy Angler.

#### EGO® Reach

71001  
#EG01  
**\$43.<sup>95</sup>**



- Unique Scoop Design
- Non-Tangle/Hook-Free PVC Coated Mesh
- Industry Leading Strength-to-Weight Ratio
- Telescoping Quick Twist-Lock Handle
- Product Weight: 1.8 lbs

#### Replacement Netting

PVC Coated  
#RN-PVC \$12.95

#### EGO® Reach Rubber

71002  
#EG02  
**\$49.<sup>95</sup>**



- Unique Scoop Design
- Non-Tangle/Hook-Free Mesh
- Industry Leading Strength-to-Weight Ratio
- Telescoping Quick Twist-Lock Handle
- Product Weight: 2.0 lbs

#### Replacement Netting

Rubber  
#RN-RUBBER \$15.95

#### S2 Slider Reach

72081 #EGO-S2 PVC Mesh  
**\$119.99**  
72082 #EGO-S2R Rubber  
**\$129.99**



- Innovative Grip Design
- 48" Slider Handle Extends To 108"
- Unique Scoop Design
- Flat Bottom / 16" Bag Depth
- Medium Hoop Size 17" x 19"
- Replacement Handles Available



#### Big T Duralite Crappie Net

Your Choice  
**\$99.95**

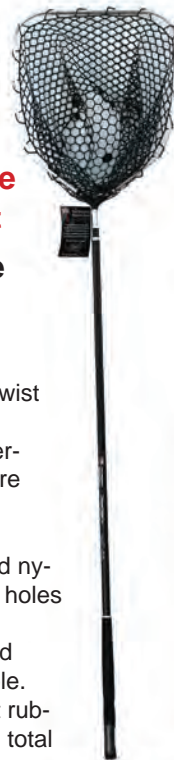

The net features a 3 piece handle with twist locking sections so that your net is fully adjustable. The net is available in 3 different models (different heads) all heads are 16"x20" and all are interchangeable.

Three Models:

**#BT01-Small Mesh** - This rubber coated nylon head is 18" deep and has small 1/4" holes that help keep those jigs in the basket.

**#BT02-Large Mesh** - This rubber coated nylon head is the lightest weight available.

**#BT03-Mesh** - this is the lightest weight rubber mesh net on the market at just 19oz total weight.

#### Big T Replacement Nets



#BTDNET-SM

#BTDNET-LM

#BTDNET-R

Your Choice **\$29.95**

#### NEW Extendable Crappie Net

- Easy Storage
- More Backbone Than Most Crappie Nets
- Twist Lock Telescopic Handle - Extends 3'-8" (96")
- Heavy Duty Yet Light (23 oz.)
- Black Mesh 19" Net
- Best Buy For Crappie Net



Photo By: Tim Huffman

To Order: [www.grizzlyjig.com](http://www.grizzlyjig.com)

**Big Mouth Round Cricket Box**

CCA1 \$3.99

Color may change.



**Long Cricket Tube**

CCA2 \$3.69



**Short Cricket Tube**

CCA3 \$2.99



**Plastic Cricket Basket**

Twist-Top

CC50

\$1.67



**Boatwell Nets**

14 1/2" Aluminum Handle



#BN-15A  
\$6.69

**Minnow Dip Nets**

\$4.95 DZ

Import

White



Nylon mesh aquarium net.  
Comes 12 nets per pack/  
Priced per each  
WNDB.....\$6.99 EA  
WNDB-DZ.....\$5.95

**CUBA FRANKLIN Galvanized Minnow Trap**  
#GG40 \$14.95



**Promar Black Coated**

Minnow Trap  
#TR601

Crawfish/Pond Perch  
Oversize Throat  
#TR-601L

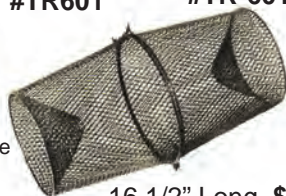

16 1/2" Long \$10.99

**Small Boatwell Net**

SMALL  
5"x6"  
14"  
Glass  
Handle  
BWN-10

LARGE  
8"x10"  
18"  
Glass  
Handle  
BWN-20



BWN-10 \$3.99  
BWN-20 \$6.49

**Wood Handle**

7"x7"

16"  
Handle

BWN18W  
\$3.69



**Minnow Dippers Assorted Colors**

\$8.99  
1 Dz.

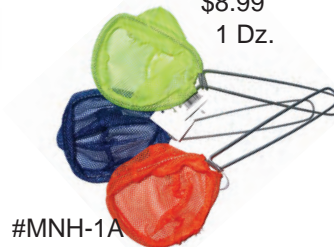

#MNH-1A

**Heavy Duty (USA) Minnow Dip Net**



\$1.69 ea  
11 1/2"x4"x5"

Large  
MN-1B  
\$2.49



4 1/2x6" Hoop  
16" Long  
Blue Coated Handle



**Reelfoot Lake SOUTHSHORE FAMILY RESORT**

**FISHING PACKAGE SPECIAL**

Three Days & Three Nights  
\$289.00 per person

- Fishing Tips.
- Room with furnished kitchen.
- 14 ft. or 16 ft. boat, motor and gas for the three days.
- \$10.00 worth of minnows, worms, or crickets each day, per boat.
- Ice to pack fish and cool drinks.
- Barbecue grills, and picnic tables available (charcoal not included).
- Check-out is 12:00 noon.
- Check-in is 3:00 p.m. (or before if available).
- Minimum number of people for this package is 2.

**Reservations must be confirmed with a deposit of \$75.00 per person.**

We accept VISA-MasterCard-Discover American Express

**SUMMER & FALL FISHING PACKAGE**

2 Days & 2 Nights \$159.00/person  
3 Days & 3 Nights \$199.00/person



*Southshore Family Resort*  
PO Box 121 ~ 601 East Lakeview Dr.  
~Samburg, TN 38254~

Ph: 731-538-2467

Fax # 731-538-9757

[www.southshorerestort-reelfoot.com](http://www.southshorerestort-reelfoot.com)

*Boat House Restaurant just across the street.*

**STANDARD RATES**  
Motel - \$90.00 per night for 2 or fewer people.  
Cabin - \$90.00 per night for 2 or fewer people.  
Lodge - \$270.00 per night for 6 or fewer people.  
Lakeside Cottage - \$180 per night for 4 or fewer people.  
Bunk House - \$160.00 per night for 6 or fewer people.  
\$25 CHARGE FOR EACH ADDITIONAL PERSON 12 YEARS OF AGE AND OVER. CHILDREN UNDER 12 FREE

### Boat Cushions



- Make sure your boat is legal with this U.S. Coast Guard approved throwable cushion.
- Convenient webbing grab straps aid in throwing and double as carry handles.
- Functional and comfortable PE foam.
- Strong, durable outer shell withstands abrasions.
- USCG Approved Type IV.

#BC-BLUE \$12.99  
 #BC-RED \$12.99  
 #BC-CAMO \$16.99

### Life Jacket I-Belt Orange Your Choice \$9.99

- #586682 Infant/Child (under 50 lb.)
- #586670 Youth (50-90 lb.)
- #586666 Adult (over 90 lb.)
- #586644 Oversize (over 90 lb.)
- For your everyday boating needs.
- USCG Approved Type II.



### Marpac Xtreme 33 Gram Adult Inflatable Life Vests



8-0306



8-0304

- US Coast Guard Approved Type III performance, Type V when worn.
- Lightweight and less restrictive than other PFD's.
- Neoprene collar and mesh back for cool comfort.
- One size fits all.
- Bright yellow inflation cell with SOLAS reflective tape for extra visibility.
- Safety whistle included.
- An excellent choice for a full day on the water

#### Manual (Not Pictured)

8-0314 Black/Blue \$89.99  
 8-0316 Black/Red \$89.99  
 593998 (42842) Re-Arm Kit \$21.99

#### Automatic

8-0304 Blue/Black \$99.99  
 8-0306 Red/Black \$99.99  
 593990 (42843) Re-Arm Kit \$34.99



### XTREME Manual Inflatable Life Vest



8-0330

- US Coast Guard Approved Type III performance, Type V when worn.
- Lightweight and less restrictive than other PFD's
- One size fits all.
- Comfortable fit with a neoprene collar, minimal weight around the neck and strap placement.
- Bright yellow inflation cell with SOLAS reflective tape for extra visibility.
- Safety whistle included.
- An excellent choice for a full day on the water.

Order No. Color  
 8-0330 Camouflage \$98.99  
 593996 (42840) Re-Arm Kit \$21.99

### Bilge Pump Float Switch



#57438  
 \$9.99

- Activates pump automatic
- Universal 10 amp 13.5 volt
- Submersible



### TSUNAMI SERIES Cartridge Bilge Pumps



500GPH #4606-7 \$19.99  
 800 GPH #4608-7 \$27.99  
 1200GPH #4612-7 \$36.99

### Johnson Livewell Aeration Pumps

Made In  
USA

Replacement  
Cartridge Available

Replaces old Mayfair models.



500GPH #38502  
 \$39.95

750GPH #38702  
 \$47.95



INLINE 500GPH #28502  
 \$39.95

750GPH #28702  
 \$47.95

To Order: [www.grizzlyjig.com](http://www.grizzlyjig.com)





MARINE AUDIO TECHNOLOGY

# HYDROWAVE

ACCESSORIES

**NEW!!**



Power Speaker Plug

Power & Menu

Play & Pause

LCD Screen

Volume Up

Delay Options

Volume Down

#HW-PKG-H2MRCRAP

**\$359.99**

- 8 Sound Patterns
- Waterproof Speaker
- 16 Bit-CD Quality Sound
- 5 Pre-Programmed Delay Options (15/30/45/60/120)
- 14 Foot Cord
- Expansion Port for Additional Sounds
- Lateral & Vibration Reaction Technology
- 2.5" LCD Display
- Made in the USA

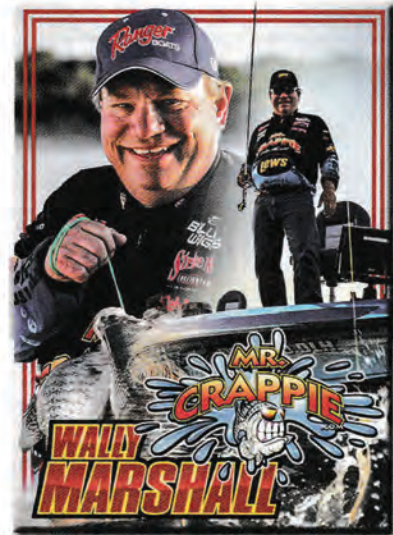

"Hey Crappie anglers! The all New Mr. Crappie HydroWave has all natural Live Action sounds of Crappie Feeding and Bait Fish!

**\$69.99**

## MR. CRAPPIE

**NEW!!** Designed by Mr. Crappie, Wally Marshall, to be the Ultimate Crappie Fishing Light



Wally Marshall says, "The Mr. Crappie Bait Blaster will have you catching crappie at night just like a pro! Mr. Crappie Bait Blaster is great for nighttime crappie fishing and is awesome under docks. The Mr. Crappie Bait Blaster will draw millions of baitfish and crappie within minutes."

### Mr. Crappie® Bait Blaster Underwater Light

- 18' Power Cable, Weighted to Maintain the Desired Depth Range
- Green LED Lights for Maximum Fish Attraction
- 360 Degree Light Output
- 180 LED Design

LED-34143 Mr. Crappie Bait Blaster Underwater Light

### Wave Away - Sonar & GPS Screen Cleaning Kit

**NEW!!**

- Specially Formulated to Clean and Protect LCD Screens
- Alcohol and Ammonia Free
- Sticks Where it is Sprayed - Resists Dripping into Sensitive Electronics
- Also Cleans Sunglasses, Cell Phones, Auto Nav Screens, LCD/LED Plasma TVs, Computer Screens & MP3 Players
- Kit Includes Screen Cleaner, 12"x12" Microfiber Cloth and Velvet Drawstring Bag

Part #	Description
WAVE-15KIT-DP	Wave Away - 1.5 ounce kit
WAVE-27KIT-DP	Wave Away - 2.7 ounce kit

**1.5 oz - \$9.99**  
**2.7 oz - \$11.99**





# Copper Bells

1 per Package  
Part No. CFB-1 69¢ ea

This copper bell transmits a sound that alerts you to the slightest strike. The bell easily clips onto the rod tip.



## ALL PURPOSE FISHING GLOW BELLS

with Lightstick Holder

The HT Glow Bells easily attach to any tip-up flag wire. When the fish hits, the bells and the fluorescent glow alert you

Part No. LFB-1 99¢ pk  
1 per pkg

## JIG EYE CLEANER w/ Line Cutter Kit

Eagle Claw #TACCKIT1 \$4.99  
Eagle Claw #JECEC \$2.49 (insulated Red)



## Economy Fish Scaler 7"



TFS-01 \$1.00

## Dumbbell Marker Buoy



ORANGE  
#AMDB \$7.49

## Deluxe Rubber Handle Scaler



03030-02 \$2.99



## Jig Eye Cleaner Line Clipper Hook Sharpener

## Marker Buoy



FLOW-ORANGE  
#MBSQ \$3.49

## HT Fish Skinners



This standard skinner has coated handles.

FSK-1 \$2.99

Titanium Coated SS



95087TT-C  
\$10.95

## Portable Potty

#APJ \$3.99



#APJF Female Adapter \$1.99

## Fisherman's Pliers



LNF-6 6" Pliers \$3.49  
LNF-8 8" Pliers \$3.99  
FP-8SS 8" Stainless Steel Pliers with Heavy Tight Jaws for Bigger Fish \$6.99



# EAGLE CLAW®

## Deluxe Skinning Pliers



1 1/2" Jaws  
Coated Handles

#03020-007 \$4.99

## 110# Heavy Duty Digital Scale

#SDS1 \$23.99



## The Ultimate Line Winding System

#GLS1 \$34.95

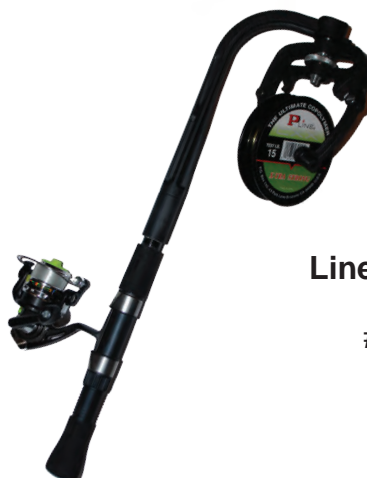

# Accessories

**Eagle Claw Lip Grip**  
 #TLGSC  
**\$34.95**



- Locking Jaw
- 30# Scales
- Stainless
- Nylon Lanyard

**Tournament Culling Beam**  
 #EGO-TCB  
 73009 \$27.95



Take out the guess work.

**Hi-Tech Hook Remover**  
 #DHR-1  
**\$2.95**

Dislodge The Deepest Hooks



**Berkley Fillet Board**

- Corrosion Resistant Clamp
- Quick Clean Non-Porous Surface
- Slim Grooves to Prevent Buildup



1318307  
 #BCFB  
**\$10.95**

**LITTLE STINKER FISH-A-NOODLE**  
 3" X 15"



\$9.99  
 #LS-NY3 3 PK

**Doc's Catfish Worm Remover**  
 CB-D-11201  
 #DOC-REM  
**\$3.99**

THE ORIGINAL



**Lighter Buoy Marker**  
 #BMK-1L  
**\$5.99**



Comes with 6 - 3" glow sticks.

**Quik Clench Fishing Pole Ties**

#QC02  
**\$2.99**  
 2 PK  
 #QC12  
**\$14.99**  
 12 PK



- Easy to Adjust Push Button
- Floats

**Hook Removers**

HD-10 Large  
 HD-1 Slim



LARGE  
 SLIM

Your Choice  
**\$1.00**

**Berkley Floating Fish Lamp**

- 12V Power Source
- 8 ft Cord w/ Battery Clips



1318321  
 #BTFL  
**\$12.99**

**Berkley Submersible LED Fishing Light 12 Volt**



- 30' Power Cord w/ Clips
- 6 Green LED Lights
- Fresh or Salt Water

1404104  
 #BBMSL **\$29.99**

**Eagle Claw Split Ring Pliers with Braid Cutter**



#TLSR  
**\$6.99**

5 1/4" Stainless

# For the Live-Bait Fisherman

## Styrofoam Champagne Bucket

5 Gallon  
Bucket Liner  
#CSL5



\$7.99



S-10  
Replacement Bucket  
Only \$7.99

### Minnow Bucket



8 Qt  
Turbo-Troll  
#MB-50114  
\$9.99

### Foam-Off



8 oz. bottle removes harmful surface foam from bait tanks, transport trucks, vats and livewells.  
SL131.....\$11.99

### Please Release Me



by Sure Life  
\$12.95  
#SL-153  
10-oz.

The ultimate stress reducing livewell additive.

### Shad Keeper

3# Jar  
SL183  
\$16.99



### Better Bait™ Minnow Holding Formula

- Condition Water
- Removes Chlorine
- Keeps Bait Frisky
- Lower Bait Loss
- Simulates a Natural Slime Coat
- Removes Heavy Metals
- Reduces Fungus and bacteria
- Adds Electrolyte
- Available in 3, 12, and 36 lb.



Order No.	Treats Gallons	Size	Price
SL102	500	10 oz.	\$14.99
SL103	2,400	3 lbs.	23.99
SL104	9,600	12 lbs.	79.99
SL105	28,800	36 lbs.	179.99



Mr. Crappie Brand

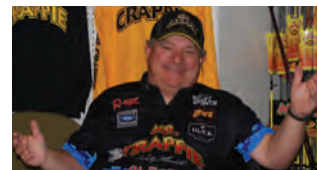

### Minnow Tank and Live Well Treatment Crappie Care

-8 drops for average minnow bucket  
-1/2 oz. treats 30 gallons



1 oz.      8 oz.      1/2 Gal-64 oz.  
1 Gal-128 oz.

Part #	Size	Price
U2C1-FW	1 OZ.	\$ 3.99
U2C8-FW	8 OZ.	\$11.99
USC64-FW	64 OZ.	\$41.95
USC128-FW	128 OZ.	\$69.95

**Mark your calendars!**

**Tentative date for the Grizzly Jig Spring Tackle Show**  
Jan. 28-31, 2021



\$6.49

**FISH COUNTER**

#SLEMAFC



Great for counting anything!

**Measuring Board  
22" BENCHMARK®**



#1551

**\$14.95**



PLASTIC



**Slater's**

**No. SSP  
SLATER'S  
SCULLING PADDLE**

Strong-Light-Tough and it Floats! All the advantages of wood with none of the disadvantages. Made of solid plastic so it won't warp, crack, rot or waterlog. Weighs approximately the same as a wooden paddle.

- SSP-30" \$11.99
- SSP-36" \$12.99
- SBP-42" \$13.99

**EZ CRAPPIE**

#1440-EZ



**\$9.95**

**\$6.99**

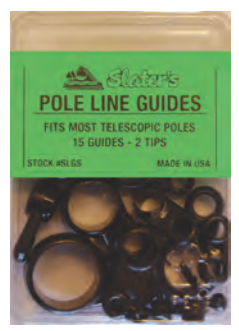

**No. SLGS SLATER  
LINE GUIDE SET**

Without a doubt, the most durable and economical line guide set on the market today. A complete set that includes 15 line guides and 2 tip guides and will outfit any Slater Pole or most any other telescopic pole. Made of tough Lexan for durability and to prevent line fray. Packaged in a hang-tab plastic box.

**Rod Tip Repair Kit**



- |          |          |             |
|----------|----------|-------------|
| #BTAEC   | #GTAEC   | #AHDTK      |
| Black    | Gold     | Black       |
| \$3.99   | \$3.99   | \$4.29      |
| Sz 6,7,8 | Sz 6,7,8 | Sz 10,12,14 |

**Eagle Claw  
Reel Oil**



#ReelO  
**\$3.95**

**Eagle Claw  
Reel Grease**



#REELG **\$3.95**



**YO-YO**  
**\$32.99**  
DZ

\$2.<sup>69</sup>  
each



**Renegade  
Pro Series**

6" Locking  
Pliers

#HEM6W  
**\$3.69**



5" Curved Tip

#HEM5P  
**\$2.69**

SS-Plain

Soft Touch  
Handles

**COMAL  
8 mm (1/4") Red Beads**



RB8  
**\$1.00**  
20 pk

To Order: 1-800-305-9866

### Magnum Series

- Designed for boat control in extreme conditions
- Rip-Stop nylon fabric reduces rippling and pulsing
- Provides more drag than other drift socks of the same diameter

Item	Size	Price
DCMS40	40"	\$69.99
DCMS48	48"	\$79.99
DCMS60	60"	\$96.99
<i>DCHB15 Harness Buoy Included</i>		



### Original Series

The Lindy Original Series Drift Sock deploys easily, packs small and can save your fishing trip when the wind blows. The upper cylinder of the Original Series features flotation material, while the bottom is weighted, so this sock opens fast and resists rotation. The 1-inch nylon straps offer added and sure support, and resist rot for years of carefree use.

### Harness Buoy

- Six-foot Harness Buoy
- Rubber-coated, stainless steel clip
- Blaze-orange buoy for high visibility
- Comes with a 20' dump line

DCHB15	Harness	\$22.95
--------	---------	---------



Item	Size	Price
DCSS25	25"	\$46.99
DCSS40	40"	\$52.99
DCSS50	50"	\$59.99
DCSS60	60"	\$69.99

### Wave Tamer Drift Socks

- Spring-open design
- Easy deployment and hassle-free retrieval
- Perfect boat control
- No assembly required
- Tough enough for trolling
- Use to stabilize and position your boat
- Saltwater resistant fabric

Item	Price
72" WT072	\$94.95



### Fisherman Series

- Deploy quickly
- Retrieve easily without tangling and spinning
- Reinforced nylon prevents fraying

Item	Size	Price
DCVS30	30"	\$28.95
DCVS36	36"	\$32.95
DCVS42	42"	\$36.95
DCVS48	48"	\$42.95
DCVS54	54"	\$49.95



**DRIFT SOCK**

Slow down your drift to enable proper bait presentation over holding fish with Minn Kota's Drift Sock, designed with durable construction. The MKA-27 features built-in weights and floats, allowing it to automatically open when placed in the water.

1865262  
**MKA-28 \$29.95**  
Drift Sock Harness  
w/ Buoy

**\$38.99**

MKA-26

- 34" deep x 22" diameter
- 210 denier ripstop nylon
- Four heavy-duty 1" nylon straps

1865260

**\$48.99**

MKA-27

- 34" deep x 22" diameter
- 420 denier ripstop nylon
- Four heavy-duty 1" nylon straps
- Built-in weights/floats

1865261

# Electric Fisherman®

Spend More Time Fishing & Less Time Cleaning Fish

**Rated #1**

- Lightweight, comfortable handle design for better control.
- Extra sharp blade for fast, easy filleting.
- Durable, expandable curly power cord.
- Quick & convenient blade release.
- Heavy duty motor for longer life.
- High impact motor housing.
- Safety lock.



**The fillet knife fishermen ask for by name!**

**Accessories**

Mr. Twister® Electric Fisherman®	Stock no.	Price ea.
Electric Fisherman® 1 to a package	MT-1201	\$28.99
7" Replacement Blade	RB-1201	\$12.99
NEW 8" Max Flex (New Serration)	RB-8MFB	\$15.99
9" Replacement Blade	RB-1209	\$13.99
Carrying Case (overall length 14 1/2")	KC-1201	\$10.99

## Saltwater & Freshwater

# PIRANHA

**"Bad to the Bone"**

Saltwater and trophy freshwater fishermen have a fillet knife that can handle any big fish in the Piranha from Mister Twister®, the pioneer in electric fish cleaning technology. Every bit as rugged as the classic Mister Twister® Electric Fisherman®, the Piranha, features 25% more torque and 15% more speed than most other electric knives, so it will handle the tough scales and skin of any trophy fish. The real key to its cutting power is in its 9" heavy duty stainless steel blade. More power, more torque, and more speed make the Piranha, "Bad to the Bone!" The Mister Twister® Piranha...

*Superior mechanics means superior results.*

**More Power**

**More Torque**

**More Speed**

Increased blade length means less time cleaning fish and more time on the water. Perfect for all trophy fish!

Durable, expandable power cord



**NEW Spare 8" Max Flex Shark Style**

New serration fits both Mr. Twister knives.

**RB-8MFB \$15.99**

### Guide Tested and Recommended

Mister Twister® PIRANHA	Stock no.	Price ea.
PIRANHA Fillet Knife, 1 to a package	MT-1208	\$42.95
9" Replacement Blade	RB-1209	\$13.99

## AMERICAN ANGLER

PREMIUM FILLET KNIVES & TOOLS

110 Volt



**USA**  
**2X Torque**

**#AEK-OB-RB-003-1 Knife, Vinyl Case, 8" Blade \$99.99**

### AEB-KB

Spare Blades Fit All American Angler Knives  
#CL-001-1 Standard 8" Curved Blade \$16.99



#CL-001-4 5.5" Curved Blade \$16.99



#CL-001-2 Heavy Duty 8" Shark Blade \$16.99



#CL-001-3 Heavy Duty 10" Shark Blade \$19.99



#CL-001-5 Heavy Duty 10" Catfish Blade \$21.95



## AMERICAN ANGLER

PREMIUM FILLET KNIVES & TOOLS

**ti Titanium USA**  
**110 Volt 2X Torque**



**#AMK-KM-RB-003-1 Knife, Mesh Case, 8" Ti Blade \$119.99**

### Titanium Blades

Fits all American Angler Knives

**AEB-KB**  
**#CL-001-6**

8" Ti Curved Blade  
Price \$24.95



**AEB-KB**  
**#CL-001-7**

8" Ti Shark Blade  
Price \$24.95



**GRIP CHECK**  
Fish Measurer

PROUDLY MADE IN THE USA

**STOP THE FLOP**

**NEW PRICE**  
**\$10.99**

Measures up to 13" fish!

"Curved thumb press" stops the flop and protects the fish.

The official measurer of

**CRAPPIE MASTERS**  
TEAM TOURNAMENT TACKLE

#GRIP

**Rock-It™ Automatic Fish Scaler**

#ROCKIT1 \$89.95



**Porcupine Fish ATTRACTOR**

Item	Size	Water Depth	Price
PP5.5	5'	10' or deeper	\$39.95

**Sphere 3-Pack**  
Use 1/2" PVC to custom design your own habitat.

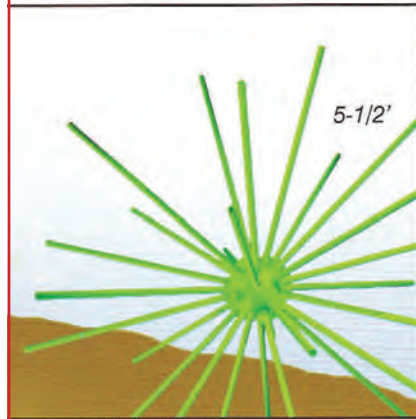

**PS-3**  
**\$29.95**

**1 Sphere PS-1**  
**\$12.95**

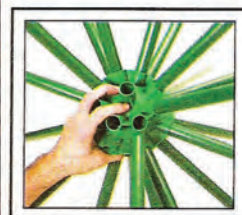

BY:



**Lighted Bump Board**

**FishPick**



- Hook Remover
- Knife Sharpener
- Hook Sharpener
- Grit 750 & 1200

100% Diamond Coated

#97053-B

**\$17.99**



- Measure Fish Anytime
- 10 LED Lights
- 20" x 1/4"
- 50 CM x 1 CM
- Auto Time for Power Off

#97100-C

**\$29.99**



1-877-BLUEBANK  
WWW.BLUEBANKRESORT.COM



REELFOOT LAKE, TN

# BLUE BANK RESORT

## CRAPPIE

PRO GUIDES

## BASS FISHING

## & MUCH MORE

Lakeside Lodging, Fine Dining

18,000 ACRES  
OF PRIME  
FISHING, HUNTING  
& EAGLE  
WATCHING

FISHING PACKAGES INCLUDE:  
LODGING, BOAT, MOTOR, BAIT, GAS & ICE



### Large Ladle

Item # 1886  
\$29.30



With the capability of holding 8.5 lbs of lead, this ladle is designed to be utilized for our large cavity molds. 5" diameter. Steel construction. Right and left pouring lips. 18" handle.

### Lyman Casting Ladle

Item # 2867790  
\$26.95



Features a wooden handle on a steel shank attached to a cast iron pour spout for easy and accurate pouring. Lead capacity is 4-1/2 oz.

### Cast Iron Ladle

Item # 1905      Item #1911  
\$16.95          \$17.95



The 1905 ladle has a 3 " diameter cup to hold up to 1-1/2 lbs. of lead and is designed to pour larger cavity molds. The 1911 has a 2-1/2" diameter cup to hold up to 1 1/4 lbs. of lead. The 1911 has a shorter handle design for better agility and ease of pouring. Both models feature left and right pouring lips and are intended for use with the 1904 cast iron pot.

### Hot Pot - 2

Item # 1892  
\$48.95

### Hot Pot - 2 Replacement Coils

Item # coil-2  
\$19.95



This is an improved version of the traditional "electric ladle." The heating element is now mounted externally to greatly extend element life. The HOT POT - 2 both melts and pours lead. Features: 3" X 13/4", 4 lb. lead capacity cast iron pot, heat resistant plastic hand stand, and three foot cord. 120 Volts AC, 500 Watts, by Palmer Mfg., Inc.

### Lee Lead Ladle

Item # 90026      \$7.29

Small sized ladle for use with Lee Precision Melter. Wooden handle, both right and left pouring lips are featured. Holds approx. 2 oz. of lead.



### Lee Production Pot IV

Item # 1901  
(110 Volt AC)-  
\$79.95

An efficient bottom pouring furnace that holds approximately 10 lbs. of lead. Features 4 inches of clearance under the spout. It is very good at making jigs weighing less than 1/2 oz. and can be used to mold sinkers up to one oz. in size. 500 watts, 110 V, adjustable heat control, and guaranteed by the manufacturer, LEE PRECISION, for two years.



### Lee Ingot Mold

Item # 90029      \$16.99

This four cavity aluminum ingot mold makes two each 1/2-pound and one-pound ingots. Includes a wooden handle.

### Lee Pro 4-20, 20 Lb. Electric Bottom Pour Lead Melter

Item # 1894  
(110 Volt AC)  
\$89.95

An affordable large capacity melter that holds 20 lbs. of lead in a 4X4 carbon steel pot. Features 4" of clearance beneath the spout, a new micro adjustable flow control valve, and an adjustable mold guide. It uses the patented Lee high-efficiency design with a dependable remote sensing thermostat. The flow valve can be adjusted to pour sinkers of up to 2 and 3 ounces quickly and without wrinkles.



### Lee Magnum Melter, 20 LB

Item # 1890  
\$72.95

Ladle pouring can be faster and better than bottom pouring for sinker molds, as well as some jig lure molds. At last there is an economical high capacity dip out melter available - the 20 lb. capacity LEE MAGNUM MELTER.

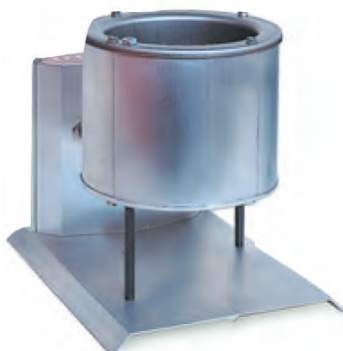

To Order: [www.grizzlyjig.com](http://www.grizzlyjig.com)

**A. Round Head Jig \$36.95**



The most popular all-around head style used in all waters of the United States, the Round Head Jig has probably taken more quantity and variety of fish than any other lure. In addition to being a good casting jig and a fairly rapid sinker, round head Jigs are among the easiest to tie.

**B. Round Head Jig- Staggered Barb Collar \$36.95**



A popular lure for pan fisherman. This double-barb collar style is designed to tightly secure the small 1.5" and 2" hollow plastic tube skirts. The upper barb is short, wide and blunt to hold the small hollow skirts tightly to the head or to add gripping power to solid soft plastic tails.

**C. Tube Skirt Jig \$36.95**



Just slip these jig heads inside hollow plastic tube skirts and go fishing. No painting or finishing necessary. Tube skirt jigs are designed for a friction fit inside the designated skirt sizes.

**D. Tapered Tube Skirt Jig \$36.95**



This style jig head is designed for speed loading into hollow plastic tubular jig skirts. Speed loading permits skirt collar changes without untying the jig from the line. These lures are easy to make and require no painting or finishing work.

**E. Crappie Jig \$36.95**



The horizontal, semi-flat shape helps the crappie jig fall slower and flutter more than most other jigs, so it's also successful for other panfish.

**F. Round Head Jig - Tapered Reverse Barb Collar \$36.95**



Tapered Reverse Barb Collar - Barbs are wider and not as sharp as the traditional "spike" barbs. Same holding power in SOLID soft plastic bodies, but much less likely to tear.

**G. Round Head Jig - Tapered Barb Collar \$36.95**



Tapered Barb Collar - Barbs are wider and not as sharp as the traditional "spike" barbs. Same holding power in SOLID soft plastic bodies, but much less likely to tear.

**H. Strap Decoy Anchor- Ingot Mold \$19.95**



This one-piece, three-cavity mold makes either strap type duck decoy anchors or lead ingots. There are two different levels of fill in each cavity. A melter and a ladle with capacity to hold a minimum six ounces of lead are required. This mold is not intended to be used with bottom pour furnaces.

**I. & J. Decoy Anchor Weights \$36.95**



These anchor weights have been an old standard of duck hunters everywhere for years. The mushroom shape is best in soft bottom areas. The pyramid shape is favored in hard bottom locations where it has less tendency to roll with a current.

Item #	Collar	Cavities	Ounces
A-1001	Ball	7	1/32, 1/16, 1/8, 1/4, 5/16, 3/8, 1/2
1002	Ball	8 (4/sz)	1/32, 1/16
1003	Ball	8 (4/sz)	1/8, 1/4
1004	Ball	6 (3/sz)	3/8, 1/2
1015	None	6	1/80, 1/64, 1/32, 1/16, 1/8, 1/4
1016	None	8 (4/sz)	1/32, 1/16
1017	None	7 (4-3/sz)	1/8, 1/4
1061	Ball	8 (4/sz)	1/16, 1/8
1062	None	8 (4/sz)	1/16, 1/8
B-3351	Staggered Barb	8 (4/sz)	1/32, 1/16
3352	Staggered Barb	8 (4/sz)	3/32, 3/16
3353	Staggered Barb	8 (4/sz)	1/8, 1/4
C-3070	None	8 (4/sz)	1/32, 1/16
3071	None	6 (2/sz)	1/8, 1/4, 3/8
D-3217	None	8 (4/sz)	1/32, 1/16
3364	None	6	1/8
3232	None	8	1/32
3233	None	8	1/16
E-3327	None	6 (3/sz)	1/32, 1/16
F-3119	Tapered Rev Barb	6	1/80, 1/64, 1/32, 1/16, 1/8, 1/4
3120	Tapered Rev Barb	6	1/8, 1/4, 3/8, 1/2, 3/4, 1
3121	Tapered Rev Barb	10 (5/sz)	1/64, 1/32
3108	Tapered Rev Barb	5	3/4
3109	Tapered Rev Barb	5	1

**K. Wrap-Around Decoy Anchor \$36.95**



This is the answer to the problem of moving decoys between different depths of water. Line is wrapped around the body of the anchor. It can be easily set for any depth by tightly wrapping the line off around one of the ears. A weight of this type eliminates retying the line during a change in water depths.

**L. Snag Weight \$36.95**

A weighted treble hook, or a Snag Weight, is used to retrieve objects from the bottom. Where legal, it is also used to catch fish by snagging. The weight directly on the hook provides good casting characteristics and holds your line in the water. Check local fishing regulations for legality.



Item #	Collar	Cavities	Ounces
G-1019	Tapered Barb	7	1/32, 1/16, 1/8, 1/4, 5/16, 3/8, 1/2
1020	Tapered Barb	8 (4/sz)	1/32, 1/16
1060	Tapered Barb	8 (4/sz)	1/16, 1/8
3350	Tapered Barb	6 (3/sz)	1/16, 1/8
1021	Tapered Barb	8 (4/sz)	1/8, 1/4
1022	Tapered Barb	6 (3/sz)	3/8, 1/2
3101	Tapered Barb	8	1/32
3102	Tapered Barb	8	1/16
3116	Tapered Barb	8	3/32
3103	Tapered Barb	8	1/8
3117	Tapered Barb	8	3/16
3104	Tapered Barb	7	1/4
3118	Tapered Barb	6	5/16
3105	Tapered Barb	6	3/8
3106	Tapered Barb	6	1/2
3107	Tapered Barb	6	5/8
H-1885	N/A	3	6-16
I-1198	N/A	2	8
J-1199	N/A	2	6
K-1154	N/A	1	7
L-1145	N/A	4	1/2 (2/0 SNAG)
1146	N/A	3	1 (4/0)
1147	N/A	3	1-1/4 (6/0)
1148	N/A	2	1-1/2 (8/0 SNAG)
1149	N/A	2	2-1/2 (10/0)
1156	N/A	3	1 (5/0 SNAG)



**M. Removable**

**Split Shot \$38.95**

This Split Shot has “teeth”, so you can crimp the sinker on your line or pinch the “ears” to remove it. Use pure or soft lead to mold these.

**N. Split Shot \$38.95**

The round Split Shot is one of this country’s most used sinkers because of the ease in which it can be attached to the line.

**O. Bass Casting-Swivel Bell Sinker \$36.95**

Bass Casting or Swivel Bell sinkers feature a molded-in swivel, so you don’t become the frustrated “twisted” fisherman.

**P. No Snag Sinker \$36.95**



Thin and flat, No Snag Sinkers derive their name from their tendency to rise above the bottom and glide over snags when retrieved.

**Q. River Sinker \$36.95**



These large donut-shaped sinkers hold their own against the currents in rivers, tidal flats, coastal areas and surf. The low profile and raised outer edges of the River Sinker prevent the rolling or tumbling that you’d expect under these conditions.

**R. No Roll Sinker \$38.95**



The flat, low profile does not drift with the current, so your line stays in place. A CP332 Core Pin for each cavity is included.

Item #	Insert	Cavities	Ounces
M-3170	None	15	1/4, 3/8
3171	None	20	1/16, 1/8
3172	None	20	1/32, 1/16, 3/32, 1/8
N-1127	B-40 Blade	20 (11-9/sz)	1/16, 1/8
1128	B-40 Blade	15 (8-7/sz)	1/4, 1/3
O-1110	No. 7 Barrel Swivel	8	1/8, 1/4, 3/8, 1/2, 5/8, 1, 1-1/2, 2
1112	No. 7 Barrel Swivel	9 (5-4/sz)	3/8, 5/8
1113	No. 7 Barrel Swivel	8 (4/sz)	1, 1-1/2
3256	No. 7 Barrel Swivel	9	1/2
3257	No. 7 Barrel Swivel	9	3/4
3258	No. 7 Barrel Swivel	9	1
3259	No. 3 Barrel Swivel	3	3, 4, 5
3260	No. 3 Barrel Swivel	2	6, 8
3261	1/0 Barrel Swivel	2	10, 12
3314	No. 7 Barrel Swivel	5	2
P-1123	N/A	5	3/8, 1/2, 5/8, 7/8, 1
1124	N/A	3	1, 1-1/2, 2
3343	N/A	2	3, 4
Q-3179	#2 Brass Wire Eye	3	2, 3, 4
3180	#2 Brass Wire Eye	2	5, 6
3276	#1 Brass Wire Eye	6 (3/sz)	1, 1-1/2
R-3244	CP332 Core Pin	4	1, 1-1/2, 2, 3
3385	CP332 Core Pin	3	3, 4, 5
3386	CP332 Core Pin	2	6, 8

**S. Pinch-On Sinker \$38.95**



Pinch-On Sinkers are very easy to attach and remove from the line. The ears of the sinker are simply folded over the line, which gives this sinker a streamlined shape when attached. It is important to use only soft lead when casting Pinch-On Sinkers.

**T. Bank Sinker \$36.95**



Bank Sinkers are one of the most popular sinker designs and enjoy great popularity with both fresh and saltwater fishermen. Bank Sinkers feature hexagon sides to resist rolling in current and a tapered shape for fewer snags in rocks.

**U. Bell Sinker \$36.95**

Bell Sinkers are teardrop shaped to cast smoothly and resist snags on the retrieve. Designed with a molded eye, these beauties can be produced quickly and inexpensively.



**V. Flat Bank Sinker \$36.95**



The Flat Bank Sinker gives you an edge in thick cover and fast waters. The low profile stays the course when other sinker styles might be pushed or rolled.

**W. Egg-Slip Sinker \$38.95**



The Egg Sinker, or Slip Sinker (as it is sometimes called), has numerous advantages over conventional sinkers. The line will slip through the sinker, thus the fish will not feel the weight of the sinker when it picks up the bait. Setting the hook will be quicker without the sinker’s resistance. In addition, the fish cannot use the sinker’s weight to help throw the hook when breaking water.

**Blank Mold For Custom Designs**

**\$39.95**

4 5/8" long X 2 1/8" wide

Item #	Insert	Cavities	Ounces
S-1126	B-40 Blade	7	1/16, 3/32, 1/8, 3/16, 3/8, 1/2, 5/8
3313	B-40 Blade	4	3/4, 1, 1-1/4, 1-1/2
T-1101	N/A	8	1/8, 1/4, 3/8, 1/2, 3/4, 7/8, 1, 1-1/2
1102	N/A	4	2, 3, 4, 5
1103	N/A	2	6, 8
1105	N/A	6	1
1106	N/A	4	2
1107	N/A	4	3
1108	N/A	3	4
1109	N/A	3	5
1165	N/A	1	10
1166	N/A	1	12
1167	N/A	1	16
1191	N/A	9	3/8
1192	N/A	8	1/2
1193	N/A	7	3/4
1194	N/A	6	1-1/2
3173	N/A	4	2-1/2
U-1114	N/A	8	1/8, 1/4, 3/8, 1/2, 5/8, 1, 1-1/2, 2
1116	N/A	9 (4-5/sz)	3/8, 5/8
1117	N/A	8 (4/sz)	1, 1-1/2
V-3356	N/A	3	3, 4, 5
3357	N/A	2	6, 8
3379	N/A	5	1/2, 3/4, 1, 1-1/2, 2
W-1121	PEG-332 Pull Pin	9 (5-4/sz)	3/8, 3/4
1122	PEG-332 Pull Pin	6 (3/sz)	1, 1-1/2
1170	PEG-332 Pull Pin	9	1/8, 1/4, 3/8, 1/2, 3/4, 1, 1-1/2, 2, 3
1171	PEG-332 Pull Pin	14 (7/sz)	1/8, 1/4
1172	PEG-332 Pull Pin	11 (6-5/sz)	1/4, 1/2
1173	PEG-332 Pull Pin	5	1, 2, 3, 4, 5
1174	PEG-332 Pull Pin	2	6, 8
3252	PEG-332 Pull Pin	3	2
3253	PEG-332 Pull Pin	3	3
3254	PEG-332 Pull Pin	3	4



**X. Horse Head Jigs \$36.95**

**Y. Pony Head Jigs \$36.95**

The lure's head, with its long and drooping nose, resembles a horse's head, hence the name. And it doesn't hurt that the shape looks like a larva to the fish. The slim shape of the jig's head design minimizes the chance of snags in rocks and brush, yet maximizes the flow of water around the lure to turn the spinner blade.



**Z. Sea Horse Jigs \$36.95**

A larger version of the Horse Head Jig, the Sea Horse uses the strong hooks you need to land Striped Bass and other large game fish. The bent down portion of the head serves as both an attachment point for the spinner blade and a stabilizing rudder to keep the torque of the rotating blade from turning this jig to its side.

**AA. Minnow Head Jig \$36.95**

This slim tapered head and protruding eyes give the Minnow head Jig its special appearance. Ideal for use with small shad bodies and other plastics, the Minnow Head Jig is as productive as it is attractive.



**BB. Bullet Jig \$36.95**

The Bullet Jig is a center balance jig with a tapered head. It smoothly shoots through the water attracting a variety of fish species.



**CC. Shad Dart Jig \$36.95**

A slant-faced, tapered jig that's named for migrating mid-Atlantic shad. The slanted head gives it a rising, "darting" action when the rod tip is raised.



**DD. Larva Jig \$36.95**

Fish love to dine on the harmless developing larva, so this jig is designed to mimic its falling action. The forward position of the hook eye makes the Larva Jig more snag resistant, even when ice fishing. Outfit with feathers or plastic tubular jig skirts to lure crappie and panfish.



**EE. Weedless Ball Jig - Fiberguard \$36.95**

The Weedless Ball Jig is designed to accept fiberguard weed and brush guards. Weedless Ball Jigs enable fishermen to spend more time fishing brush piles and weedbeds instead of freeing snags. Please Note: These models will not accept Y-Guards or base hole pins.



**FF. Canon Ball Sinker \$36.95**

Canon Balls drop faster and straighter than other sinkers. Load your rig with these round sinkers and shoot your lure down to the depths you need.



Item #	Insert	Collar	Cavities	Ounces
X-1220	#12 Crane Swivel	None	6	1/48, 1/32, 1/16, 1/8, 3/16, 1/4
1221	#12 Crane Swivel	None	8 (4/sz)	1/32, 1/16
Y-1224	#12 Crane Swivel	Barb	5	1/32, 1/16, 1/8, 1/4, 3/8
3201	#12 Crane Swivel	Barb	6	1/16
3202	#12 Crane Swivel	Barb	5	1/8
3203	#12 Crane Swivel	Barb	5	1/4
Z-1227	#10 Crane Swivel	Ring & Barb	4	1/4, 3/8, 1/2, 5/8
1228	#7 Crane Swivel	Ring & Barb	3	3/4, 1, 1-1/2
AA-1084	N/A	Barb	7	1/48, 1/32, 1/16, 1/8, 3/16, 1/4, 3/8
1085	N/A	Barb	8 (4/sz)	1/32, 1/16
1086	N/A	Barb	7 (4-3/sz)	1/8, 1/4
3421	N/A	Barb	7	1/48, 1/32, 1/16, 1/8, 3/16, 1/4, 3/8
3422	N/A	Barb	8 (4/sz)	1/32, 1/16
BB-1059	N/A	Barb	7	1/8, 1/4
3361	N/A	Barb	8 (4/sz)	1/32, 1/16
CC-3031	N/A	None	7	1/32, 1/16, 1/8, 1/4, 3/8, 1/2, 3/4
3032	N/A	None	8 (4/sz)	1/64, 1/32
3360	N/A	None	8 (4/sz)	1/16, 1/8
DD-3216	N/A	1-1/2" Small Dia.	8 (2/sz)	1/32, 1/16, 3/32, 1/8
EE-3241	FG-9	Reverse Barb	6	1/32, 1/16
3317	FG-9	Reverse Barb	5	1/32, 1/16, 1/8, 1/4, 3/8
FF-3184	#1 Brass Wire Eye	N/A	10 (5/sz)	1/2, 3/4
3185	#1 Brass Wire Eye	N/A	4	1, 2, 3, 4
3186	#2 Brass Wire Eye	N/A	3	4, 5, 6
3187	#2 Brass Wire Eye	N/A	2	8, 10
3188	#2 Brass Wire Eye	N/A	2	12, 16

**Brass Barrel Swivels**  
for 2 oz. and down

**SPECIAL**  
10 GROSS #7  
\$46.95

**Bulk Barrel Swivel**  
for Bass Cast Sinkers

**Runner Head Components**

**BARRELSWIVELS-BRASS**

Made in KOREA

SIZE	CT	PRICE
12	1 GROSS (144)	7.99
7	1 GROSS (144)	7.99

**CRANESWIVELS-Nickel**

SIZE	CT	PRICE
12	1 GROSS (144)	7.95

**SPLIT RINGS-SS**

SIZE	CT	PRICE
0	100	2.69
1	100	2.89

**COLORADO BLADES**

SIZE	CT	PRICE
00	100	4.95
0	100	5.50
1	100	5.95

**Size 0 Nickel Willow Leaf**



**\$6.99 per 100 ct BRASS**  
**\$7.99 per 100 ct**

# Catfish Corner

#TL-MRTD20



\$9.99

### Muddy River's Best Trotline

100' Twisted Nylon  
20 1' Drops Doubled  
20 5/0 Steel Hooks  
20 #1 Barrel Swivels  
*Swivels tied to Mainline*

### Eagle Claw Trotline

W/25 049Z-3/0 Hooks

#ATROT100



\$10.99

100' Nylon

### Eagle Claw Black Floating Trotline

W/25 049Z-3/0 HOOKS  
#ATROT120F

\$12.95



120' Black Nylon

### Heavy Duty Poly Stringers



HDS-7' .....\$1.69  
HDS-9' .....\$1.79  
HDS-12' .....\$1.99  
HDS-25' .....\$2.99

### MAYBRUN'S Commercial Catfish Skinner



Regular #03103 \$8.95  
Stainless #03104 \$12.95

### JACKSON PRO SKINNER



#2100

#1003 COMMERCIAL FISHERMAN'S PINCHER For those who skin fish commercially. Heavy duty stainless steel spring with sure grip handle grips to prevent slipping.

USA  
\$7.99

Made by a Mississippi Catfish Farmer

#FAFS-S,M,L,XL

### NO-KNOT fas-snap

Use with Hooks & Lures  
Made of Spring Steel for Strength!



Small  
Medium  
Large  
X-Large  
99¢ 3 pk

### FLY LINE EYELETS

#FA-PB300

FITS L - 6 - 7 - 8 - 9 LINES  
2 PK  
99¢



Eliminates Bulky Knots For Level Line

### Stake Rod Holder

This rod holder is made of heavy steel and has a black, baked-on enamel finish. The rod holder is fully adjustable at the top. The stake is 14" in length without the top attached. Each rod holder is polybagged with a header card.

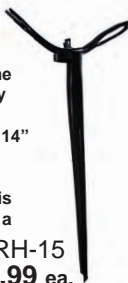

SRH-15  
\$2.99 ea.

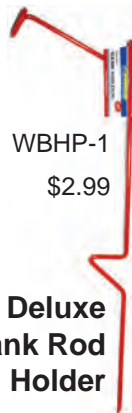

WBHP-1  
\$2.99

Deluxe Bank Rod Holder

### CATFISH RIG Double Drop Spreader Arm Bottom Rig

Made with 60 lbs. test, nylon coated, multi-strand stainless steel wire, this 19" surf and pier rig is constructed with two 2-3/4" free-turning steel wire spreader arms which allow bait movement! Assembled with red fluorescent beads, barrel swivel for mainline hookup and an interlock snap for sinker attachment.



#1040-WHO

CR-1.....\$.79 Each  
CR-DZ.....\$7.95 DZ  
CR-50.....\$25.95 50 pk

Monofilament 60# Rig Available  
#1060-HD

### Lake & Stream Quality Clear Fishing Line



\$2.25 ea

ITEM #	YARDS	TEST
09011-004	900	4 lb.
09011-006	800	6 lb.
09011-008	670	8 lb.
09011-010	500	10 lb.
09011-012	400	12 lb.
09011-015	300	15 lb.
09011-020	275	20 lb.
09011-025	225	25 lb.
09011-030	200	30 lb.
09011-040	150	40 lb.
09011-050	120	50 lb.
09011-060	90	60 lb.
09011-080	60	80 lb.

### 9 SNAP CHAIN STRINGER



CS-946 46" \$2.99 ea  
CS-960 60"

\$3.99  
Bag

# MAGIC BAIT

## Americas Favorite CATFISH BAIT

\$39.95  
CS-12 Bags

CATFISH



- KING KAT**  
Chicken BL.
- OLE WHISKERS**  
Beef BL.
- GREAT SCOTT**  
Cheese
- WHOPPER**  
Shad.
- CRAWFISH**  
w/ Chicken Bld.
- SHRIMP**  
w/ Chicken Bld.

**Magic Bait Bait Dipper**

**Magic Bait Dough Bait Hooks w/ Sponge #4**

**Magic Bait Big'N Bait Holder**



\$1.49  
3 pk  
ITEM #  
MB-SG21



\$2.49  
2 pk  
ITEM #  
MB-BNG  
MB-BNR  
COLOR  
Green  
Red

\$2.49  
2 pk

ITEM #  
CB-MB-G33 Green  
CB-MB-R23 Red  
CB-MB-Y55 Yellow

**Trotline Clips**  
25 pk \$9.99



\$2.49  
2 pk

ITEM #  
MB-G37 Green  
MB-R59 Red  
MB-Y34 Yellow  
MB-P38 Purple

**Magic Bait Bait Holder**



**DOC'S SUPER CATFISH WORMS**

- DCW-Red DCW-White
- DCW-Yellow DCW-Purple
- DCW-Black DCW-Orange
- DCW-Natural DCW-Chart



\$1.99  
2 pk

\$19.99  
DZ-2 pk



**Brass Brads**  
50 pk \$4.69  
03261-50

### Sonny's Super Sticky Channel Cat Bait

Exact same bait we have been selling for 20 years!  
If it doesn't sat Hootman Brothers, it is not Sonny's

SCB-20  
Regular Cheese

SCB-20B  
Regular Blood

\$99.95

20# Bucket  
(3.5 gallons)



45 oz.  
Tub  
\$19.95



SCB-45  
Regular Cheese

SCB-45B  
Regular Blood

\$69.95  
Case/4 Tubs

SCB-CS-4  
Regular Cheese

SCB-CS-4B  
Regular Blood



To Order: 1-800-305-9866

# BAKER®

## Precision Fishing Tools

**Digital Scale**  
30 lb/13.6 kg

#B-ES30  
**\$20.99**



- LED Redout w/ Back Lighting
- Memory Mode Stores up to 10 Weight Readings
- Auto Shut Off
- Scale Requires 2 AAA Batteries (Not Included)

**Dual Knife Sharpener**

#BDKS

**\$6.49**

- 2 grooves ceramic/carbide
- Hook hood
- Wrap around hand guard



### Hookout - "T" Style

- Just squeeze and twist



2 SIZES

#B-HM Mini 4" **\$ 8.99**  
#B-HT Maxi 13" **\$15.95**

### Fisherman's Forceps Stainless Steel



#BFF35 3 1/2" Straight **\$3.99**  
#BFF55 5 1/2" Straight **\$4.49**

### 8" Curved Fisherman's SS Forceps



#BFF8  
**\$5.99**

### Brush'n Boat Anchor It's a real grabber!

- Locks onto limbs, brush, and docks



#BH9  
**\$3.99**

### Mouth-Spreader

Great for toothy game fish!



2 SIZES

#MS6 6" **\$1.99**  
#MS8 8" **\$2.99**

### Baker Value Combo

- Curved Forceps
- Retractor
- Line Nipper & Jig Eye Punch



#BLLFRN  
**\$7.99**

### BETTS Billy Ray GRAB 'N' GRIP

#FG-9  
**\$9.99**

- Hi-Vis
- Floats
- W/ Lanyard
- Easy One Hand Operation



### Eagle Claw Bait Rigs

#L948-2  
**\$2.49**

- 51" 12# Line
- 5...1-1/2" Pearl Shrimp
- #2 Hooks

Our #1 selling skipjack rig!



### GRIZCO Sinker Slide



GR-SS-6CT **\$1.99**  
GR-SS-24CT **\$5.79**

#08012-014

### Eagle Claw Heavy Duty Wire Leader



**\$2.29**  
3 PK

18"  
60#

### HT Bead Assortment

100 pc

#ASB-100



**\$2.49**





**WOMEN'S PRO ACTION RAINSUIT**

Black Cherry Jacket

AVAILABLE IN S, M, L, 2XL

Item	Price
PA63523-15__ SIZE	\$29.95

Black Pants

AVAILABLE IN S, M, L, 2XL

Item	Price
PA63522-01__ SIZE	\$19.95



Item	Size	Price
PA93109-01S	Small	\$26.95
PA93109-01M	Medium	\$26.95
PA93109-01L	Large	\$26.95
PA93109-01XL	X-Large	\$26.95
PA93109-012X	2X-Large	\$26.95
PA93109-013X	3X-Large	\$28.95



**MEN'S PRO ACTION RAINSUIT**

KHAKI JACKET

AVAILABLE IN S, M, L, XL, 2XL

Item	Price
PA63123-04__ SIZE	\$29.95

ROYAL BLUE JACKET

AVAILABLE IN S, M, L, XL, 2XL, 3XL

Item	Price
PA63123-12__ SIZE	S-2X \$29.95 3X \$31.95



**REALTREE MAX-5 JACKET**

AVAILABLE IN S, M, L, XL, 2XL, 3XL

Item	Price
PA63123-56__ SIZE	S-2X \$39.95 3X \$42.95



**REALTREE MAX-5 PANTS**

AVAILABLE IN S, M, L, XL, 2XL, 3XL

Item	Price
PA83102-58__ SIZE	S-2X \$32.95 3X \$34.95



*The undisputed leader  
in lightweight,  
breathable, affordable  
rainwear.*

**BLACK PANTS**

AVAILABLE IN S, M, L, XL, 2XL, 3XL

Item	Price
PA83122-01__ SIZE	S-2X \$19.95 3X \$21.95

To Order: 1-800-305-9866



# Grizzly Jig T-Shirts

Grizzly's Logo T-Shirt

Grizzly Jig Co. T-Shirt

Youth Crappie Attitude T-Shirt



\$10.95

Size M Pictured

#YCA-Gray  
Youth XS-S-M-L



Back

- # GB-Dark Heather
- # GB-Military Green
- # GB-Serene Green
- # GB-Dark Heather w/ Hot Pink Grizzly
- # GB-Burgundy
- # GB-Orange
- # GB-Black

M-L-XL-2X

Adult Tees  
\$12.95 ea



Front



Front

- # GJC-Charcoal
- # GJC-Red
- # GJC-Paprika
- # GJC-Chesnut
- # GJC-Neon Yellow
- # GJC-Orange
- # GJC-Heather Red

M-L-XL-2X

Adult Tees  
\$12.95 ea

S-M-L-XL-2X



- # CA-Gray
- # CA-Gold
- # CA-Tan

Grizzly's Crappie Attitude T-Shirt



# CA-Hot Pink

# CA-Neon Yellow/Pink

# CA-Forest Green

Grizzly Jig Sport Tek®

Long Sleeve Tees

#GJST - S - M - L - XL - 2X



\$19.99

- |             |            |          |
|-------------|------------|----------|
| Gray        | Orange     | Red      |
| White       | Neon Green | Gold     |
| Atomic Blue | Tan        | Burgundy |

Stay dry with Sport-Tek®

Loose Fit

## Grizzly Jig Custom Hoodies



#GJCH-\_\_\_-COLOR  
SIZE

\$29.95

- |       |                   |            |              |      |
|-------|-------------------|------------|--------------|------|
| Black | Dark Heather Gray | Lt. Pink   | Red          | Kiwi |
| Navy  | Forest Green      | Dark Brown | Safety Green | Sand |
|       |                   |            |              | Gold |

To Order: [www.grizzlyjig.com](http://www.grizzlyjig.com)

# B'n'M sportswear

## BLACK OR RED LONG-SLEEVE TEES

All-Black, Gildan 100% Ultra-Cotton long-sleeve Tee Shirt with B'n'M Splash Logo on breast and across the back. Comfortable to wear, good-looking, and easy to care for. Wear your B'n'M Colors with pride! SIZES: M, L, XL, 2XL, 3XL

ITEM: BLACK-LS-TEE \$19.99 ea  
RED-LS-TEE



## VINTAGE BROOMS & MOPS HAT

A throw back to our founding in 1947 when we began as a Broom and Mop company. Shortly thereafter we got into the bamboo cane pole business, but the name stuck. This mesh back hat will keep you cool and looking great!

ITEM: C10 \$15.95



## NEON MESH HATS



Orange/Black ITEM C8  
Green/Gray ITEM C9 \$15.95  
Green/Black ITEM C6  
Blue/Black ITEM C7

## BROWN SLICK-OILED HAT

Our Slick-Oiled cap looks and feels like a great old friend. Beautifully weathered and distressed, this sturdy cap has the character of a vintage bomber jacket - the real deal. One size fits all, but especially good for larger sizes!

ITEM: C5  
\$14.95



## COOL-MESH HAT \$14.95

Cool Is The Rule!  
Now you can display your favorite logo in cool-mesh comfort. One size fits all.  
Olive and Khaki combo.  
ITEM: C3



## LOW-CROWN HATS

Low-Crown, Unstructured 6-panel Baseball-Style cap. Khaki or Olive Green, one size fits all with buckle adjustment.  
Khaki Cap ITEM: C1 Olive Cap ITEM: C2  
NEW PINK! ITEM: C4

\$14.95

## SUNVISORS

Adjustable, one-size-fits-all construction, and machine washable. Cool!  
ITEM: SVCAMO, SVBLAZE, SVRED

\$16.95



To Order: 1-800-305-9866

# Boyette's Resort

## On Beautiful Reelfoot Lake Tennessee



**STAY FOR ONE DAY OR A MONTH!**  
 We guarantee your stay to be relaxing and enjoyable... You are not a customer, you are a friend!



Cottages with kitchenette, Cable TV, Telephone, Pool, Licenses & More!

Come and visit the "Quake Lake"...Scenic Reelfoot!  
 Crappie, Bass, Catfish, Bluegill, Ducks, Geese, Eagle Watching...**WE HAVE IT ALL!**

Call Toll Free: 888-465-6523  
 or 731-253-6523

[www.lakereelfoot.net](http://www.lakereelfoot.net)  
[boyettesresort@lakereelfoot.net](mailto:boyettesresort@lakereelfoot.net)



Come as a guest,  
 leave as a friend!

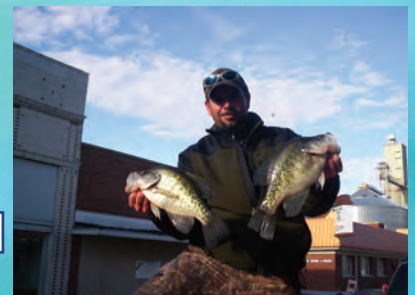

		<p><b>MC-001</b></p> <p>Khaki/Red Trim</p>	<p><b>MC-002A</b></p> <p>Bright Green/Black</p>
		<p><b>MC-003</b></p> <p>Camo</p>	<p><b>MC-006</b></p> <p>Red/Mesh</p>

All Hats  
 \$15.95

**MR. CRAPPIE**



**NEW! MC-WHITE-SS  
NEW! MC-WHITE-LS  
SS-\$14.95 LS-\$19.95**



**SIZE MED-3X  
(ADD \$2 FOR 2X & 3X)**

**NEW! MC-ORANGE-SS  
NEW! MC-ORANGE-LS  
SS-\$14.95 LS-\$19.95**



**SIZE MED-3X  
(ADD \$2 FOR 2X & 3X)**

**MC-SG-SS  
\$14.95**



Sports Grey

**SIZE MED-3X  
(ADD \$2 FOR 2X & 3X)**

**MC-RTG  
\$14.95**



**SIZE MED-3X  
(ADD \$2 FOR 2X & 3X)**

**MC-COMFORT  
\$14.95**



**SIZE MED-2X  
(ADD \$2 FOR 2X)**

**MC-GOLD-LS  
MC-BLACK-LS  
\$19.95**



**SIZE MED-3X  
(ADD \$2 FOR 2X & 3X)**

**MC-JR  
\$12.95**



**SIZE YOUTH S-M-L**

**MS-PINK  
\$12.95**



**SIZE YOUTH S-M-L**

**YMC-HI-VIZ-CHART  
YMC-HI-VIZ-ORANGE  
\$12.95**



**SIZE YOUTH S-M-L**

**MS-HBH-MINT  
MS-HBH-HOTP  
MS-HBH-VIOLET  
\$14.95**



**SIZE SMALL-2X  
(ADD \$2 FOR 2X)**

**MS-HBH-LS-WHITE  
MS-HBH-LS-VIOLET  
MS-HBH-LS-HOTP  
\$19.99**



**SIZE SMALL-2X  
(ADD \$2 FOR 2X)**

# B'n'M ProStaff DVD library

## Anytime, Anyplace, Any Water

# Crappie!

**Pro-Staff Training DVDS** These spectacular Teaching DVDS (really, they are) utilize tutorials, diagrams, and on-the-water footage to educate the casual fisherman about the newest (and oldest) techniques of catching crappie in any condition. Covering many different techniques, these DVD's are professionally produced and edited by Russ Bailey, host of the popular TV show "Brush Pile Fishing".

Each segment includes diagrams, how to, and (3) tips for each technique, and each segment is conducted with a different Pro-Staffer from B'n'M. They cover a wide variety of products and manufacturers, not just B'n'M. From vertical jigging to pulling summertime crankbaits, these DVDS will help you catch more crappie.

**No. 1:**

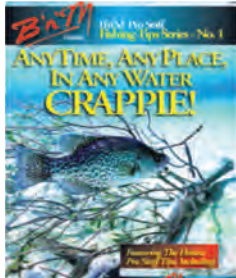

### Anytime, Anyplace, Any Water CRAPPIE NO. 1

Our first release broke ground by using tutorials, diagrams, and on-the-water footage to educate the casual fisherman about the newest (and oldest) techniques of catching crappie in any condition. Covering (9) different techniques, this DVD is professionally produced and edited by Russ Bailey, host of the popular TV show "Brush Pile Fishing". Each segment includes diagrams, how to, and (3) tips for each technique and each segment is conducted with a different pro staffer from B'n'M. It covers a wide variety of products and manufacturers, not just B'n'M. From vertical jigging to pulling summertime crankbaits, this DVD will help you catch more crappie.

ITEM: AC-1 \$12.95



**No. 2:**

### Anytime, Anyplace, Any Water CRAPPIE NO. 2

Folks said our first DVD was terrific, but "Number Two" has kicked it up a notch for sure. This instructional video series sets a whole new standard for Crappie Fishing, putting you in the seat with the best in the business - the BnM Pro Staff. Go fishing with Russ Bailey, Roger Gant, Kent Driscoll and host of other Pro Staffers as they use tutorials, diagrams, and on-the-water footage to teach you the newest (and oldest) techniques of catching crappie in any condition. "No. 2" covers 10 different techniques that they've mastered to find and catch crappie in any water, in any spot, in any time of year. Filled with great diagrams to illustrate every point, it's just like being in the boat with the best. This DVD reveals all the secrets the Pro's use to win tournaments!



ITEM: AC-2 \$12.95



**If you are planning a trip to Reelfoot Lake, this DVD is a must!**



**\$12.95**

- In-depth Equipment Review
- Pop-up Boxes for Special Tips
- Fishing Lily Pads, Trees & Shallow Water
- Reelfoot Lake Spring & Summer Fishing Tips
- Tactics for Any Lake or River that has Shallow Water

2 NEW MUST HAVE BOOKS BY AMERICA'S #1 CRAPPIE FISHING EXPERT - TIM HUFFMAN

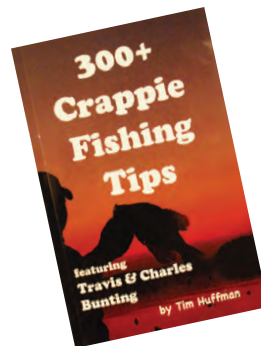

#HUFF-1

Your Choice \$12.95

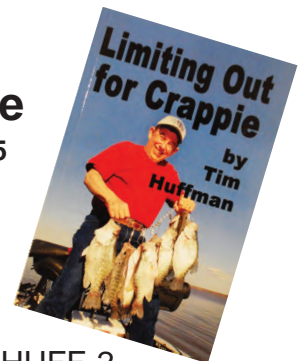

#HUFF-2

To Order: [www.grizzlyjig.com](http://www.grizzlyjig.com)

# Fishing Hot Spot Maps

\$9.99



We cover most of the lakes on the CrappieMasters, Crappie U.S.A. or A.C.T. Tournament Trails.

## MAPS CONTAIN

### •Boat Ramps

- Depth Contours
- Structure
- Fishing Info
- GPS Points

## ALABAMA

- L393 Eufaula (Walter F. George Reservoir)
- L336 Guntersville
- L338 Logan Martin Lake
- L337 Pickwick Lake
- L470 Weiss Lake
- L506 West Point Lake
- L471 Wheeler Lake
- L339 Wilson Lake

## ARKANSAS

- L173 Beaver Lake
- L171 Bull Shoals- East
- L172 Bull Shoals - West
- A119 Dardanelle
- L701 DeGray
- A121 Greens Ferry Lake
- A123 Millwood Lake
- L174 Norfolk Lake
- A124 Ouachita

## GEORGIA

- L392 Allatoona Lake
- L650 Clarks Hill Lake (J. Strom Thurmond Reservoir)

## ILLINOIS

- L393 Eufaula (Walter F. George Reservoir)
- L394 Hartwell - East
- L395 Hartwell - West
- L508 Oconee
- L649 Russell
- L390 Sidney Lanier - North
- L391 Sidney Lanier - South
- L507 Sinclair
- L506 West Point Lake

## MISSISSIPPI

- M365 Braidwood Lake
- L181 Carlyle Lake
- G184 Cedar Lake
- L182 Clinton Lake
- M361 Crab Orchard Lake
- G185 Devils Kitchen Lake
- L183 Fox Chain - North
- L184 Fox Chain - South
- G221 George Illinois
- M216 Heidecke Collins Lk
- M352 Illinois River (Starved Rock to Hennepin)
- M366 Kankakee River (IL/IN Line to Illinois River)

- L185 Kinkaid Lake
- M360 Lake of Egypt
- G186 Little Grassy Lake
- G212 Mill Creek Newmans Lake
- M265 Mississippi River - Pool 13
- L729 Mississippi River - Pool 21
- M358 Mississippi River - Pool 26
- G187 Otter Lake
- L186 Rend Lake
- M367 Rock River (Rockton to Oregon Dam)
- M357 Sangchris Lake
- M217 Shabbona Lake
- L187 Shelbyville
- G188 Springfield Lake

## KANSAS

- M384 Clinton Lake
- M385 Hillsdale Lake
- M388 Milford
- M389 Melverne
- M387 Perry Lake
- M390 Pomona

## KENTUCKY

- L112 Barkley - North
- L113 Barkley - South
- L441 Barren River Lake
- L442 Cave Run Lake
- L443 Cumberland - East
- L444 Cumberland - West
- L119 Dale Hollow Lake
- L445 Green River Lake
- L121 Kentucky Lake - Central
- L120 Kentucky Lake - North
- L111 Laurel River Lake
- L114 Nolin River Lake
- L115 Rough River Lake
- L110 Taylorsville Lake

## LOUISIANA

- A437 Toledo Bend - North
- A438 Toledo Bend - South

- MISSISSIPPI
- A267 Enid Lake
- A268 Grenada Lake
- A269 Ross Barnett Reservoir
- A270 Sardis Lake

## MISSOURI

- L171 Bull Shoals - East
- L172 Bull Shoals - West
- L160 Lake of the Ozarks - NE
- L159 Lake of the Ozarks - SE
- L158 Lake of the Ozarks - W
- L157 Mark Twain Lake
- L729 Mississippi River - Pool 21
- M358 Mississippi River - Pool 26

## LAKES

- L161 Pomme De Terre Lake
- L165 Smithville Lake
- L162 Stockton Lake
- L155 Table Rock Lake - East
- L156 Table Rock Lake - West
- L163 Truman Reservoir - North
- L164 Truman Reservoir - South
- L166 Wappapello

## NORTH CAROLINA

- A312 B. Everett Jordon Lake
- A313 Falls Lake
- A314 Gaston
- A315 High Rock Lake
- A463 Kerr Reservoir Buggs Island - East
- A464 Kerr Reservoir Buggs Island - West
- A316 Norman

- AL850 Wylie
- NC0101 Long Bay (Sunset Beach to Cape Fear)
- NC0104 Cape Lookout (Bogue Sound to Drum Inlet Inshore)

## SOUTH CAROLINA

- L650 Clarks Hill Lake (J. Strom Thurmond Reservoir)
- L659 Greenwood
- L394 Hartwell - East
- L395 Hartwell - West
- L654 Marion (Santee Cooper)
- L656 Moultrie (Santee Cooper)
- L655 Murray
- L649 Russell
- AL850 Wylie

## TENNESSEE

- L112 Barkley - North
- L113 Barkey - South
- A400 Center Hill Lake
- A401 Cherokee Lake
- A402 Chickamauga
- L119 Dale Hollow Lake
- A404 Douglas Lake
- L736 Ft Loudon
- A408 J. Percy Priest Lake
- L121 Kentucky Lake - Central
- L120 Kentucky Lake - North
- A405 Nickajack Lake
- A406 Norris Lake
- A407 Old Hickory Lake
- A409 Reelfoot Lake
- L735 Tellico
- A410 Tlms Ford Lake
- A411 Watts Bar Lake

**WHOLESALE  
PRICING AVAILABLE.  
GIVE US A CALL!**

**To Order: 1-800-305-9866**

Model #FF1, #FF2, and #FF2-Super can be drop shipped for \$50 within the continental US. For Model #FF3, call for shipping price.



#FF1 Single Basket fryer - 2.5 gal. Caddy included. Basket Dimensions: 11" x 5-3/8" x 4-1/8" High quality basket design for easy, safe frying.

**\$339.95**

#FF2

Regular - 2 basket fryer - 4 gal. Roll around caddy included.

Basket Dimensions: 11" x 5-3/8" x 4-1/8" High quality basket design for easy, safe frying.

**\$399.95**

#FF2E Economy 4 Gal. FF2E comes with 4 leg stand. Does NOT include roll around cart.

**\$339.95**



Uses 70% less oil.

## The Original Cajun Fryer

*Fry like a pro every time.*

Made in the **USA**

Versatile, high performance, low maintenance propane gas fryers that are unsurpassed in quality. The oil stays clean and food is never scorched, **GUARANTEED!**

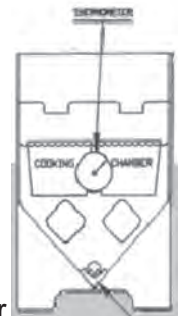

#FF2-Super Super - 2 basket fryer - 6 gal. Roll around caddy included. Basket Dimensions: 13-1/4" x 5-5/8" x 5-5/8"

High quality basket design for easy, safe frying.

**\$454.95**



#FF3 Regular - 3 basket fryer - 8 1/2 gal. Roll around caddy included.

Basket Dimensions: 13-1/4" x 5-5/8" x 5-5/8" High quality basket design for easy, safe frying. quality basket design for easy, safe frying.

**\$539.99**

Available in stainless steel. Special Order - [Drop Ship Only](#) Call For Quote



Shipping Quote Only!



FOR FRYING OR BAKING

**COATING BUDDY** **\$13.99**

FISH SHRIMP CHICKEN OYSTERS ONION RINGS FRENCH FRIES MUSHROOMS OKRA

"THE QUICK AND EASY WAY TO PREPARE PERFECTLY COATED FISH, SEAFOOD, MEATS, VEGETABLES AND WILD GAME"





# Grizzly Jig Company Order Form

303 Ward Ave, Caruthersville, MO 63830

**Order 1-800-305-9866**

Monday through Saturday

7:00 a.m. - 5:00 p.m.

Central Standard Time

**or from the Web**

www.grizzlyjig.com

Email: sales@grizzlyjig.com

Date \_\_\_\_\_

Name \_\_\_\_\_

Address \_\_\_\_\_ Apt. \_\_\_\_\_

City \_\_\_\_\_ State \_\_\_\_ Zip \_\_\_\_\_

Email Address \_\_\_\_\_

Daytime Phone (\_\_\_\_) \_\_\_\_\_

Find us on Facebook or  
follow us on Twitter!



Item Number	Quantity	Product Description	Price Each	Total Cost

Additional order form space on back.

Ship To:  
(If different than above.)  
Name \_\_\_\_\_  
Street Address  
(No P.O. Box)  
\_\_\_\_\_  
City \_\_\_\_\_  
State \_\_\_\_ Zip \_\_\_\_  
Phone \_\_\_\_\_

Please check type of payment:  
 Personal Check     VISA     DISCOVER  
 Money Order     MASTERCARD     AMERICAN EXPRESS  
 Expiration Date: \_\_\_\_ Month \_\_\_\_ Year  
 Credit Card Number \_\_\_\_\_  
 V-Code on Back, Last 3 Digits \_\_\_\_ \_ \_  
 Signature \_\_\_\_\_  
 Print Name \_\_\_\_\_  
**We also accept PayPal.**

Total this page	
Total from back	
<b>Subtotal</b>	
Sales Tax MO Res. ONLY Add 9.225%	
<b>Shipping</b>	
Additional Shipping for items over 84" or 40 lbs. (See back.)	
<b>Total \$\$ Enclosed</b>	

**SHIPPING**

Standard Shipping  
**\$0.01-\$50 : \$8.95**  
**\$50.01-\$75 : \$9.95**  
**\$75.01-\$100 : \$10.95**  
**\$100.01-\$125 : \$12.95**  
**\$125.01-\$200 : \$13.95**  
**Over \$200 : \$16.95**

Items over 84"  
 Length & Girth  
**Add \$6.00**

Items over 108"  
**or**  
 40 lbs.  
 (ex: pontoon furniture, etc.)  
**Call for quote.**

Specific Items Requiring  
 Additional Shipping  
 Boat Seats, Double Boat Seat Stands,  
 Ego Nets, Cases of Catfish Bait, One  
 Piece Rods over 6', Two Piece Rods  
 Over 12', Some Rod and Reel Combos  
 (2 Box), Over 40 Lbs. Bulk Sinkers

**Orders that require more than one  
 package will be charged  
 additional shipping.**  
**Includes rod and reel combos.**

If there is a problem with your order,  
 please notify us within 7 days.

**Shipping Information:**

1. UPS Ground or Post Office
2. If a package must be shipped by your choice of carriers, please call for shipping quote.
3. Next Day Air & 2nd Day Air available upon request. Call for price quote.
4. Rates apply to U.S. Continental 48 states.
5. Trolling motors-call for quote.
6. 10' or longer 2 piece rods shipped UPS add \$6.00.

**Shipping Subject to Change  
 Without Notice**

<b>Item Number</b>	<b>Quantity</b>	<b>Product Description</b>	<b>Price Each</b>	<b>Total Cost</b>
<b>Total Page Transfer to Front</b>				

To place an order call 1-800-305-9866  
 Monday through Saturday  
 7:00 a.m. - 5:00 p.m.  
 Central Standard Time  
 or from the Web [www.grizzlyjig.com](http://www.grizzlyjig.com)



The SOUNDTRACK of AMERICA  
• MADE IN •  
**TENNESSEE™**  
— ★ ★ ★ —



BEAUTIFUL  
*Reelfoot Lake, Tennessee*

**REELFOOT LAKE is one of the world's greatest natural fish hatcheries making it a favorite spot of America's Pro and recreational fishermen.**

REELFOOT LAKE is in the center of the Mississippi Flyway **making it a favorite destination for duck and goose hunting.**

REELFOOT LAKE features one of the largest populations of **American bald eagles outside of Alaska.**

REELFOOT LAKE appeals to photographers, bikers, hikers, kayakers, picnickers, campers, RVers and those who want to **enjoy a meal at one of our famous restaurants.**

For more information about Reelfoot Lake, resorts, guide **services and accommodations visit our website [www.reelfoottourism.com](http://www.reelfoottourism.com) or call 731-253-2007 for a Visitors Guide.**

Reelfoot Lake Tourism Council

**1605 State Route 21 E**

**Tiptonville, TN 38079**

**731-253-2007**

**[www.reelfoottourism.com](http://www.reelfoottourism.com)**

**[visit@reelfoottourism.com](mailto:visit@reelfoottourism.com)**



Grizzly Jig Company  
303 Ward Ave.  
Caruthersville, MO 63830

PRSRT STD  
U.S. POSTAGE  
PAID  
Grizzly Jig Company

To order:  
Call 1-800-305-9866

Open Monday - Saturday  
7:00 a.m. - 5:00 p.m. CST  
www.grizzlyjig.com

Where the pros shop!



**SPECIAL**  
Any 4 Rods  
**\$80.00**

Back by popular demand!

Slab Daddy  
Crappie  
Rods

- Graphite Composite Blank
- EVA Foam Handle
- Fixed Reel Seat

#SD \_\_ 8' \_\_ 9' \_\_ 10'

For more than 4 rods,  
add \$20.00 each.

**NEW SPECIAL**

#SD\_12' #SD\_14' 4 for \$100.00



**9' Cat Daddy Combo**

Sale Price  
**\$29.95**  
Regular Price  
**\$59.95**

- Rod
- 2 Pc Tubular Glass
  - Graphite Reel Seat
  - Double Footed Stainless Guides
  - Spinning Style

- Reel
- Size 70
  - 3 Ball Bearings
  - 32 Point Multistop Anti-Reverse
  - Prespooled w/ 20# Hi-Vis
  - 4.7:1 Ratio



**The History Maker**  
**33 Micro or Micro Trigger**

33MTK



33MCK

**\$14.95**

**While they last!**

- Right or Left Hand
- BB Drive
- All Metal Gears
- Bite Alert
- Stainless Steel Covers
- Spooled w/ 4# Mono



Heavy duty reel for heavy duty fish!  
**BIG CAT 350XT**

Special Price  
**\$39.95**



- 3 Bearing 2+1
- 200 yds/20#
- 6.3:1 Ratio
- Aluminum Frame
- Continuous Anti-Reverse
- Right Hand Retrieve

We bought these reels in bulk. They are the same as our boxed reels priced at \$59.99!



Special

Any 4 8' or 10'  
**\$80.00**

Any 4 12' or 14'  
**\$100.00**

**Cypress Creek**

**Glass Composite Series**

#CCCR-8' \_\_ 10' \_\_

#CCCR-12' \_\_ 14' \_\_

- Blends quality with affordability
- Glass graphite composite
- Ceramic Guides
- Hi-vis tip

